

## BRIDGE RECTIFIER

### FEATURES

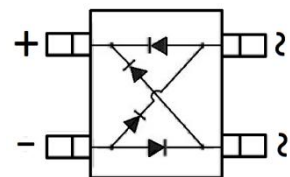
- Low Reverse voltage leakage current
- Glass Passivated Die Construction
- Low Forward Voltage Drop
- High forward surge current capability
- Small Surface Mount device



### MECHANICAL DATA

- Case: ABS
- Case Material: Molded Plastic. UL flammability
- Classification Rating: 94V-0
- Moisture Sensitivity: Level 1 per J-STD-020
- Weight: 0.10 grams (approximate)

ABS



### MAXIMUM RATINGS (T<sub>A</sub> = 25°C unless otherwise noted)

Parameter	Symbol	ABS05	ABS1	ABS2	ABS4	ABS6	ABS8	ABS10	Unit
Repetitive peak reverse voltage	V <sub>RRM</sub>	50	100	200	400	600	800	1000	V
DC Reverse Voltage	V <sub>R</sub>	50	100	200	400	600	800	1000	V
RMS Reverse Voltage	V <sub>RMS</sub>	35	70	140	280	420	560	700	V
Mean rectifying current(Note1)	I <sub>F</sub>	1.0							A
Non-Repetitive Peak Forward Surge Current @ t = 8.3 ms	I <sub>FSM</sub>	35							A
Thermal Resistance From Junction To Ambient	R <sub>θJA</sub>	80							°C/W
Junction Temperature	T <sub>J</sub>	-55 ~+150							°C
Storage Temperature	T <sub>STG</sub>	-55 ~+150							°C

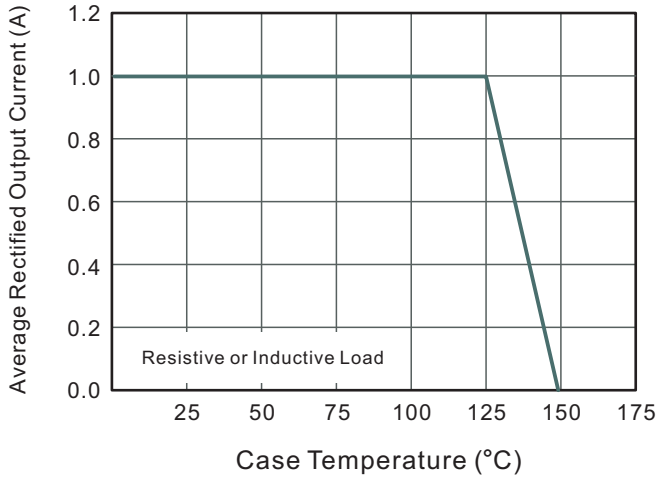
### ELECTRICAL CHARACTERISTICS (T<sub>A</sub> = 25°C unless otherwise specified)

Parameter	Symbol	Min	Max	Unit	Conditions
Forward voltage	V <sub>F</sub>		1.0	V	I <sub>F</sub> =0.5A
Forward voltage	V <sub>F</sub>		1.1	V	I <sub>F</sub> =1.0A
Reverse current T=25°C	I <sub>R</sub>		5	uA	V <sub>R</sub> =1000V
Reverse current T=125°C	I <sub>R</sub>		100	uA	V <sub>R</sub> =1000V
Junction capacitance	C <sub>J</sub>		10	pF	V=4V <sub>DC</sub> ,f=1MH

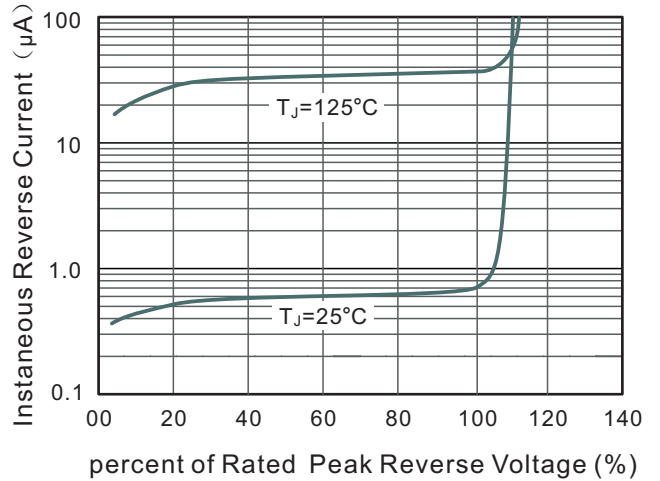
**BRIDGE RECTIFIER**

**Typical Characteristics**

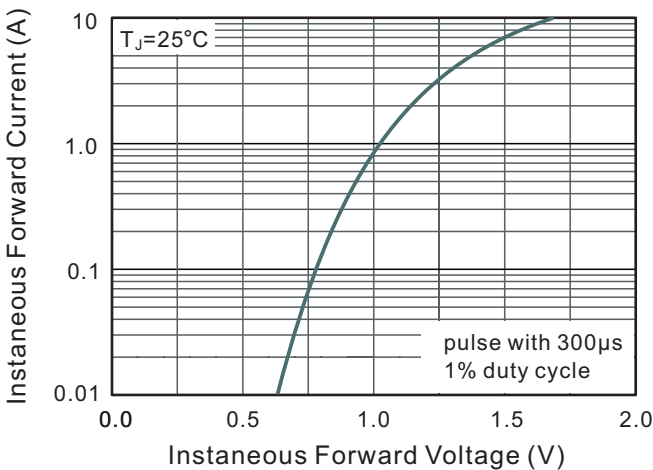
**Fig.1 Average Rectified Output Current Derating Curve**



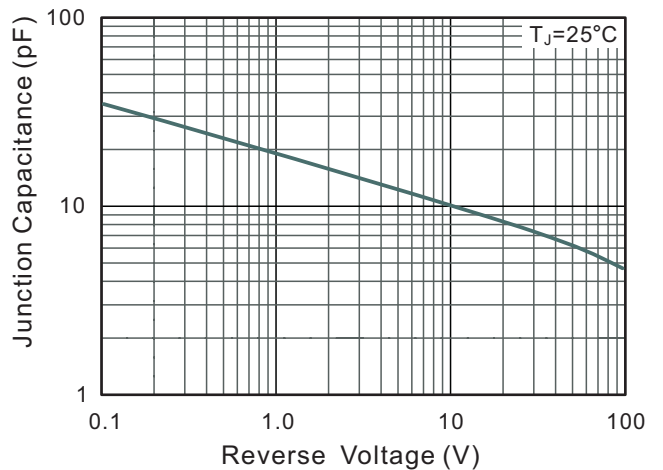
**Fig.2 Typical Reverse Characteristics**



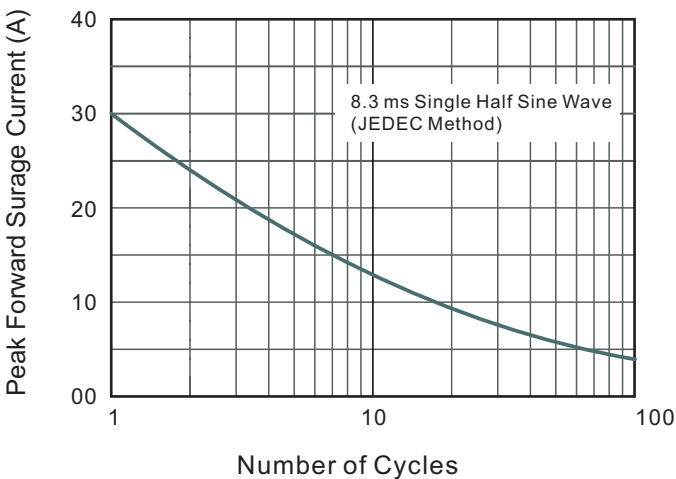
**Fig.3 Typical Instantaneous Forward Characteristics**



**Fig.4 Typical Junction Capacitance**

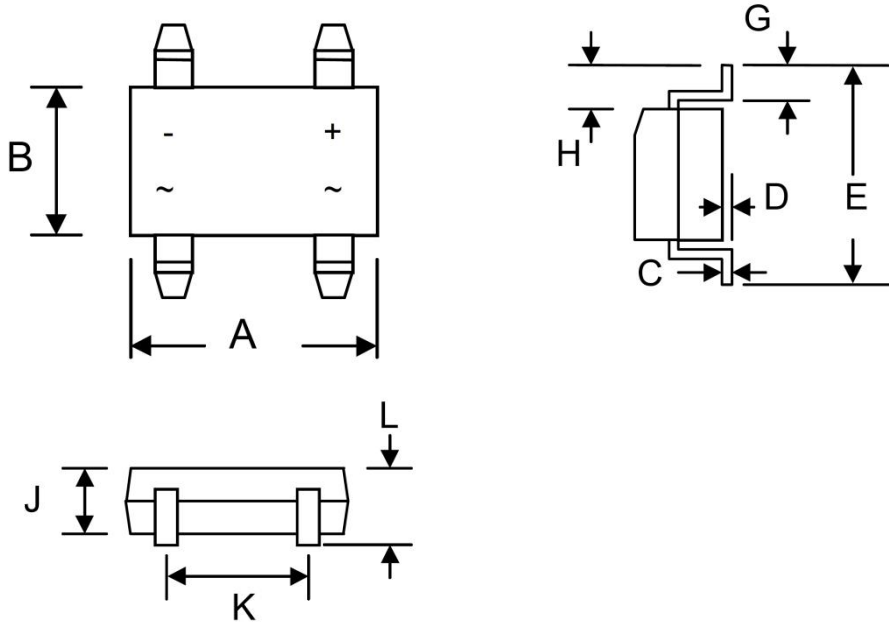


**Fig.5 Maximum Non-Repetitive Peak Forward Surge Current**



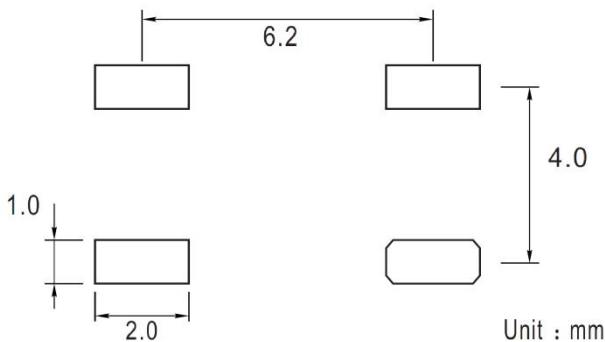
BRIDGE RECTIFIER

**ABS Package Outline Dimensions**



Symbol	Dimensions In Millimeters		Dimensions In Inches	
	Min.	Max.	Min.	Max.
A	4.80	5.30	0.189	0.209
B	4.20	4.60	0.165	0.181
C	0.15	0.25	0.006	0.010
D	-----	0.20	—	0.008
E	6.00	6.80	0.236	0.268
G	0.30	0.70	0.012	0.028
H	0.90	1.10	0.035	0.043
J	—	1.50	—	0.059
K	3.80	4.20	0.150	0.165
L	1.22	1.72	0.048	0.068

**ABS Suggested Pad Layout**



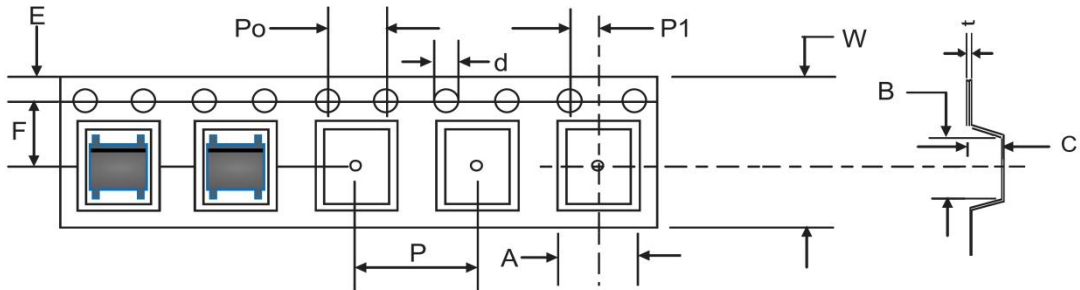
**Note:**

1. Controlling dimension: in millimeters
2. General tolerance:  $\pm 0.05\text{mm}$
3. The pad layout is for reference purposes only

BRIDGE RECTIFIER

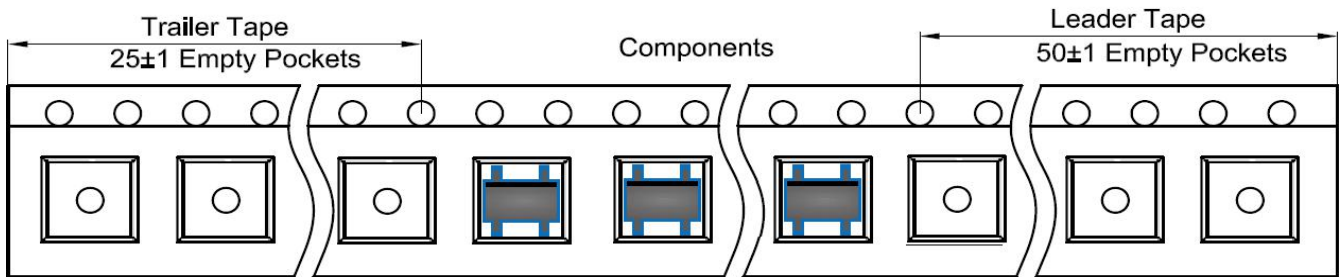
**ABS Tape and Reel**

**ABS Embossed Carrier Tape**

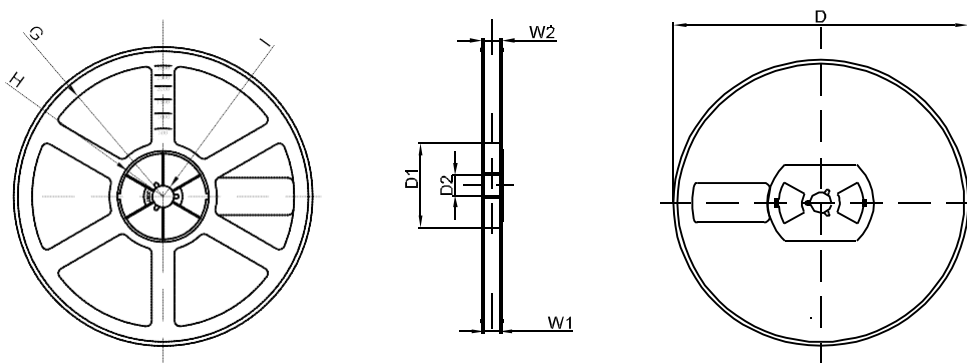


DIMENSIONS ARE IN MILLIMETER										
TYPE	A	B	C	d	E	F	P <sub>0</sub>	P	P <sub>1</sub>	W
ABS	5.31	6.68	1.85	Ø1.50	1.75	5.50	4.00	8.00	2.00	12.00
TOLERANCE	±0.1	±0.1	±0.1	±0.1	±0.1	±0.1	±0.1	±0.1	±0.1	±0.1

**ABS Tape Leader and Trailer**



**ABS Reel**



DIMENSIONS ARE IN MILLIMETER								
REEL OPTION	D	D1	D2	G	H	I	W1	W2
13" DIA	Ø330	75.0	13.00	R165	R37.50	R6.50	12.40	17.60
TOLERANCE	±2	±1	±1	±1	±1	±1	±1	±1

## X-ON Electronics

Largest Supplier of Electrical and Electronic Components

*Click to view similar products for [Bridge Rectifiers](#) category:*

*Click to view products by [Hottech](#) manufacturer:*

Other Similar products are found below :

[MB2510](#) [MB252](#) [MB356G](#) [MB358G](#) [MP358-BP](#) [90MT160KPBF](#) [GBJ1504-BP](#) [GBU10B-BP](#) [GBU15J-BP](#) [GBU15K-BP](#) [GBU4A-BP](#)  
[GBU4D-BP](#) [GSIB680-E3/45](#) [DB101-BP](#) [DF01](#) [DF10SA-E345](#) [BU1508-E3/45](#) [BU1510-E3/45](#) [KBPC50-10S](#) [RS405GL-BP](#) [G5SBA60-](#)  
[E3/51](#) [GBJ1502-BP](#) [GBU10J-BP](#) [GBU4J-BP](#) [GBU6M](#) [GBU8D-BP](#) [GBU8J-BP](#) [GSIB1520-E3/45](#) [TB102M](#) [MB1510](#) [MB6M-G](#) [MB86](#)  
[TL401G](#) [MDA920A2](#) [TU602](#) [TU810](#) [MP501W-BP](#) [MP502-BP](#) [BR1005-BP](#) [BR101-BP](#) [BR84DTP204](#) [BU1010A-E3/51](#) [BU1508-E3/51](#)  
[BU2006-E3/45](#) [BU2008-E3/51](#) [US15KB80R-7000](#) [KBPC25-02](#) [VS-60MT120KPBF](#) [DB105-BP](#) [DF1510S](#)