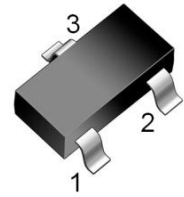

ZENER DIODE

FEATURES

- Planar Die Construction
- 300mW Power Dissipation
- Surface Mount device

**SOT-23****MECHANICAL DATA**

- Case: SOT-23
- Case Material: Molded Plastic. UL flammability
- Classification Rating: 94V-0
- Weight: 0.008 grams (approximate)

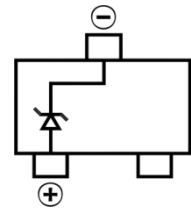
**MAXIMUM RATINGS (T_A = 25°C unless otherwise noted)**

Parameter	Symbol	Value	Unit
Maximum Forward Voltage @ I _F = 10mA	V _F	0.9	V
Power Dissipation	P _D	350	mW
Thermal Resistance From Junction To Ambient(Note1)	R _{θJA}	417	°C/W
Junction and Storage Temperature Range	T _J , T _{STG}	-65 ~ +150	°C

Note1: Alumina = 0.4 X 0.3 X 0.024 in, 99.5% alumina

ZENER DIODE
ELECTRICAL CHARACTERISTICS (T_A = 25°C unless otherwise specified)

f = 1kHz	Zener Voltage Range(Note2)			Maximum Zener Impedance(Note3)			Zener Voltage Range(Note2)				Zener Impedance		Reverse		Forward	
	V _Z @ I _{ZT}		I _{ZT}	Z _{ZT} @ I _{ZT}	Z _{ZK} @ I _{ZK}	I _{ZK}	V _{Z2} @ I _{Z2}	I _{Z2}	V _{Z3} @ I _{Z3}	I _{Z3}	Z _{ZT3} @ I _{ZT3}		I _R	V _R	I _F	V _F
TYPE	Nom(V)	Range(V)	(mA)	Ω	(mA)	(V)	(mA)	(V)	(mA)	Ω	(mA)	(uA)	(V)	(mA)	(V)	
BZX84C2V0	2.0	1.8~2.0	5	100	-	-	-	-	-	-	-	120	0.5	-	-	
BZX84C2V2	2.2	2.08~2.2	5	100	-	-	-	-	-	-	-	120	0.7	-	-	
BZX84C2V4	2.4	2.2~2.6	5	100	600	1.0	1.7~2.1	1.0	2.6~3.2	20	50	20	50	1.0	10	0.9
BZX84C2V7	2.7	2.5~2.9	5	100	600	1.0	1.9~2.4	1.0	3~3.6	20	50	20	20	1.0	10	0.9
BZX84C3V0	3.0	2.8~3.2	5	95	600	1.0	2.1~2.7	1.0	3.3~3.9	20	50	20	10	1.0	10	0.9
BZX84C3V3	3.3	3.1~3.5	5	95	600	1.0	2.3~2.9	1.0	3.6~4.2	20	40	20	5	1.0	10	0.9
BZX84C3V6	3.6	3.4~3.8	5	90	600	1.0	2.7~3.3	1.0	3.9~4.5	20	40	20	5	1.0	10	0.9
BZX84C3V9	3.9	3.7~4.1	5	90	600	1.0	2.9~3.5	1.0	4.1~4.7	20	30	20	3	1.0	10	0.9
BZX84C4V3	4.3	4.0~4.6	5	90	600	1.0	3.3~4	1.0	4.4~5.1	20	30	20	3	1.0	10	0.9
BZX84C4V7	4.7	4.4~5.0	5	80	500	1.0	3.7~4.7	1.0	4.5~5.4	20	15	20	3	2.0	10	0.9
BZX84C5V1	5.1	4.8~5.4	5	60	480	1.0	4.2~5.3	1.0	5~5.9	20	15	20	2	2.0	10	0.9
BZX84C5V6	5.6	5.2~6.0	5	40	400	1.0	4.8~6	1.0	5.2~6.3	20	10	20	1	2.0	10	0.9
BZX84C6V2	6.2	5.8~6.6	5	10	150	1.0	5.6~6.6	1.0	5.8~6.8	20	6	20	3	4.0	10	0.9
BZX84C6V8	6.8	6.4~7.2	5	15	80	1.0	6.3~7.2	1.0	6.4~7.4	20	6	20	2	4.0	10	0.9
BZX84C7V5	7.5	7.0~7.9	5	15	80	1.0	6.9~7.9	1.0	7~8	20	6	20	1	5.0	10	0.9
BZX84C8V2	8.2	7.7~8.7	5	15	80	1.0	7.6~8.7	1.0	7.7~8.8	20	6	20	0.7	5.0	10	0.9
BZX84C9V1	9.1	8.5~9.6	5	15	100	1.0	8.4~9.6	1.0	8.5~9.7	20	8	20	0.5	6.0	10	0.9
BZX84C10	10	9.4~10.6	5	20	150	1.0	9.3~10.6	1.0	9.4~10.7	20	10	20	0.2	7.0	10	0.9
BZX84C11	11	10.4~11.6	5	20	150	1.0	10.2~11.6	1.0	10.4~11.8	20	10	20	0.1	8.0	10	0.9
BZX84C12	12	11.4~12.7	5	25	150	1.0	11.2~12.7	1.0	11.4~12.9	20	10	20	0.1	8.0	10	0.9
BZX84C13	13	12.4~14.1	5	30	170	1.0	12.3~14	1.0	12.5~14.2	20	15	20	0.1	8.0	10	0.9
BZX84C15	15	13.8~15.6	5	30	200	1.0	13.7~15.5	1.0	13.9~15.7	20	20	20	0.05	10.5	10	0.9
BZX84C16	16	15.3~17.1	5	40	200	1.0	15.2~17	1.0	15.4~17.2	20	20	20	0.05	11.2	10	0.9
BZX84C18	18	16.8~19.1	5	45	225	1.0	16.7~19	1.0	16.9~19.2	20	20	20	0.05	12.6	10	0.9
BZX84C20	20	18.8~21.2	5	55	225	1.0	18.7~21.1	1.0	18.9~21.4	20	20	20	0.05	14.0	10	0.9
BZX84C22	22	20.8~23.3	5	55	250	1.0	20.7~23.2	1.0	20.9~23.4	20	25	20	0.05	15.4	10	0.9
BZX84C24	24	22.8~25.6	5	70	250	1.0	22.7~25.5	1.0	22.9~25.7	20	25	20	0.05	16.8	10	0.9
BZX84C27	27	25.1~28.9	2	80	300	0.5	25~28.9	0.1	25.2~29.3	10	45	10	0.05	18.9	10	0.9
BZX84C30	30	28~32	2	80	300	0.5	27.8~32	0.1	28.1~32.4	10	50	10	0.05	21	10	0.9
BZX84C33	33	31~35	2	80	325	0.5	30.8~35	0.1	31.1~35.4	10	55	10	0.05	23.1	10	0.9
BZX84C36	36	34~38	2	90	350	0.5	33.8~38	0.1	34.1~38.4	10	60	10	0.05	25.2	10	0.9
BZX84C39	39	37~41	2	130	350	0.5	36.7~41	0.1	37.1~41.5	10	70	10	0.05	27.3	10	0.9
BZX84C43	43	40~46	2	150	375	0.5	39.7~46	0.1	40.1~46.5	10	80	10	0.05	30.1	10	0.9
BZX84C47	47	44~50	2	170	375	0.5	43.7~50	0.1	44.1~50.5	10	90	10	0.05	32.9	10	0.9
BZX84C51	51	48~54	2	180	400	0.5	47.6~54	0.1	48.1~54.6	10	100	10	0.05	35.7	10	0.9
BZX84C56	56	52~60	2	200	425	0.5	51.5~60	0.1	52.1~60.8	10	110	10	0.05	39.2	10	0.9
BZX84C62	62	58~66	2	215	450	0.5	57.4~66	0.1	58.2~67	10	120	10	0.05	43.4	10	0.9
BZX84C68	68	64~72	2	240	475	0.5	63.4~72	0.1	64.2~73.2	10	130	10	0.05	47.6	10	0.9
BZX84C75	75	70~79	2	255	500	0.5	69.4~79	0.1	70.3~80.2	10	140	10	0.05	52.5	10	0.9

Note: (2) Tested with pulses t_p = 20 ms.

(3) The Zener impedance, Z_{ZK}, for the 27 through 75 volt types is tested at 0.5 mA rather than the test current of 0.1 mA used for V_{Z2}

ZENER DIODE

Typical Characteristics

Zener Characteristics (V_z Up to 10 V)

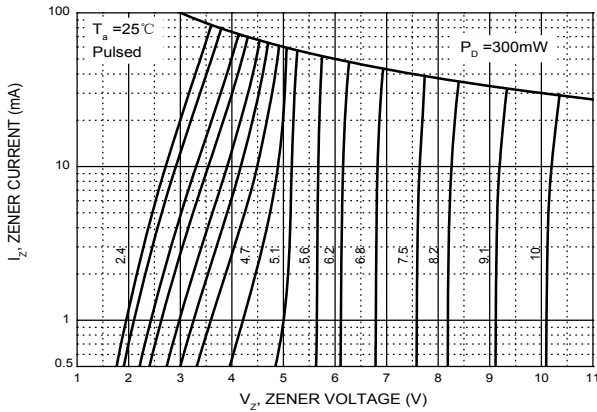

Zener Characteristics (11 V to 43 V)

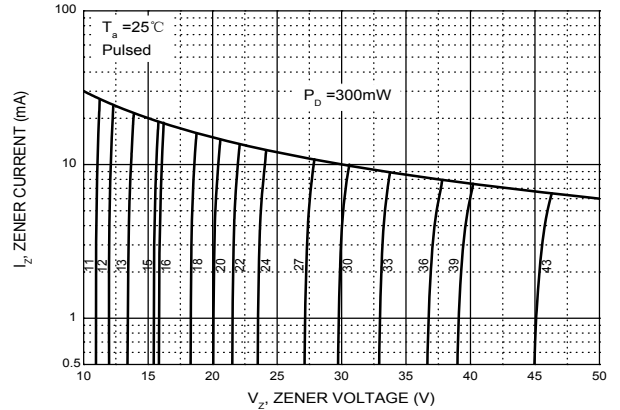

Temperature Coefficients

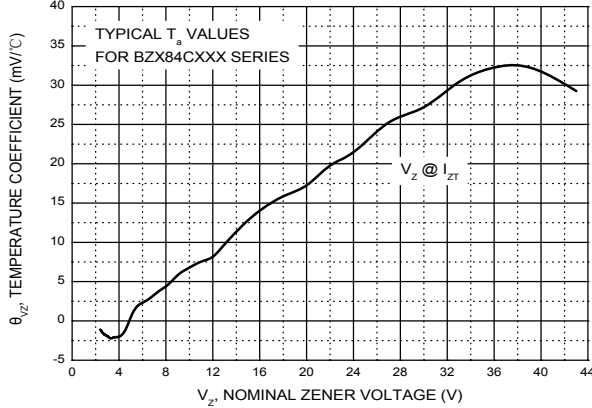

Typical Leakage Current

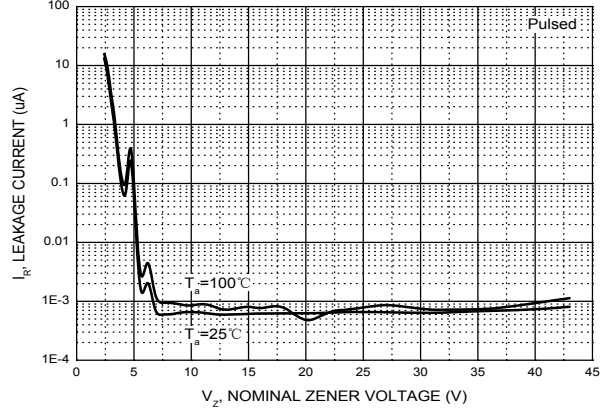

Typical Capacitance

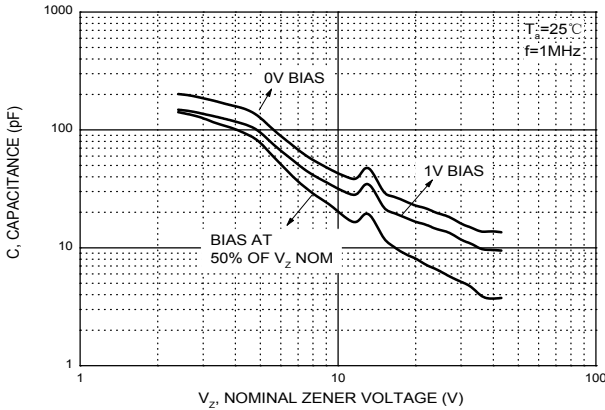

Effect of Zener Voltage on Zener Impedance

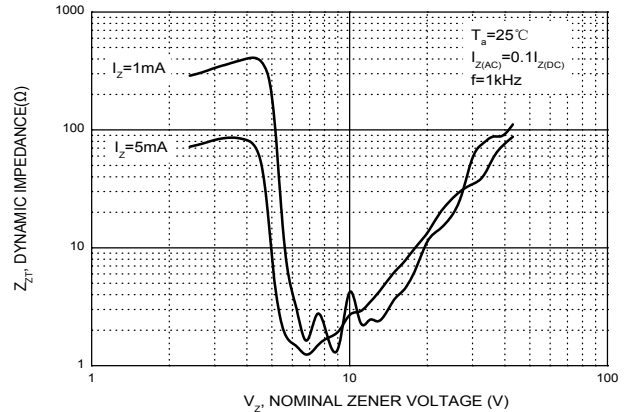

Power Derating Curve

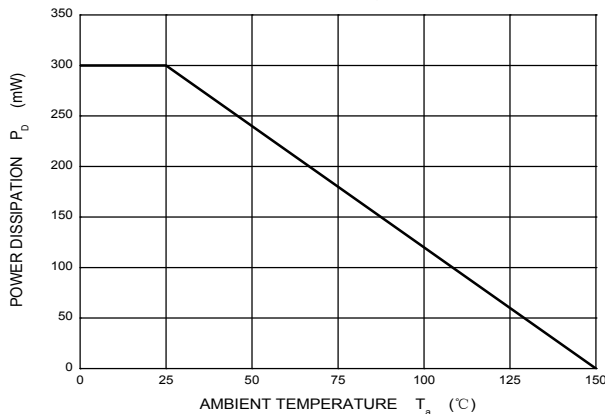

ZENER DIODE

SOT-23 Package Outline Dimensions

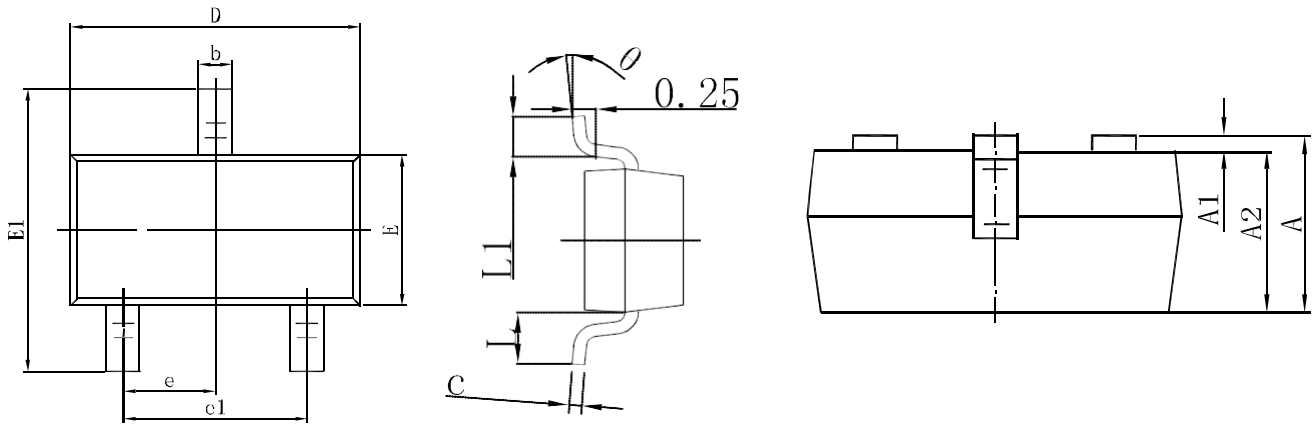

Symbol	Dimensions In Millimeters		Dimensions In Inches	
	Min.	Max.	Min.	Max.
A	0.900	1.150	0.035	0.045
A1	0.000	0.100	0.000	0.004
A2	0.900	1.050	0.035	0.041
b	0.300	0.500	0.012	0.020
c	0.080	0.150	0.003	0.006
D	2.800	3.000	0.110	0.118
E	1.200	1.400	0.047	0.055
E1	2.250	2.550	0.089	0.100
e	0.950 TYP		0.037 TYP	
e1	1.800	2.000	0.071	0.079
L	0.550 REF		0.022 REF	
L1	0.300	0.500	0.012	0.020
θ	0°	8°	0°	8°

SOT-23 Suggested Pad Layout

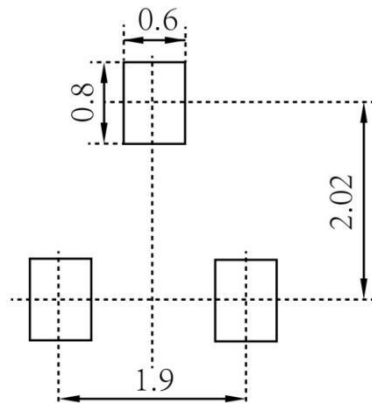

Note:

1. Controlling dimension: in millimeters
2. General tolerance: ±0.05mm
3. The pad layout is for reference purposes only

ZENER DIODE

SOT-23 Tape and Reel

SOT-23 Embossed Carrier Tape

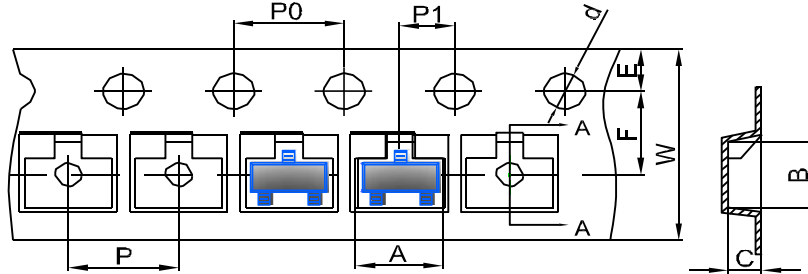

DIMENSIONS ARE IN MILLIMETER										
TYPE	A	B	C	d	E	F	P0	P	P1	W
SOT-23	3.15	2.77	1.22	Ø1.50	1.75	3.50	4.00	4.00	2.00	8.00
TOLERANCE	±0.1	±0.1	±0.1	±0.1	±0.1	±0.1	±0.1	±0.1	±0.1	±0.1

SOT-23 Tape Leader and Trailer

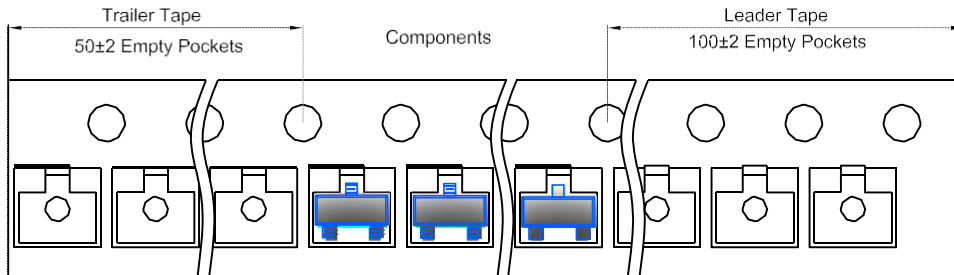

SOT-23 Reel

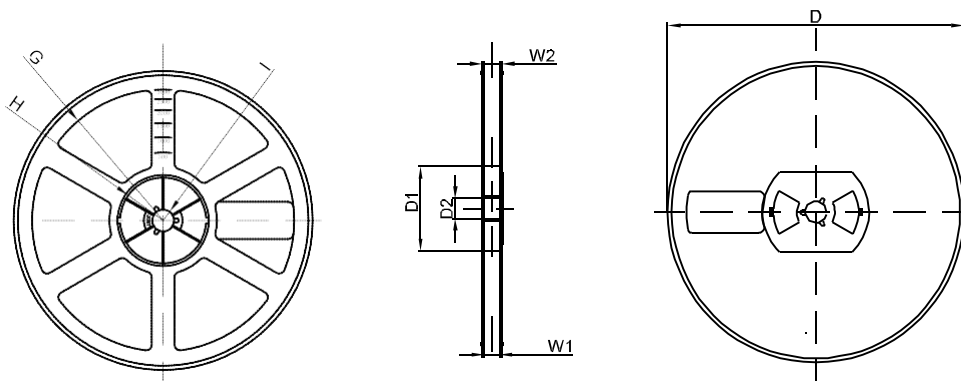

DIMENSIONS ARE IN MILLIMETER								
REEL OPTION	D	D1	D2	G	H	I	W1	W2
7" DIA	Ø178	54.40	13.00	R78	R25.60	R6.50	9.50	12.30
TOLERANCE	±2	±1	±1	±1	±1	±1	±1	±1

X-ON Electronics

Largest Supplier of Electrical and Electronic Components

Click to view similar products for [Zener Diodes](#) category:

Click to view products by [Hottech](#) manufacturer:

Other Similar products are found below :

[RKZ13B2KG#P1](#) [DL5234B](#) [EDZTE6113B](#) [1N4682](#) [1N4691](#) [1N4693](#) [1N4732A](#) [1N4736A](#) [1N4750A](#) [1N4759ARL](#) [1N5241B](#) [1N5365B](#)
[1N5369B](#) [1N747A](#) [1N959B](#) [1N964B](#) [1N966B](#) [1N968B](#) [1N972B](#) [NTE5121A](#) [NTE5147A](#) [NTE5152A](#) [NTE5155A](#) [NTE5164A](#)
[JANS1N4974US](#) [JANTX1N5907](#) [1N4692](#) [1N4700](#) [1N4702](#) [1N4704](#) [1N4711](#) [1N4714](#) [1N4737A](#) [1N4745ARL](#) [1N4752A](#) [1N4752ARL](#)
[1N4760ARL](#) [1N5221B](#) [1N5231B-TR](#) [1N5236B](#) [1N5241BTR](#) [1N5242BTR](#) [1N5350B](#) [1N5352B](#) [1N961BRR1](#) [1N964BRL](#) [RKZ5.1BKU#P6](#)
[3SMAJ5946B-TP](#) [3SMAJ5950B-TP](#) [3SMBJ5925B-TP](#)