

**FEATURES**

- Glass Passivated Die Construction
- Super-Fast Recovery Time For High Efficiency
- Low Forward Voltage Drop and High Current Capability
- Ideally Suited for Automated Assembly
- Plastic Material: UL Flammability Classification Rating 94V-0



SMAF

**MECHANICAL DATA**

- Case: SMAF Molded plastic
- Terminals: Pure tin plated, lead free
- Polarity: Indicated by cathode band
- Weight: 27mg (approx.)



Cathode

**MAXIMUM RATINGS AND ELECTRICAL CHARACTERISTICS**

Ratings at 25 °C ambient temperature unless otherwise specified. Single phase, half wave, 60 Hz, resistive or inductive load. For capacitive load, derate current by 20%.

Parameter	Symbol	ES1AF	ES1BF	ES1CF	ES1DF	ES1EF	ES1GF	ES1JF	Unit	
Maximum Repetitive Peak Reverse Voltage	$V_{RRM}$	50	100	150	200	300	400	600	V	
Maximum RMS Voltage	$V_{RMS}$	35	70	105	140	210	280	420	V	
Maximum DC Blocking Voltage	$V_{DC}$	50	100	150	200	300	400	600	V	
Maximum Average Forward Rectified Current at $T_A = 75\text{ °C}$	$I_{F(AV)}$	1.0							A	
Peak Forward Surge Current 8.3ms Single Half Sine-wave Superimposed on Rated Load (JEDEC)	$I_{FSM}$	30.0							A	
Maximum Instantaneous Forward Voltage at 1 A	$V_F$	0.95				1.25		1.7	V	
Maximum DC Reverse Current at Rated DC Blocking Voltage	$I_R$	$T_A = 25\text{ °C}$							5.0	$\mu\text{A}$
		$T_A = 100\text{ °C}$							100.0	
Maximum reverse recovery time (NOTE1)	$t_{rr}$	35							nS	
Typical Junction Capacitance (NOTE2)	$C_J$	15.0							pF	
Maximum Thermal Resistance (NOTE3)	$R_{\theta JL}$	60.0							$^{\circ}\text{C/W}$	
Operating and Storage Temperature Range	$T_{J, TS}$	- 50 to + 150							$^{\circ}\text{C}$	

Note: 1.Reverse recovery condition  $I_F=0.5\text{A}, I_R=1.0\text{A}, I_{rr}=0.25\text{A}$

2.Measured at 1MHz and applied reverse voltage of 4.0V D.C.

3.P.C.B. mounted with 0.2x0.2"(5.0x5.0mm) copper pad areas

**Typical Characteristics**

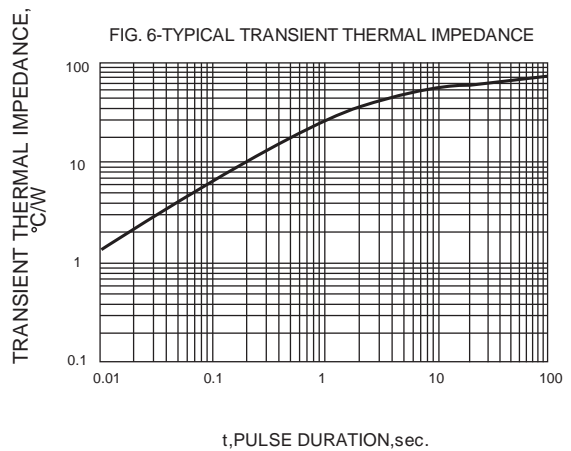
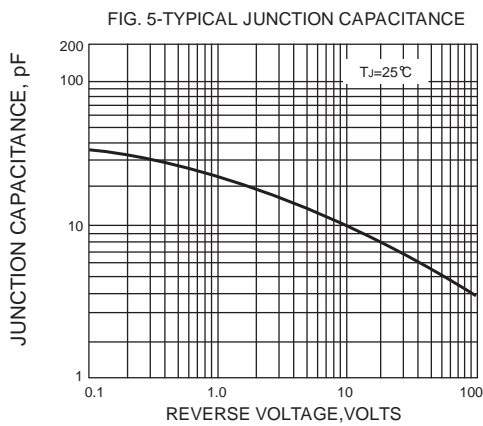
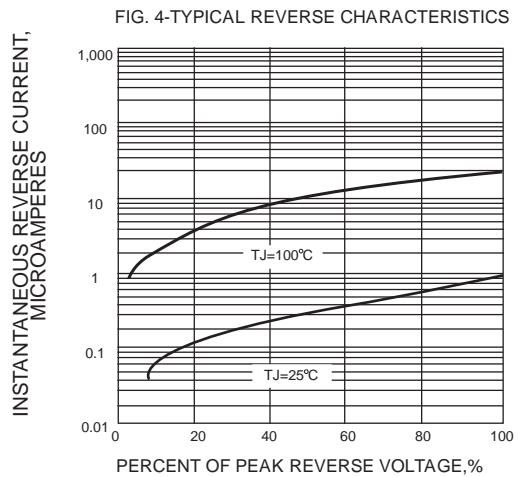
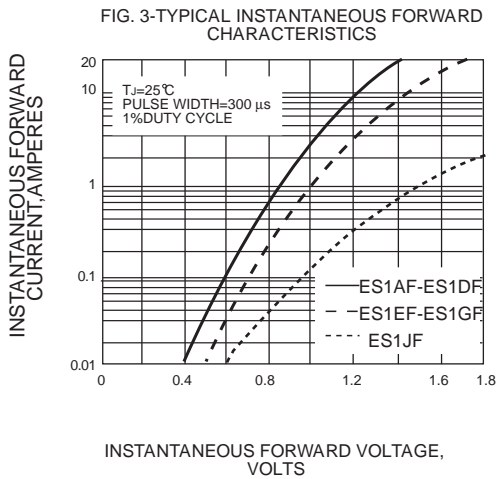
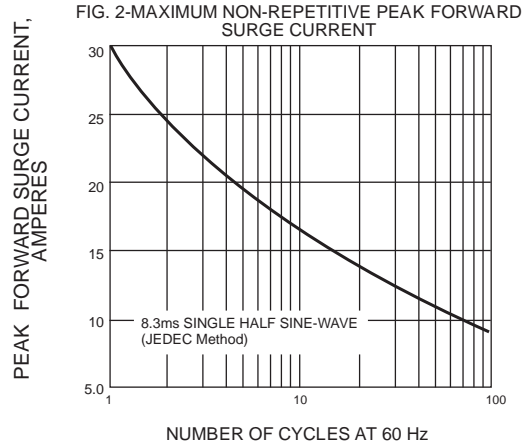
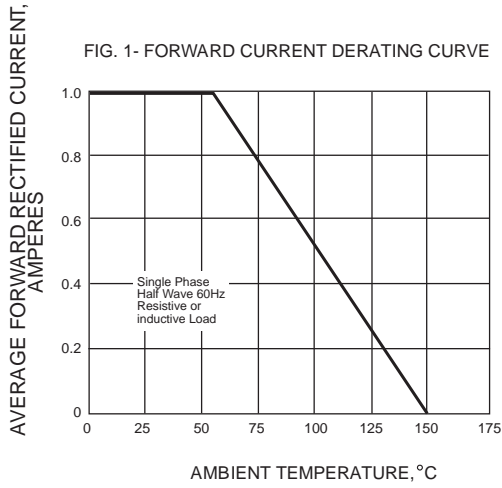

**SMAF Package Outline Dimensions**

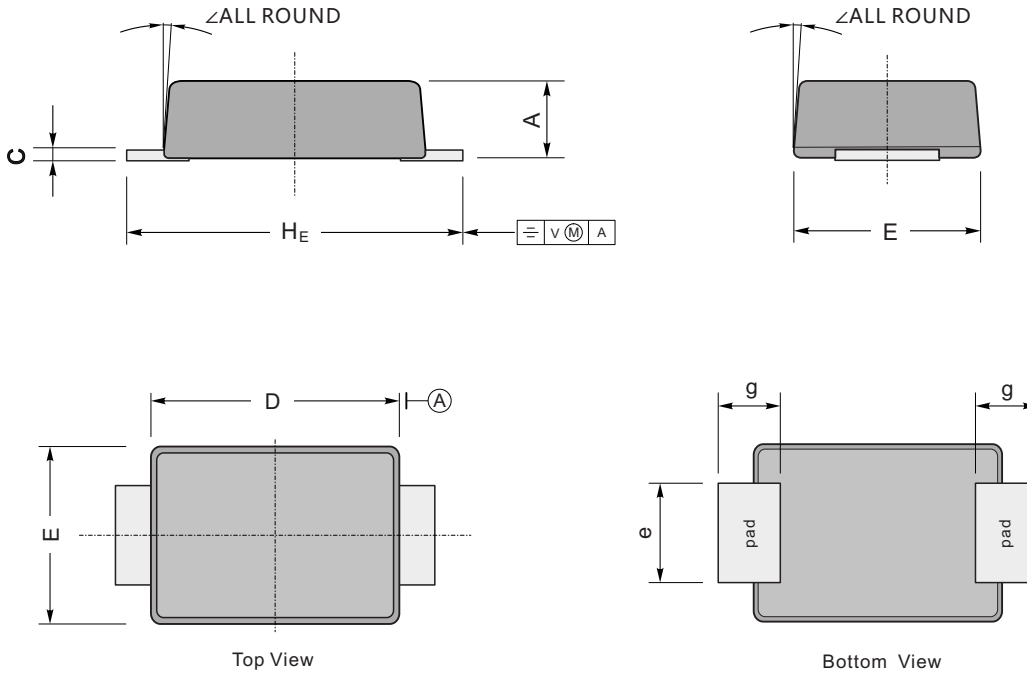

UNIT		A	C	D	E	e	g	H <sub>E</sub>	∠
mm	max	1.1	0.20	3.7	2.7	1.6	1.2	4.9	7°
	min	0.9	0.12	3.3	2.4	1.3	0.8	4.4	
mil	max	43	7.9	146	106	63	47	193	
	min	35	4.7	130	94	51	31	173	

## X-ON Electronics

Largest Supplier of Electrical and Electronic Components

*Click to view similar products for [Rectifiers](#) category:*

*Click to view products by [Hottech](#) manufacturer:*

Other Similar products are found below :

[70HFR40](#) [FR105 R0](#) [RL252-TP](#) [DLA11C-TR-E](#) [DSA17G](#) [150KR30A](#) [1N5397](#) [1N4002G](#) [1N4005-TR](#) [UFS120Je3/TR13](#) [JANS1N6640US](#)  
[481235F](#) [RRE02VS6SGTR](#) [067907F](#) [MS306](#) [70HF40](#) [T110HF60](#) [T85HFL60S02](#) [US2JFL-TP](#) [A1N5404G-G](#) [CRS04\(T5L,TEMQ\)](#)  
[CRS12\(T5L,TEMQ\)](#) [ACGRB207-HF](#) [CLH07\(TE16L,Q\)](#) [CLH03\(TE16L,Q\)](#) [ACGRC307-HF](#) [ACEFC304-HF](#) [NTE6356](#) [NTE6359](#) [85HFR60](#)  
[40HFR60](#) [70HF120](#) [85HFR80](#) [D126A45C](#) [SCF7500](#) [D251N08B](#) [SCHJ22.5K](#) [SM100](#) [SCPA2](#) [SDHD5K](#) [VS-12FL100S10](#) [ACGRA4001-](#)  
[HF](#) [ACURA107-HF](#) [D1821SH45T PR](#) [D1251S45T](#) [NTE6358](#) [NTE5850](#) [NTE5819](#) [NTE5837](#) [NTE5892](#)