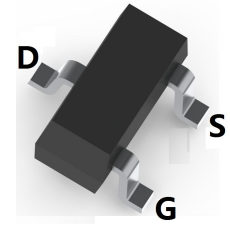
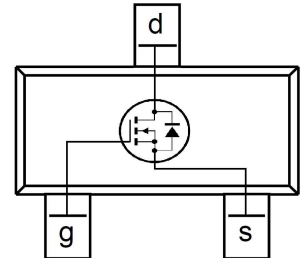

MOSFET (N-CHANNEL)
FEATURES

- Fast switching
- Ultra Low On-Resistance
- Surface Mount device

SOT-23

MECHANICAL DATA

- Case: SOT-23
- Case Material: Molded Plastic. UL flammability
- Classification Rating: 94V-0
- Weight: 0.008 grams (approximate)

MAXIMUM RATINGS (T_A = 25°C unless otherwise noted)

Parameter	Symbol	Value	Unit
Drain-source voltage	V _{DS}	20	V
Gate-source voltage	V _{GS}	±12	V
Continuous drain current	I _D	4.2	A
Pulsed drain current (Note 1)	I _{DM}	33	A
Power dissipation	P _D	1.25	W
Thermal resistance from Junction to ambient	R _{θJA}	100	°C/W
Junction temperature	T _J	150	°C
Storage temperature	T _{STG}	-55 ~+150	°C

ELECTRICAL CHARACTERISTICS (T_A = 25°C unless otherwise specified)

Parameter	Symbol	Min	Typ	Max	Unit	Conditions
Drain-Source breakdown voltage	V _{(BR)DSS}	20			V	V _{GS} =0V, I _D =250μA
Zero gate voltage drain current	I _{DSS}			1	μA	V _{DS} =16V, V _{GS} =0V
Gate-body leakage current	I _{GSS}			±100	nA	V _{DS} =0V, V _{GS} =±12V
Gate-threshold voltage (note 1)	V _{GS(th)}	0.6		1.2	V	V _{DS} =V _{GS} , I _D =250μA
Drain-source on-resistance (note 1)	R _{DS(ON)}		35	45	mΩ	V _{GS} =4.5V, I _D =4.2A
			50	80	mΩ	V _{GS} =2.5V, I _D =3.6A
Forward transconductance (note 1)	g _{FS}		2.8		S	V _{DS} =10V, I _D =4.0A
Diode forward voltage (note 1)	V _{SD}			1.2	V	I _S =1.3A, V _{GS} =0V, T _J =25°C
Diode forward current	I _S			1.3	A	
Input capacitance	C _{iSS}		740		pF	V _{DS} =15V, V _{GS} =0V, f=1MHz
Output capacitance	C _{oss}		90		pF	
Reverse transfer capacitance	C _{rSS}		66		pF	
Turn-on delay time	t _{d(on)}		7.5		nS	V _{DD} =10V, I _D =1A, R _{GEN} =6Ω, R _L =10Ω
Turn-on rise time	t _r		10		nS	
Turn-off delay time	t _{d(off)}		54		nS	
Turn-off fall time	t _f		26		nS	
Total gate charge	Q _g		8	12	nC	V _{DS} =10V, V _{GS} =5V, I _D =4A
Gate-source charge	Q _{gs}		1.8	2.7	nC	
Gate-drain charge	Q _{gd}		1.7	2.6	nC	

Note:1. Pulse test ; Pulse width ≤300μs, Duty cycle ≤ 2% .

MOSFET (N-CHANNEL)

Typical Characteristics

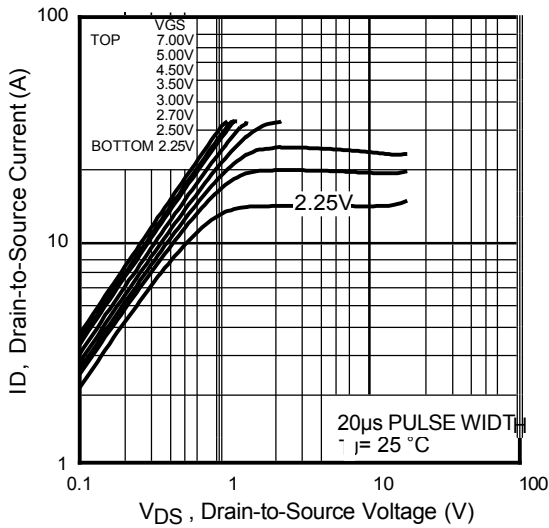

Fig 1. Typical Output Characteristics

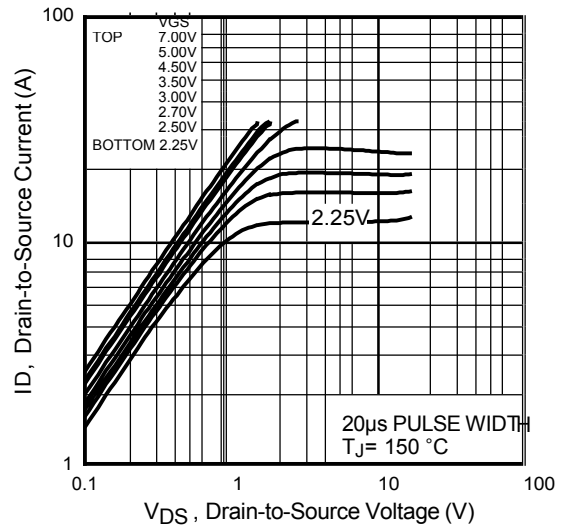

Fig 2. Typical Output Characteristics

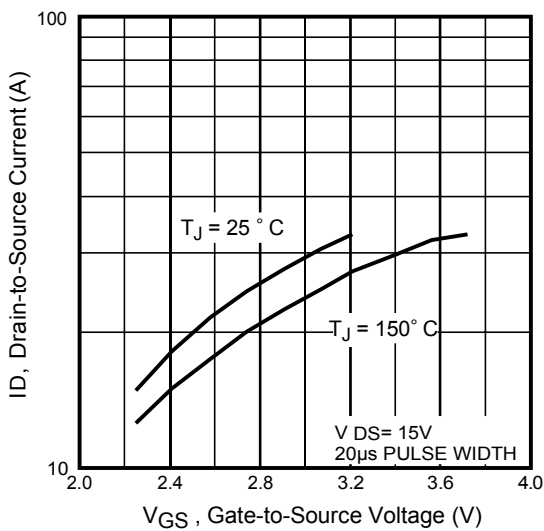

Fig 3. Typical Transfer Characteristics

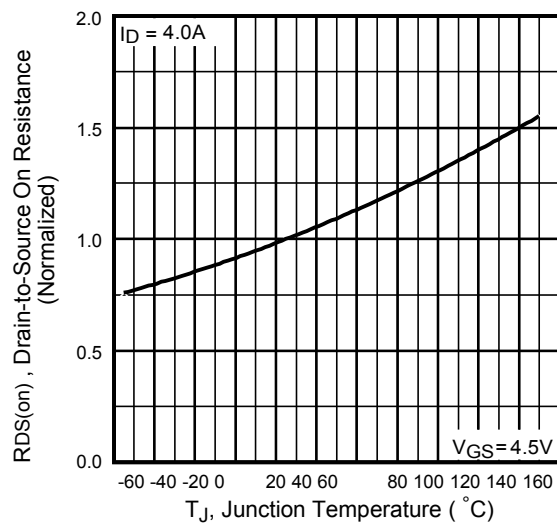

Fig 4. Normalized On-Resistance Vs. Temperature

MOSFET (N-CHANNEL)

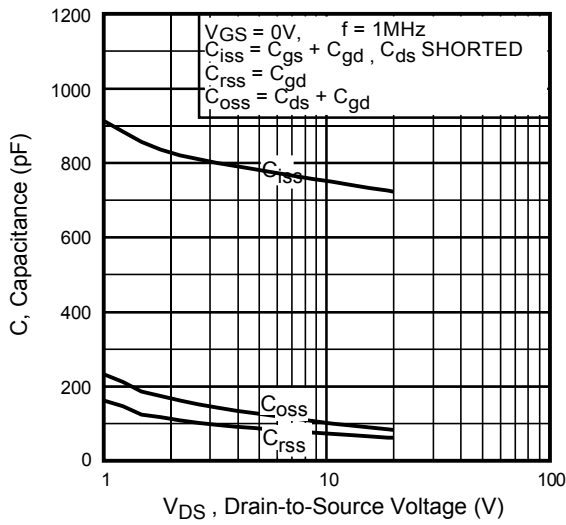

Fig 5. Typical Capacitance Vs. Drain-to-Source Voltage

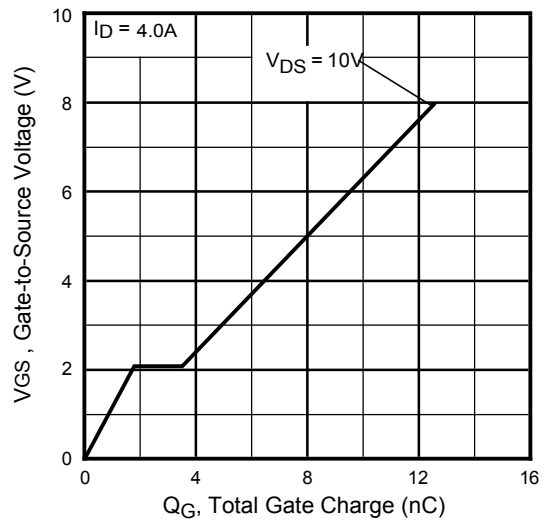

Fig 6. Typical Gate Charge Vs. Gate-to-Source Voltage

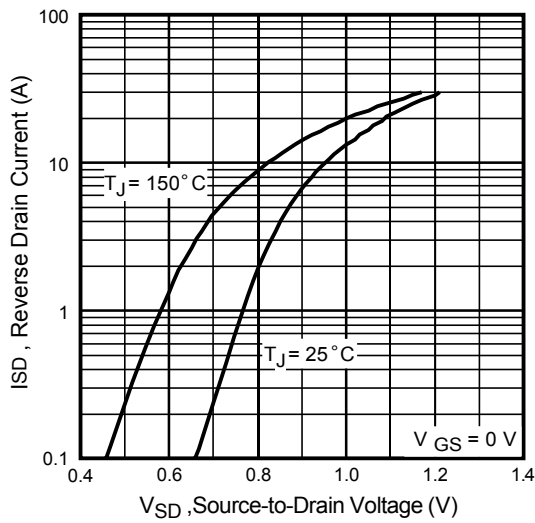

Fig 7. Typical Source-Drain Diode Forward Voltage

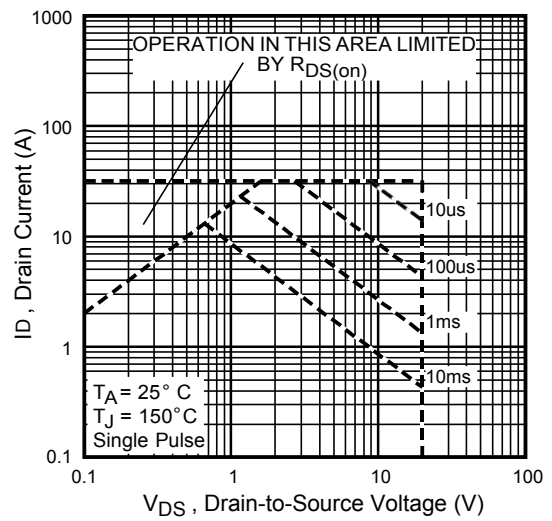

Fig 8. Maximum Safe Operating Area

MOSFET (N-CHANNEL)

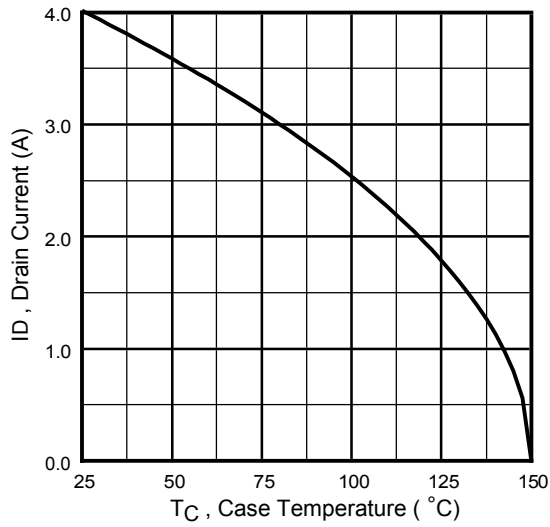

Fig 9. Maximum Drain Current Vs. Case Temperature

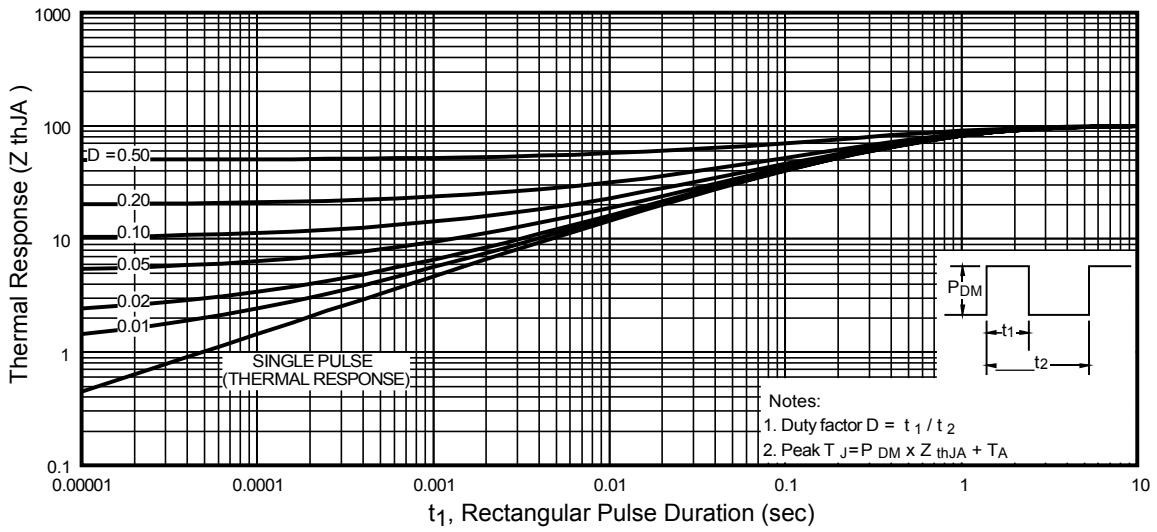
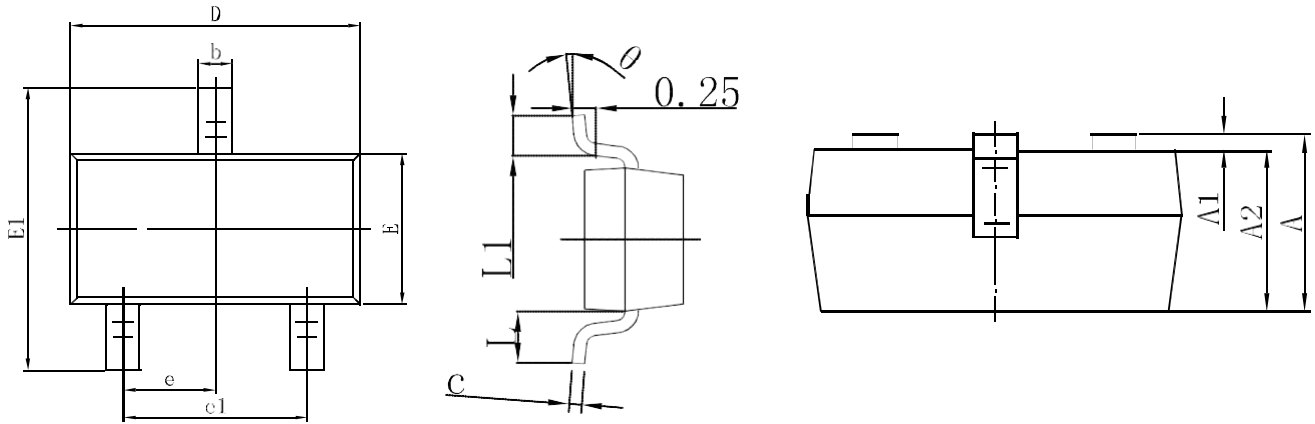

Fig 10. Maximum Effective Transient Thermal Impedance, Junction-to-Ambient

MOSFET (N-CHANNEL)

SOT-23 Package Outline Dimensions



Symbol	Dimensions In Millimeters		Dimensions In Inches	
	Min.	Max.	Min.	Max.
A	0.900	1.150	0.035	0.045
A1	0.000	0.100	0.000	0.004
A2	0.900	1.050	0.035	0.041
b	0.300	0.500	0.012	0.020
c	0.080	0.150	0.003	0.006
D	2.800	3.000	0.110	0.118
E	1.200	1.400	0.047	0.055
E1	2.250	2.550	0.089	0.100
e	0.950 TYP		0.037 TYP	
e1	1.800	2.000	0.071	0.079
L	0.550 REF		0.022 REF	
L1	0.300	0.500	0.012	0.020
θ	0°	8°	0°	8°

SOT-23 Suggested Pad Layout

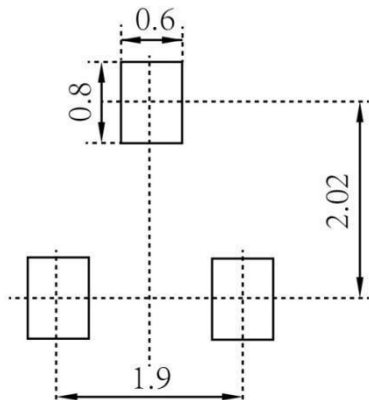

Note:

1. Controlling dimension: in millimeters
2. General tolerance: ±0.05mm
3. The pad layout is for reference purposes only

MOSFET (N-CHANNEL)

SOT-23 Tape and Reel

SOT-23 Embossed Carrier Tape

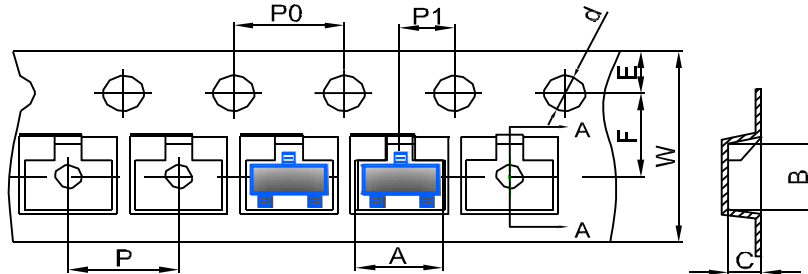

DIMENSIONS ARE IN MILLIMETER										
TYPE	A	B	C	d	E	F	P0	P	P1	W
SOT-23	3.15	2.77	1.22	Ø1.50	1.75	3.50	4.00	4.00	2.00	8.00
TOLERANCE	±0.1	±0.1	±0.1	±0.1	±0.1	±0.1	±0.1	±0.1	±0.1	±0.1

SOT-23 Tape Leader and Trailer

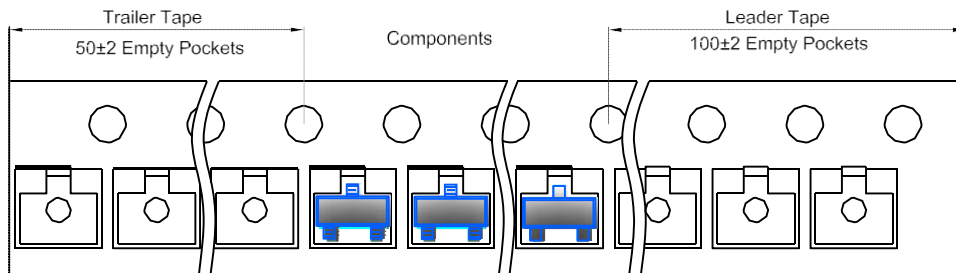

SOT-23 Reel

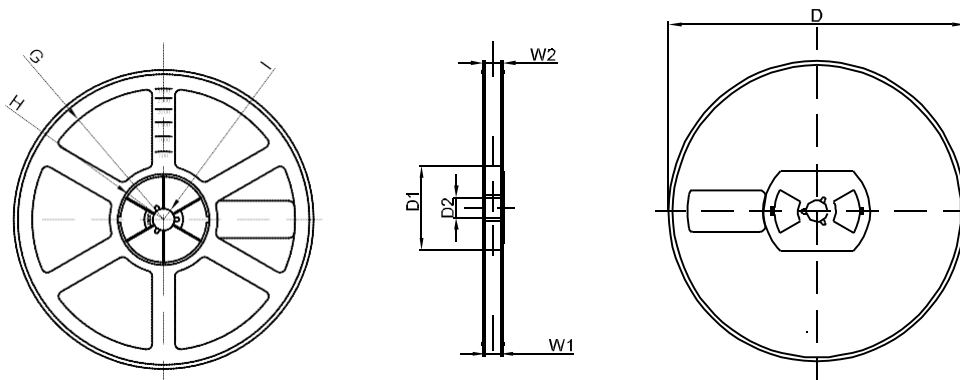

DIMENSIONS ARE IN MILLIMETER								
REEL OPTION	D	D1	D2	G	H	I	W1	W2
7" DIA	Ø178	54.40	13.00	R78	R25.60	R6.50	9.50	12.30
TOLERANCE	±2	±1	±1	±1	±1	±1	±1	±1

X-ON Electronics

Largest Supplier of Electrical and Electronic Components

Click to view similar products for [MOSFET](#) category:

Click to view products by [Hottech](#) manufacturer:

Other Similar products are found below :

[IRFD120](#) [JANTX2N5237](#) [2SK2267\(Q\)](#) [BUK455-60A/B](#) [TK100A10N1,S4X\(S](#) [MIC4420CM-TR](#) [VN1206L](#) [NDP4060](#) [SI4482DY](#)
[IRS2092STRPBF-EL](#) [IPS70R2K0CEAKMA1](#) [SQM120N06-3M5L-GE3](#) [TK31J60W5,S1VQ\(O](#) [TK31J60W,S1VQ\(O](#) [TK16J60W,S1VQ\(O](#)
[2SK2614\(TE16L1,Q\)](#) [DMN1017UCP3-7](#) [EFC2J004NUZTDG](#) [P85W28HP2F-7071](#) [NTE2384](#) [DMC2700UDMQ-7](#) [DMN2080UCB4-7](#)
[DMN61D9UWQ-13](#) [US6M2GTR](#) [DMN31D5UDJ-7](#) [DMP22D4UFO-7B](#) [IPS60R3K4CEAKMA1](#) [DMN1006UCA6-7](#) [DMN16M9UCA6-7](#)
[STF5N65M6](#) [IRF40H233XTMA1](#) [STU5N65M6](#) [DMN6022SSD-13](#) [DMN13M9UCA6-7](#) [DMTH10H4M6SPS-13](#) [IPS60R360PFD7SAKMA1](#)
[DMN2990UFB-7B](#) [SSM3K35CT,L3F](#) [IPLK60R1K0PFD7ATMA1](#) [2N7002W-G](#) [MCAC30N06Y-TP](#) [IPWS65R035CFD7AXKSA1](#)
[MCQ7328-TP](#) [SSM3J143TU,LXHF](#) [PJMF280N65E1_T0_00201](#) [PJMF380N65E1_T0_00201](#) [PJMF280N60E1_T0_00201](#)
[PJMF600N65E1_T0_00201](#) [PJMF900N65E1_T0_00201](#) [PJMF900N60E1_T0_00201](#)