

P-Channel Power MOSFET
FEATURES

- Generation V Technology
- Ultra Low On-Resistance
- Low Profile (<1.1mm)
- Fast Switching

MECHANICAL DATA

- Case: SOT-23
- Case Material: Molded Plastic. UL flammability
- Classification Rating: 94V-0
- Weight: 0.008 grams (approximate)

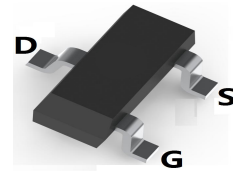
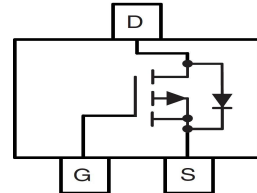

SOT-23

Absolute Maximum Ratings (T_A = 25°C unless otherwise noted)

	Parameter	Max.	Units
V _{DS}	Drain- Source Voltage	-30	V
I _D @ T _A = 25°C	Continuous Drain Current, V _{GS} @ -10V	-3.0	A
I _D @ T _A = 70°C	Continuous Drain Current, V _{GS} @ -10V	-2.4	
I _{DM}	Pulsed Drain Current ①	-24	
P _D @ T _A = 25°C	Power Dissipation	1.25	W
P _D @ T _A = 70°C	Power Dissipation	0.80	
	Linear Derating Factor	10	mW/°C
V _{GS}	Gate-to-Source Voltage	± 20	V
T _J , T _{STG}	Junction and Storage Temperature Range	-55 to + 150	°C
R _{θJA}	Maximum Junction-to-Ambient ③	100	°C/W

Electrical Characteristics @ T_J = 25°C (unless otherwise specified)

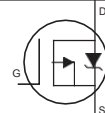
	Parameter	Min.	Typ.	Max.	Units	Conditions
V _{(BR)DSS}	Drain-to-Source Breakdown Voltage	-30	—	—	V	V _{GS} = 0V, I _D = -250μA
ΔV _{(BR)DSS} /ΔT _J	Breakdown Voltage Temp. Coefficient	—	0.019	—	V/°C	Reference to 25°C, I _D = -1mA
R _{DS(on)}	Static Drain-to-Source On-Resistance	—	—	98	mΩ	V _{GS} = -10V, I _D = -3.0A ②
		—	—	165		V _{GS} = -4.5V, I _D = -2.6A ②
V _{GS(th)}	Gate Threshold Voltage	-1.0	—	-2.5	V	V _{DS} = V _{GS} , I _D = -250μA
g _{fs}	Forward Transconductance	3.1	—	—	S	V _{DS} = -10V, I _D = -3.0A
I _{DSS}	Drain-to-Source Leakage Current	—	—	-1.0	μA	V _{DS} = -24V, V _{GS} = 0V
		—	—	-5.0		V _{DS} = -24V, V _{GS} = 0V, T _J = 70°C
I _{GSS}	Gate-to-Source Forward Leakage	—	—	-100	nA	V _{GS} = -20V
	Gate-to-Source Reverse Leakage	—	—	100		V _{GS} = 20V
Q _g	Total Gate Charge	—	9.5	14	nC	I _D = -3.0A
Q _{gs}	Gate-to-Source Charge	—	2.3	3.5		V _{DS} = -24V
Q _{gd}	Gate-to-Drain ("Miller") Charge	—	1.6	2.4		V _{GS} = -10V ②
t _{d(on)}	Turn-On Delay Time	—	12	—	ns	V _{DD} = -15V ②
t _r	Rise Time	—	18	—		I _D = -1.0A
t _{d(off)}	Turn-Off Delay Time	—	88	—		R _G = 6.0Ω
t _f	Fall Time	—	52	—		V _{GS} = -10V
C _{iss}	Input Capacitance	—	510	—	pF	V _{GS} = 0V
C _{oss}	Output Capacitance	—	71	—		V _{DS} = -25V
C _{rss}	Reverse Transfer Capacitance	—	43	—		f = 1.0MHz

Source-Drain Ratings and Characteristics

	Parameter	Min.	Typ.	Max.	Units	Conditions
I _S	Continuous Source Current (Body Diode)	—	—	-1.3	A	MOSFET symbol showing the integral reverse p-n junction diode. 
I _{SM}	Pulsed Source Current (Body Diode) ①	—	—	-24		
V _{SD}	Diode Forward Voltage	—	—	-1.2	V	T _J = 25°C, I _S = -1.3A, V _{GS} = 0V ②
t _{rr}	Reverse Recovery Time	—	17	26	ns	T _J = 25°C, I _F = -1.3A
Q _{rr}	Reverse Recovery Charge	—	12	18	nC	di/dt = -100A/μs ②

Notes: ① Repetitive rating; pulse width limited by max. junction temperature.

② Pulse width ≤ 400μs; duty cycle ≤ 2%.

③ Surface mounted on FR-4 board, t ≤ 5sec.

P-Channel Power MOSFET

Typical Characteristics

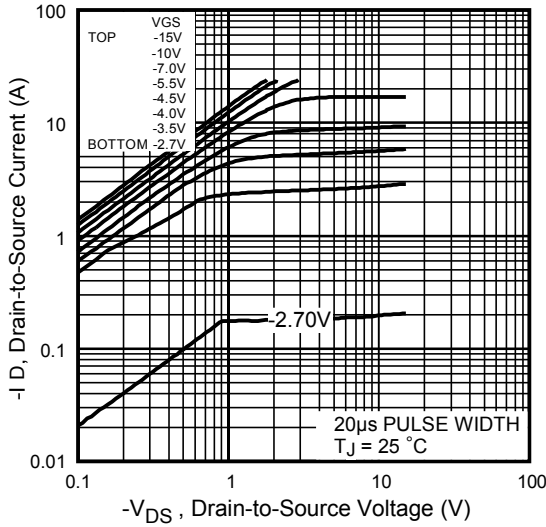

Fig 1. Typical Output Characteristics

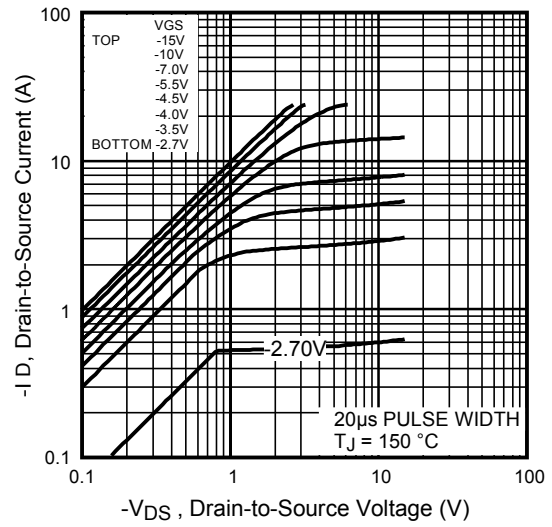

Fig 2. Typical Output Characteristics

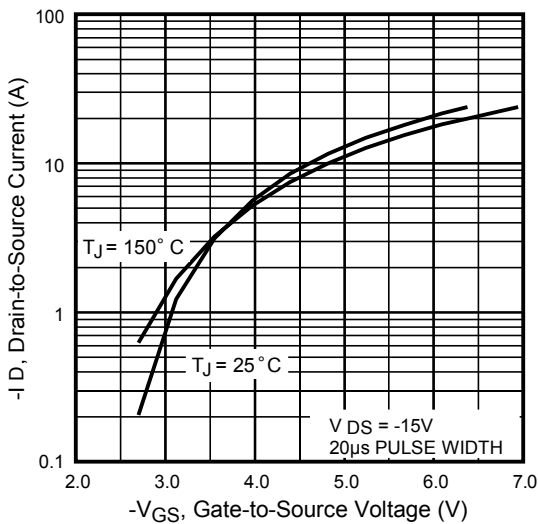

Fig 3. Typical Transfer Characteristics

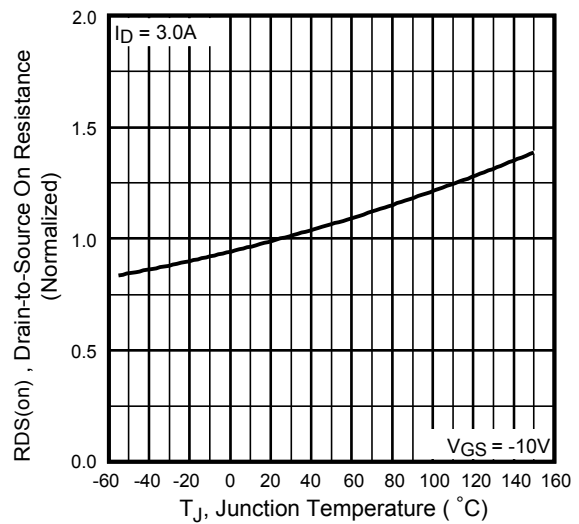

Fig 4. Normalized On-Resistance Vs. Temperature

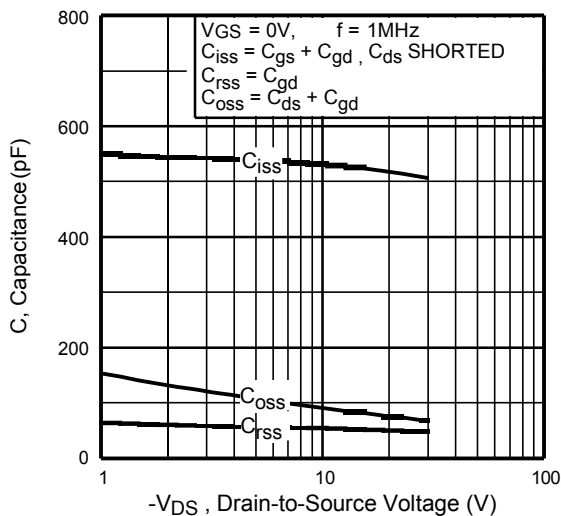

Fig 5. Typical Capacitance Vs. Drain-to-Source Voltage

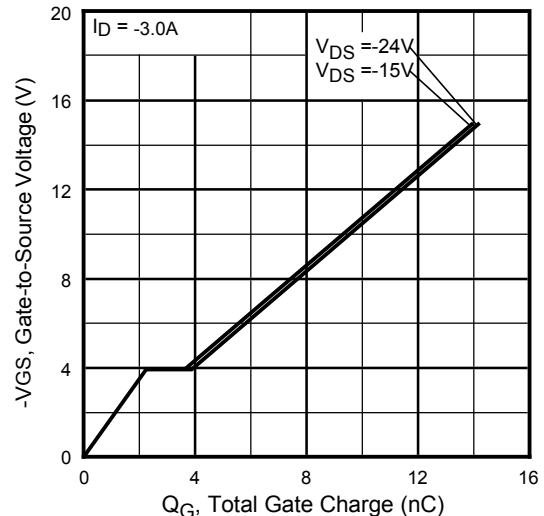

Fig 6. Typical Gate Charge Vs. Gate-to-Source Voltage

P-Channel Power MOSFET

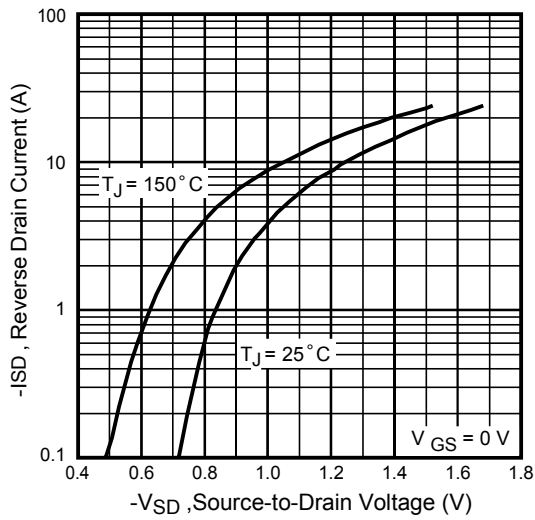

Fig 7. Typical Source-Drain Diode Forward Voltage

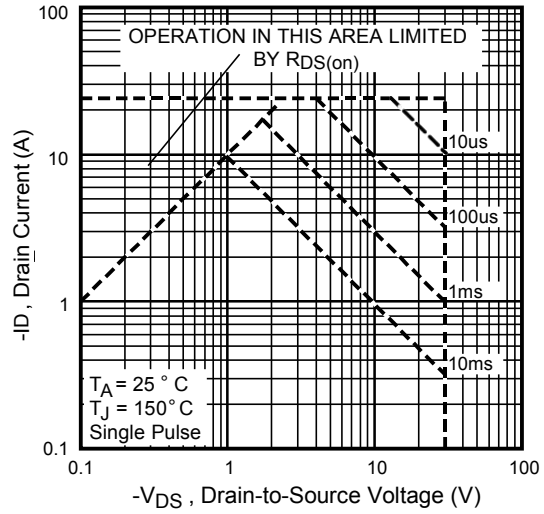

Fig 8. Maximum Safe Operating Area

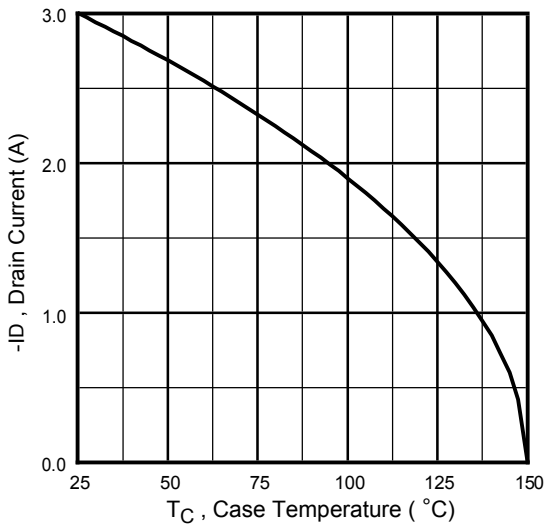

Fig 9. Maximum Drain Current Vs. Case Temperature

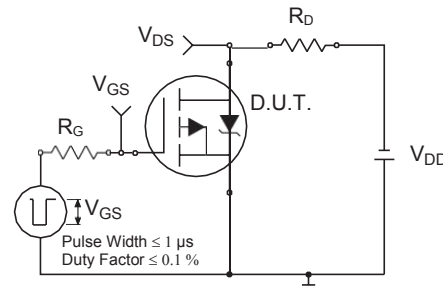

Fig 10a. Switching Time Test Circuit

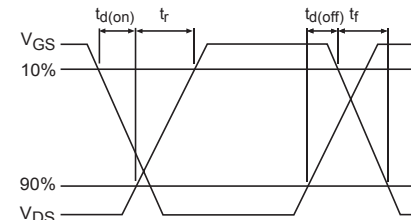

Fig 10b. Switching Time Waveforms

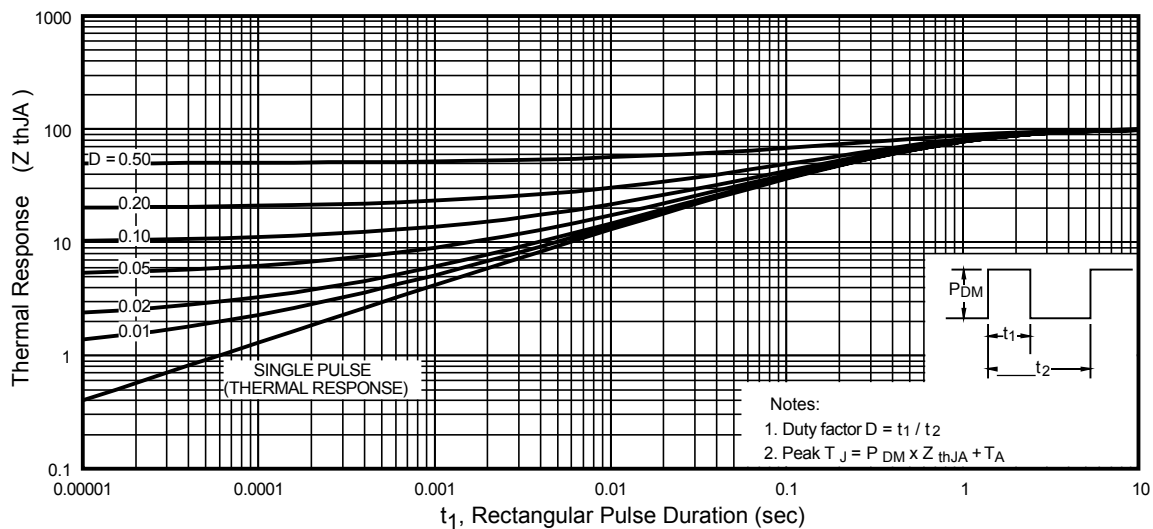

Fig 11. Maximum Effective Transient Thermal Impedance, Junction-to-Ambient

P-Channel Power MOSFET

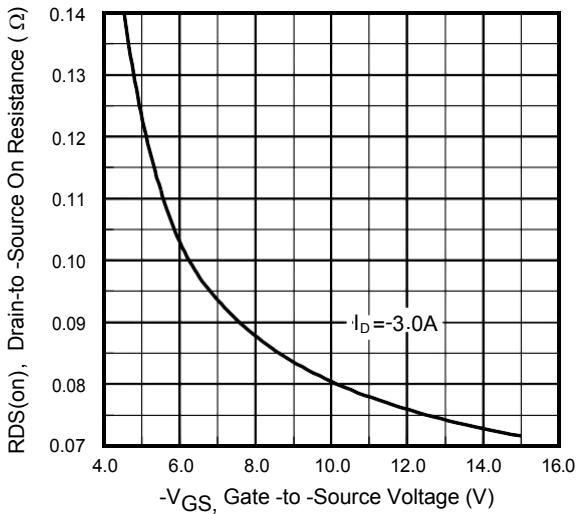

Fig 11. Typical On-Resistance Vs. Gate Voltage

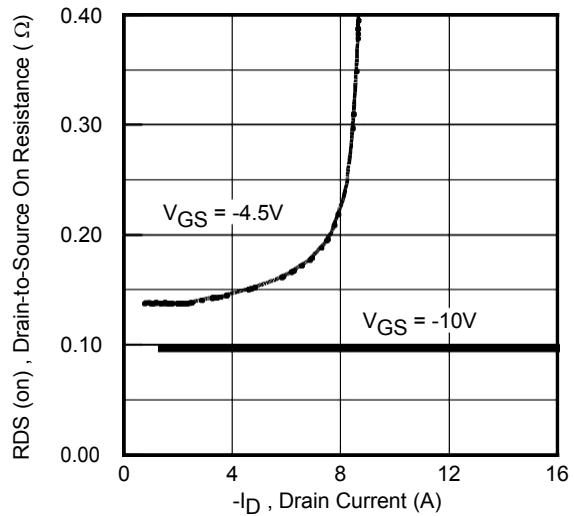

Fig 12. Typical On-Resistance Vs. Drain Current

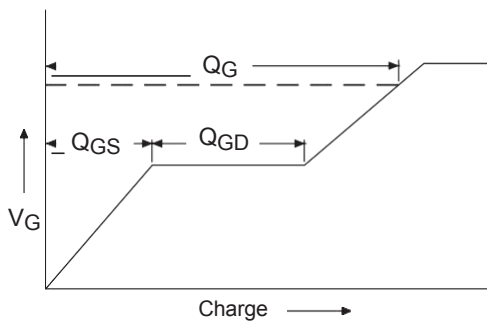

Fig 13a. Basic Gate Charge Waveform

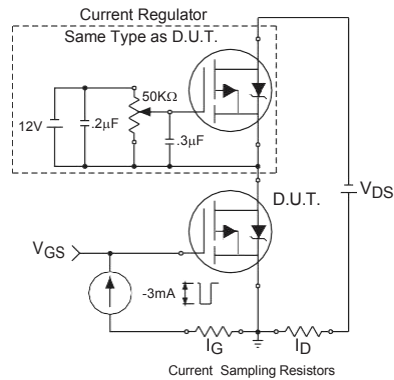

Fig 13b. Gate Charge Test Circuit

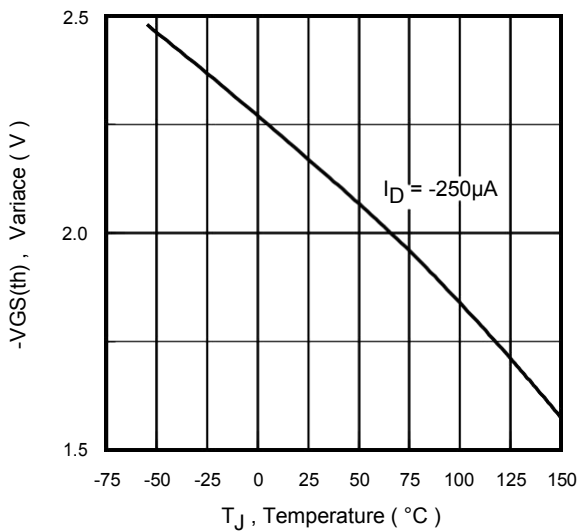

Fig 14. Threshold Voltage Vs. Temperature

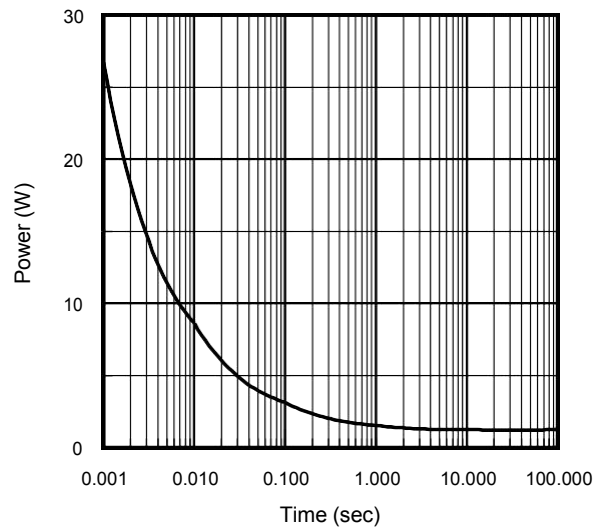
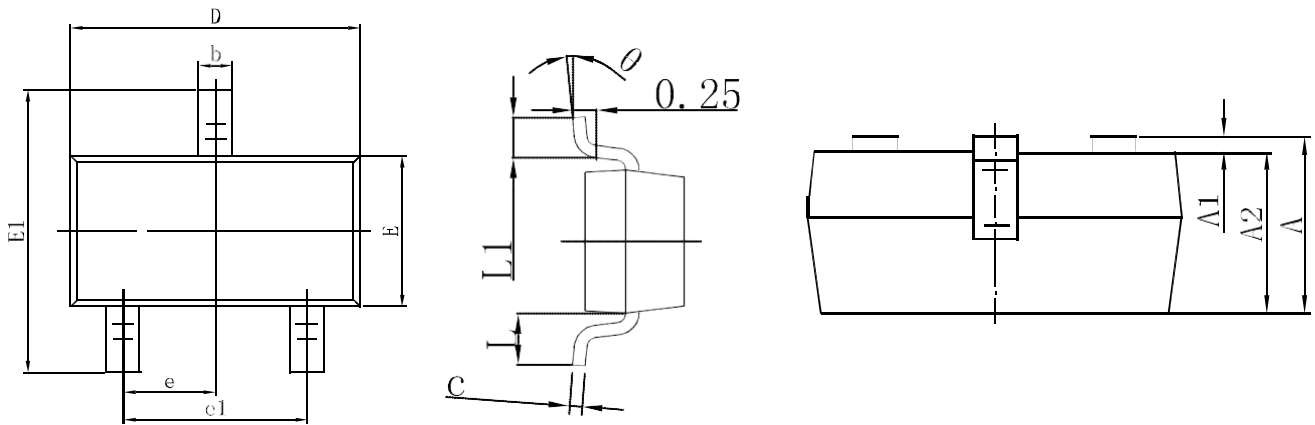

Fig 15. Typical Power Vs. Time

SOT-23 Package Outline Dimensions



Symbol	Dimensions In Millimeters		Dimensions In Inches	
	Min.	Max.	Min.	Max.
A	0.900	1.150	0.035	0.045
A1	0.000	0.100	0.000	0.004
A2	0.900	1.050	0.035	0.041
b	0.300	0.500	0.012	0.020
c	0.080	0.150	0.003	0.006
D	2.800	3.000	0.110	0.118
E	1.200	1.400	0.047	0.055
E1	2.250	2.550	0.089	0.100
e	0.950 TYP		0.037 TYP	
e1	1.800	2.000	0.071	0.079
L	0.550 REF		0.022 REF	
L1	0.300	0.500	0.012	0.020
θ	0°	8°	0°	8°

SOT-23 Suggested Pad Layout

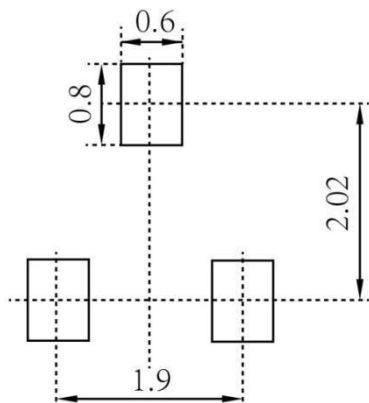

Note:

1. Controlling dimension: in millimeters
2. General tolerance: ±0.05mm
3. The pad layout is for reference purposes only

SOT-23 Tape and Reel

SOT-23 Embossed Carrier Tape

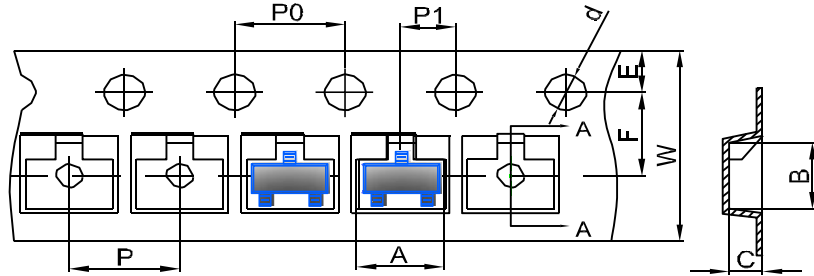

DIMENSIONS ARE IN MILLIMETER										
TYPE	A	B	C	d	E	F	P0	P	P1	W
SOT-23	3.15	2.77	1.22	Ø1.50	1.75	3.50	4.00	4.00	2.00	8.00
TOLERANCE	±0.1	±0.1	±0.1	±0.1	±0.1	±0.1	±0.1	±0.1	±0.1	±0.1

SOT-23 Tape Leader and Trailer

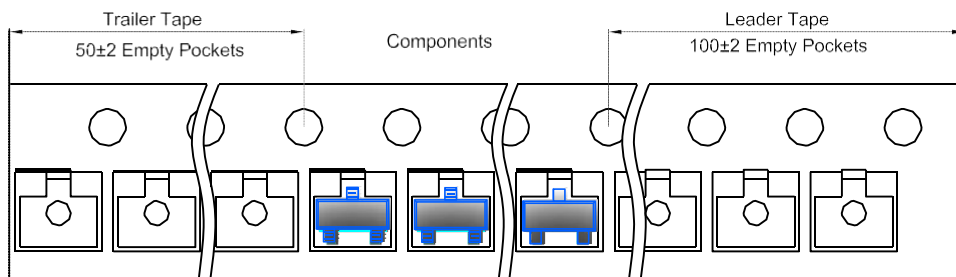

SOT-23 Reel

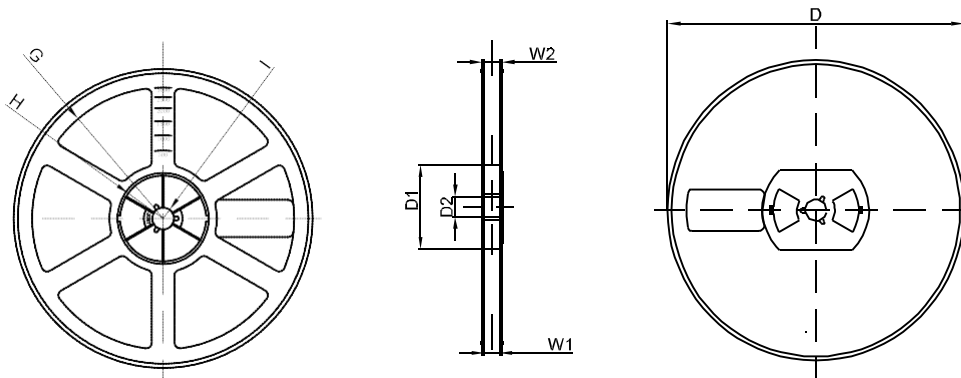

DIMENSIONS ARE IN MILLIMETER								
REEL OPTION	D	D1	D2	G	H	I	W1	W2
7" DIA	Ø178	54.40	13.00	R78	R25.60	R6.50	9.50	12.30
TOLERANCE	±2	±1	±1	±1	±1	±1	±1	±1

X-ON Electronics

Largest Supplier of Electrical and Electronic Components

Click to view similar products for [MOSFET](#) category:

Click to view products by [Hottech](#) manufacturer:

Other Similar products are found below :

[IRFD120](#) [JANTX2N5237](#) [2SK2267\(Q\)](#) [BUK455-60A/B](#) [TK100A10N1,S4X\(S](#) [MIC4420CM-TR](#) [VN1206L](#) [NDP4060](#) [SI4482DY](#)
[IRS2092STRPBF-EL](#) [IPS70R2K0CEAKMA1](#) [SQM120N06-3M5L-GE3](#) [TK31J60W5,S1VQ\(O](#) [TK31J60W,S1VQ\(O](#) [TK16J60W,S1VQ\(O](#)
[2SK2614\(TE16L1,Q\)](#) [DMN1017UCP3-7](#) [EFC2J004NUZTDG](#) [P85W28HP2F-7071](#) [NTE2384](#) [DMC2700UDMQ-7](#) [DMN2080UCB4-7](#)
[DMN61D9UWQ-13](#) [US6M2GTR](#) [DMN31D5UDJ-7](#) [DMP22D4UFO-7B](#) [IPS60R3K4CEAKMA1](#) [DMN1006UCA6-7](#) [DMN16M9UCA6-7](#)
[STF5N65M6](#) [IRF40H233XTMA1](#) [STU5N65M6](#) [DMN6022SSD-13](#) [DMN13M9UCA6-7](#) [DMTH10H4M6SPS-13](#) [IPS60R360PFD7SAKMA1](#)
[DMN2990UFB-7B](#) [SSM3K35CT,L3F](#) [IPLK60R1K0PFD7ATMA1](#) [2N7002W-G](#) [MCAC30N06Y-TP](#) [IPWS65R035CFD7AXKSA1](#)
[MCQ7328-TP](#) [SSM3J143TU,LXHF](#) [DMN12M3UCA6-7](#) [PJMF280N65E1_T0_00201](#) [PJMF380N65E1_T0_00201](#)
[PJMF280N60E1_T0_00201](#) [PJMF600N65E1_T0_00201](#) [PJMF900N65E1_T0_00201](#)