

1.0 AMP. Surface Mount Rectifiers

M1---M7

FEATURES

- For surface mounted application
- Low forward voltage drop
- High current capability
- Easy pick and place
- High surge current capability
- Plastic material used carries Underwriters
- Laboratory Classification 94V-0 260°C / 10 seconds at terminals

MECHANICAL DATA

- Case: Molded plastic DO-214AC
- Terminals: Pure tin plated, lead free solderable per J-STD-002B and JESD22-B102D.
- Polarity: Indicated by cathode band
- Packaging: 12mm tapeper EIA STD RS-481
- Weight: 0.064 gram

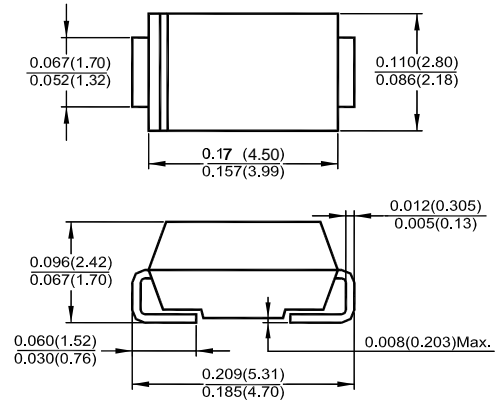

Dimensions in inches and (millimeters)
DO-214AC (SMA)

MAXIMUM RATINGS AND ELECTRICAL CHARACTERISTICS

Ratings at 25 °C ambient temperature unless otherwise specified. Single phase, half wave, 60 Hz, resistive or inductive load. For capacitive load, derate current by 20%.

Parameter	Symbols	M1	M2	M3	M4	M5	M6	M7	Unit
Maximum Repetitive Peak Reverse Voltage	VRRM	50	100	200	400	600	800	1000	V
Maximum RMS Voltage	VRMS	35	70	140	280	420	560	700	V
Maximum DC Blocking Voltage	VDC	50	100	200	400	600	800	1000	V
Maximum Average Forward Rectified Current at $T_L = 100^\circ\text{C}$	I(A)	1							A
Peak Forward Surge Current 8.3ms Single Half Sine-wave Superimposed on Rated Load (JEDEC)	IFSM	30							A
Maximum Instantaneous Forward Voltage at 1 A	VF	1.1							V
Maximum DC Reverse Current $T_A = 25^\circ\text{C}$ at Rated DC Blocking Voltage $T_A = 125^\circ\text{C}$	IR	5 200							μA
Typical Junction Capacitance ¹⁾	CJ	15							pF
Maximum Thermal Resistance ²⁾	R JL	30							$^\circ\text{C}/\text{W}$
Operating and Storage Temperature Range	TJ, TS	- 50 to + 150							$^\circ\text{C}$

1) Measured at 1MHz and applied reverse voltage of 4 V
2) 8 mm² (0.013 mm thick) land areas

M1---M7 Typical Characteristics

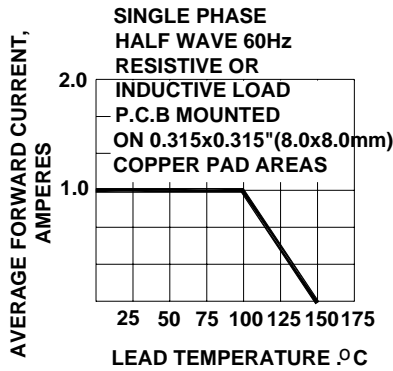

Fig. 1-FORWARD CURRENT DERATING CURVE

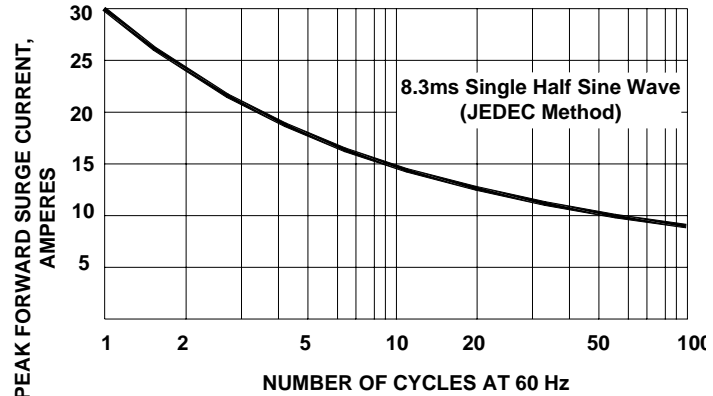

Fig. 2-MAXIMUM NON-REPETITIVE PEAK FORWARD SURGE CURRENT

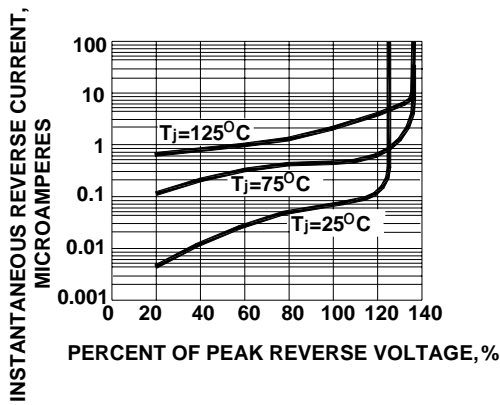

Fig. 3-TYPICAL REVERSE CHARACTERISTICS

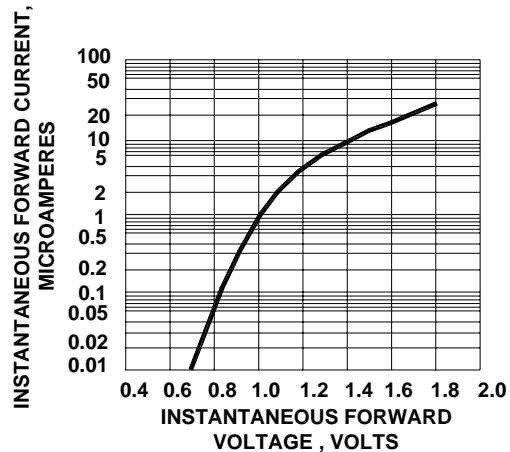

Fig. 4-TYPICAL INSTANTANEOUS FORWARD CHARACTERISTICS

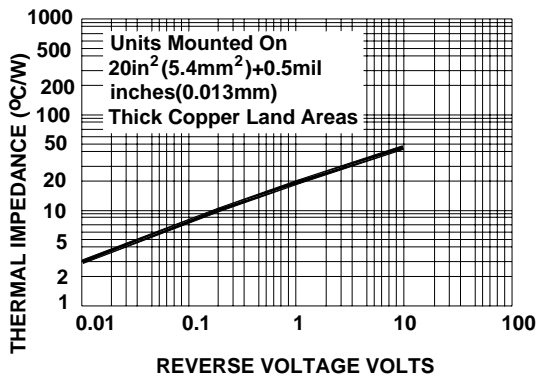

Fig. 5-TRANSIENT THERMAL IMPEDANCE

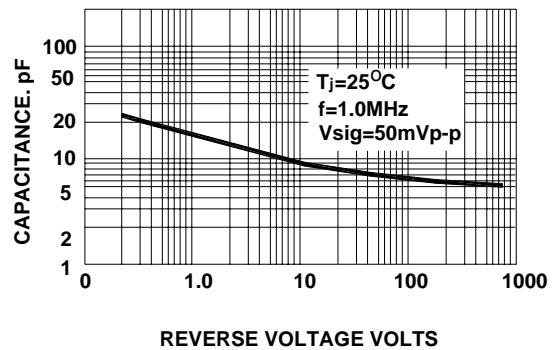

Fig. 6-TYPICAL JUNCTION CAPACITANCE

X-ON Electronics

Largest Supplier of Electrical and Electronic Components

Click to view similar products for [Diodes - General Purpose, Power, Switching category](#):

Click to view products by [Hottech manufacturer](#):

Other Similar products are found below :

[MCL4151-TR3](#) [MMBD3004S-13-F](#) [RD0306T-H](#) [RD0506LS-SB-1H](#) [RGP30G-E373](#) [DSE010-TR-E](#) [BAQ333-TR](#) [BAQ335-TR](#) [BAQ33-GS18](#) [BAS1602VH6327XT](#) [BAV17-TR](#) [BAV19-TR](#) [BAV301-TR](#) [BAW27-TAP](#) [HSC285TRF-E](#) [NSVBAV23CLT1G](#) [NTE525](#) [1SS181-TP](#) [1SS184-TP](#) [1SS193,LF](#) [1SS193-TP](#) [1SS400CST2RA](#) [SBAV99LT3G](#) [SDAA13](#) [LL4448-GS18](#) [SHN2D02FUTW1T1G](#) [LS4150GS18](#) [LS4151GS08](#) [SMMD7000LT3G](#) [FC903-TR-E](#) [1N4449](#) [1N4934-E3/73](#) [1SS226-TP](#) [APT100DL60HJ](#) [RFUH20TB3S](#) [RGP30G-E354](#) [RGP30M-E3/73](#) [D291S45T](#) [MCL4151-TR](#) [BAS 16-02V H6327](#) [BAS 21U E6327](#) [BAS 28 E6327](#) [BAS33-TAP](#) [BAS 70-02V H6327](#) [BAV300-TR](#) [BAV303-TR3](#) [BAW27-TR](#) [BAW56DWQ-7-F](#) [BAW56M3T5G](#) [BAW75-TAP](#)