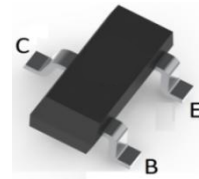
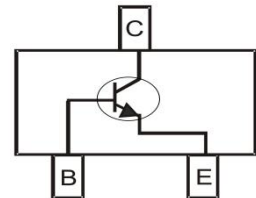

**BIPOLAR TRANSISTOR (NPN)**
**FEATURES**

- Complementary to MMBT4403
- Switching Transistor
- Surface Mount device

**SOT-23**
**MECHANICAL DATA**

- Case: SOT-23
- Case Material: Molded Plastic. UL flammability
- Classification Rating: 94V-0
- Weight: 0.008 grams (approximate)

**MAXIMUM RATINGS (T<sub>A</sub> = 25°C unless otherwise noted)**

Parameter	Symbol	Value	Unit
Collector-Base Voltage	V <sub>CB0</sub>	60	V
Collector-Emitter Voltage	V <sub>CEO</sub>	40	V
Emitter-Base Voltage	V <sub>EBO</sub>	6	V
Collector Current	I <sub>C</sub>	600	mA
Collector Power Dissipation	P <sub>C</sub>	300	mW
Thermal Resistance From Junction To Ambient	R <sub>θJA</sub>	417	°C/W
Junction Temperature	T <sub>J</sub>	150	°C
Storage Temperature	T <sub>STG</sub>	-55 ~+150	°C

**ELECTRICAL CHARACTERISTICS (T<sub>A</sub> = 25°C unless otherwise specified)**

Parameter	Symbol	Min	Typ	Max	Unit	Conditions
Collector-base breakdown voltage	V <sub>(BR)CBO</sub>	60			V	I <sub>C</sub> =100uA, I <sub>E</sub> =0
Collector-emitter breakdown voltage	V <sub>(BR)CEO</sub>	40			V	I <sub>C</sub> =1mA, I <sub>B</sub> =0
Emitter-base breakdown voltage	V <sub>(BR)EBO</sub>	6			V	I <sub>E</sub> =100uA, I <sub>C</sub> =0
Collector cut-off current	I <sub>CBO</sub>			0.1	uA	V <sub>CB</sub> =50V, I <sub>E</sub> =0
Collector cut-off current	I <sub>CEX</sub>			0.1	uA	V <sub>CE</sub> =35V, V <sub>BE</sub> =0.4V
Emitter cut-off current	I <sub>EBO</sub>			0.1	uA	V <sub>EB</sub> =5V, I <sub>C</sub> =0
DC current gain	h <sub>FE1</sub>	20				V <sub>CE</sub> =1V, I <sub>C</sub> =0.1mA
	h <sub>FE2</sub>	40				V <sub>CE</sub> =1V, I <sub>C</sub> =1mA
	h <sub>FE3</sub>	80				V <sub>CE</sub> =1V, I <sub>C</sub> =10mA
	h <sub>FE4</sub>	100		300		V <sub>CE</sub> =1V, I <sub>C</sub> =150mA
	h <sub>FE5</sub>	40				V <sub>CE</sub> =2V, I <sub>C</sub> =500mA
Collector-emitter saturation voltage	V <sub>CE(sat)</sub>			0.4	V	I <sub>C</sub> =150mA, I <sub>B</sub> =15mA
	V <sub>CE(sat)</sub>			0.75	V	I <sub>C</sub> =500mA, I <sub>B</sub> =50mA
Base-emitter saturation voltage	V <sub>BE(sat)</sub>			0.95	V	I <sub>C</sub> =150mA, I <sub>B</sub> =15mA
	V <sub>BE(sat)</sub>			1.2	V	I <sub>C</sub> =500mA, I <sub>B</sub> =50mA
Transition frequency	f <sub>T</sub>	250			MHz	V <sub>CE</sub> =10V, I <sub>C</sub> =20mA, f=100MHz
Delay time	t <sub>d</sub>			15	ns	V <sub>CC</sub> =30V, V <sub>BE(OFF)</sub> =2V,
Rise time	t <sub>r</sub>			20	ns	I <sub>C</sub> =150mA, I <sub>B1</sub> =15mA
Storage time	t <sub>s</sub>			225	ns	V <sub>CC</sub> =30V, I <sub>C</sub> =150mA
Fall time	t <sub>f</sub>			60	ns	I <sub>B1</sub> =I <sub>B2</sub> =15mA

**CLASSIFICATION OF h<sub>FE</sub>**

Range	100-300
Marking	2X

**BIPOLAR TRANSISTOR (NPN)**

**Typical Characteristics**

**Static Characteristic**

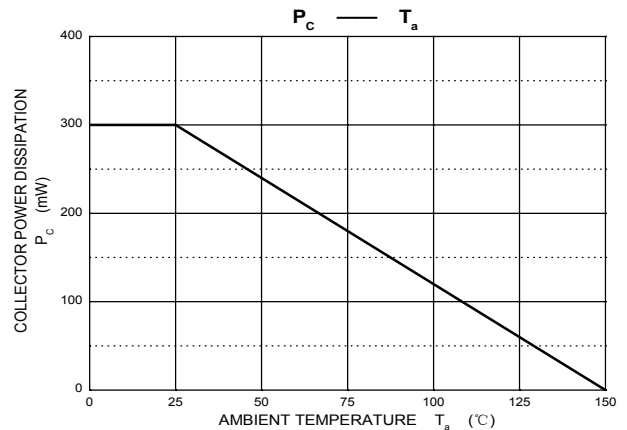
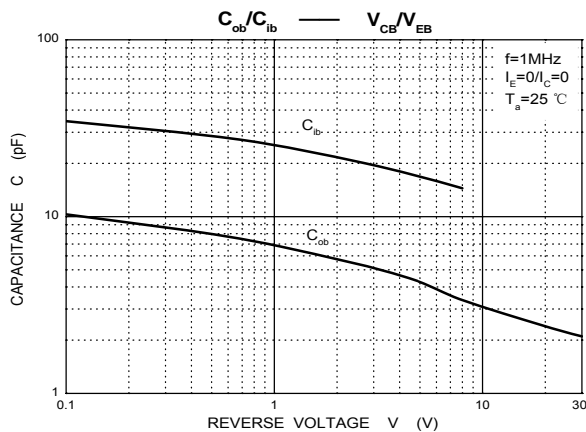
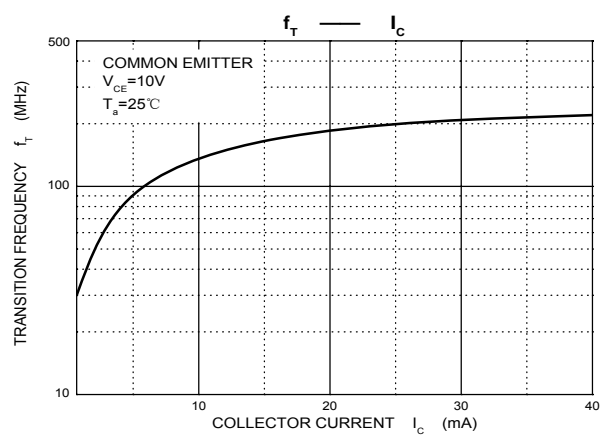
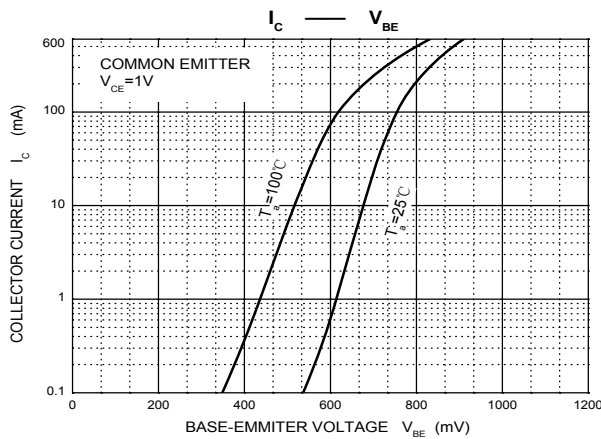
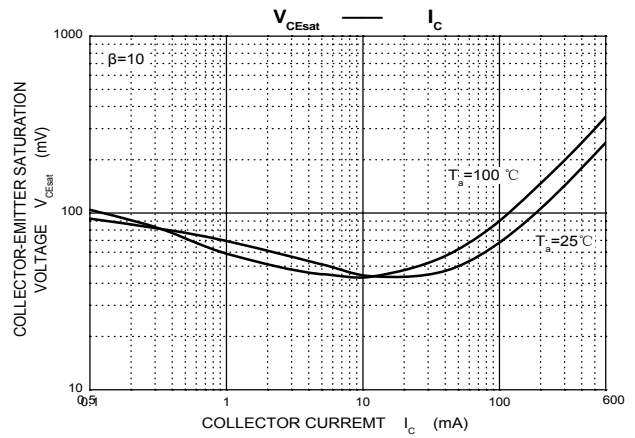
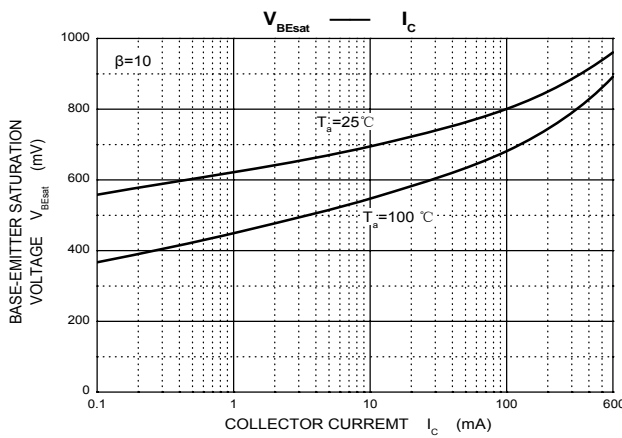
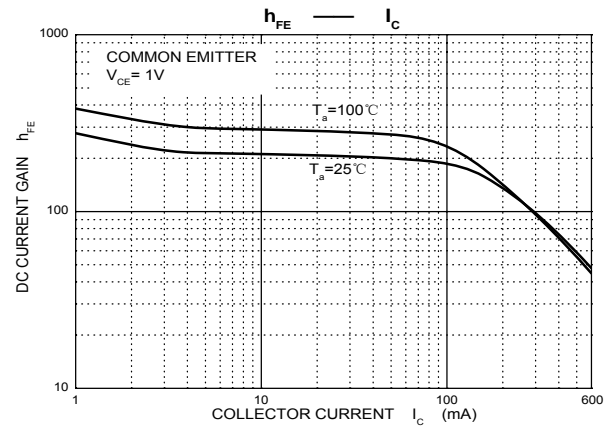
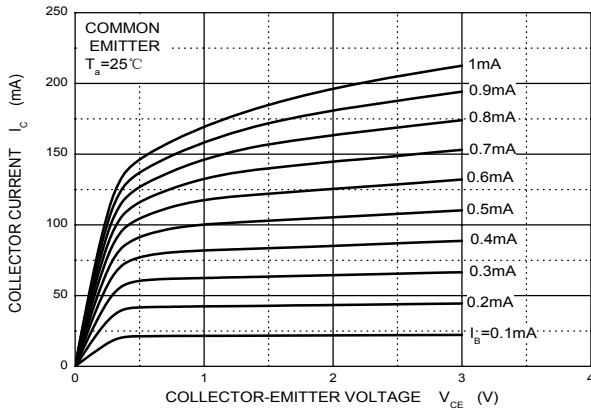

**BIPOLAR TRANSISTOR (NPN)**

**SOT-23 Package Outline Dimensions**



Symbol	Dimensions In Millimeters		Dimensions In Inches	
	Min.	Max.	Min.	Max.
A	0.900	1.150	0.035	0.045
A1	0.000	0.100	0.000	0.004
A2	0.900	1.050	0.035	0.041
b	0.300	0.500	0.012	0.020
c	0.080	0.150	0.003	0.006
D	2.800	3.000	0.110	0.118
E	1.200	1.400	0.047	0.055
E1	2.250	2.550	0.089	0.100
e	0.950 TYP		0.037 TYP	
e1	1.800	2.000	0.071	0.079
L	0.550 REF		0.022 REF	
L1	0.300	0.500	0.012	0.020
θ	0°	8°	0°	8°

**SOT-23 Suggested Pad Layout**

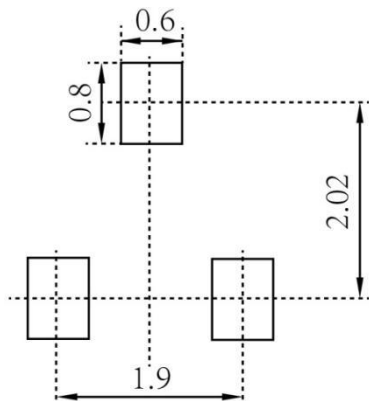

**Note:**

1. Controlling dimension: in millimeters
2. General tolerance:  $\pm 0.05\text{mm}$
3. The pad layout is for reference purposes only

**BIPOLAR TRANSISTOR (NPN)**

**SOT-23 Tape and Reel**

**SOT-23 Embossed Carrier Tape**



DIMENSIONS ARE IN MILLIMETER										
TYPE	A	B	C	d	E	F	P0	P	P1	W
SOT-23	3.15	2.77	1.22	Ø1.50	1.75	3.50	4.00	4.00	2.00	8.00
TOLERANCE	±0.1	±0.1	±0.1	±0.1	±0.1	±0.1	±0.1	±0.1	±0.1	±0.1

**SOT-23 Tape Leader and Trailer**



**SOT-23 Reel**

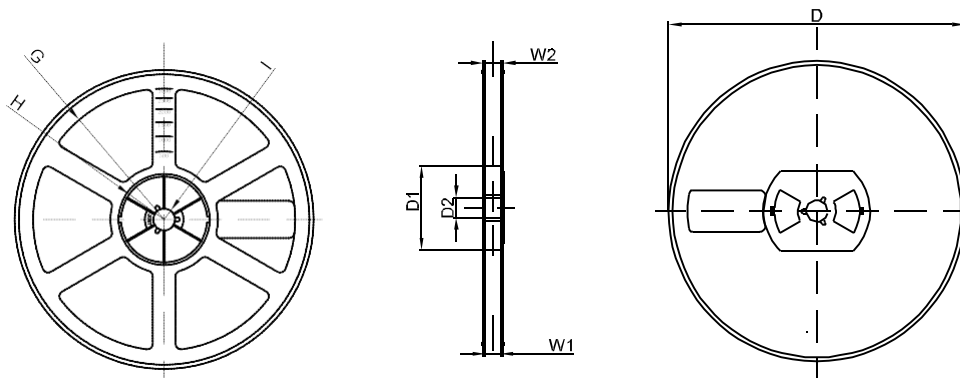

DIMENSIONS ARE IN MILLIMETER								
REEL OPTION	D	D1	D2	G	H	I	W1	W2
7" DIA	Ø178	54.40	13.00	R78	R25.60	R6.50	9.50	12.30
TOLERANCE	±2	±1	±1	±1	±1	±1	±1	±1

## X-ON Electronics

Largest Supplier of Electrical and Electronic Components

*Click to view similar products for [Bipolar Transistors - BJT category](#):*

*Click to view products by [Hottech manufacturer](#):*

Other Similar products are found below :

[619691C](#) [MCH4017-TL-H](#) [MMBT-2369-TR](#) [BC546/116](#) [BC557/116](#) [BSW67A](#) [NJVMJD148T4G](#) [NTE123AP-10](#) [NTE153MCP](#) [NTE16](#)  
[NTE195A](#) [NTE92](#) [C4460](#) [2N4401-A](#) [2N6728](#) [2SA1419T-TD-H](#) [2SA2126-E](#) [2SB1204S-TL-E](#) [2SC2712S-GR,LF](#) [2SC5488A-TL-H](#)  
[2SD2150T100R](#) [SP000011176](#) [2N2907A](#) [2N3904-NS](#) [2N5769](#) [2SC2412KT146S](#) [2SD1816S-TL-E](#) [CPH6501-TL-E](#) [MCH4021-TL-E](#)  
[MJE340](#) [US6T6TR](#) [NJL0281DG](#) [732314D](#) [CPH3121-TL-E](#) [CPH6021-TL-H](#) [873787E](#) [IMZ2AT108](#) [UMX21NTR](#) [MCH6102-TL-E](#)  
[NJL0302DG](#) [2N3583](#) [30A02MH-TL-E](#) [NSV40301MZ4T1G](#) [NTE13](#) [NTE26](#) [NTE282](#) [NTE323](#) [NTE350](#) [NTE81](#) [STX83003-AP](#)