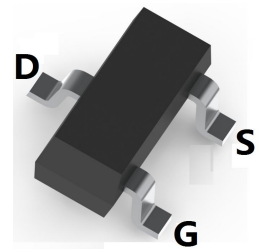
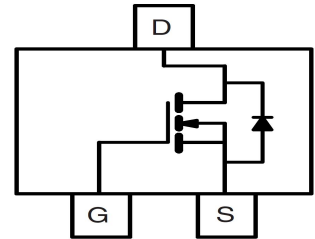

LOW VOLTAGE MOSFET (N-CHANNEL)
FEATURES

- Ultra Low on-resistance: $V_{DS}=20V, R_{DS(ON)} \leq 31.8m\Omega @ V_{GS}=4.5V, I_D=5A$
- For Low power DC to DC converter application
- For Load switch application
- Surface Mount device

SOT-23

MECHANICAL DATA

- Case: SOT-23
- Case Material: Molded Plastic. UL flammability
- Classification Rating: 94V-0
- Weight: 0.008 grams (approximate)

MAXIMUM RATINGS ($T_A = 25^\circ\text{C}$ unless otherwise noted)

Parameter	Symbol	Value	Unit
Drain-source voltage	V_{DS}	20	V
Gate-source voltage	V_{GS}	± 8	V
Continuous drain current	I_D	5	A
Pulsed drain current (Note 1)	I_{DM}	20	A
Continuous Source-Drain Diode current	I_S	1.04	A
Power dissipation	P_D	0.35	W
Thermal resistance from Junction to ambient	$R_{\theta JA}$	357	$^\circ\text{C/W}$
Junction temperature	T_J	150	$^\circ\text{C}$
Storage temperature	T_{STG}	-55 ~ +150	$^\circ\text{C}$

ELECTRICAL CHARACTERISTICS ($T_A = 25^\circ\text{C}$ unless otherwise specified)

Parameter	Symbol	Min	Typ	Max	Unit	Conditions
Drain-Source breakdown voltage	$V_{(BR)DSS}$	20			V	$V_{GS}=0V, I_D=250\mu A$
Zero gate voltage drain current	I_{DSS}			1	μA	$V_{DS}=20V, V_{GS}=0V$
Gate-body leakage current	I_{GSS}			± 100	nA	$V_{DS}=0V, V_{GS}=\pm 8V$
Gate-threshold voltage (note 1)	$V_{GS(th)}$	0.45	0.7	1.0	V	$V_{DS}=V_{GS}, I_D=250\mu A$
Drain-source on-resistance (note 1)	$R_{DS(ON)}$		18	31.8	$m\Omega$	$V_{GS}=4.5V, I_D=5A$
			23	35.6	$m\Omega$	$V_{GS}=2.5V, I_D=4.7A$
			30	41.4	$m\Omega$	$V_{GS}=1.8V, I_D=4.3A$
Forward transconductance (note 1)	g_{FS}		6		S	$V_{DS}=10V, I_D=5A$
Gate resistance	R_g	0.5		4.8	Ω	$f=1MHz$
Input capacitance	C_{iss}		865		pF	$V_{DS}=10V, V_{GS}=0V, f=1MHz$
Output capacitance	C_{oss}		105		pF	
Reverse transfer capacitance	C_{rss}		55		pF	
Turn-on delay time	$t_{d(on)}$			10	nS	$V_{DD}=30V, V_{GS}=10V, R_{GEN}=1\Omega, I_D=1.5A$
Turn-on rise time	t_r			20	nS	
Turn-off delay time	$t_{d(off)}$			32	nS	
Turn-off fall time	t_f			12	nS	
Diode forward voltage (note 1)	V_{SD}		0.75	1.2	V	$I_S=4A, V_{GS}=0V$

Note: 1. Pulse test: Pulse width $\leq 300\mu s$, Duty cycle $\leq 2\%$.

LOW VOLTAGE MOSFET (N-CHANNEL)

Typical Characteristics

Output Characteristics

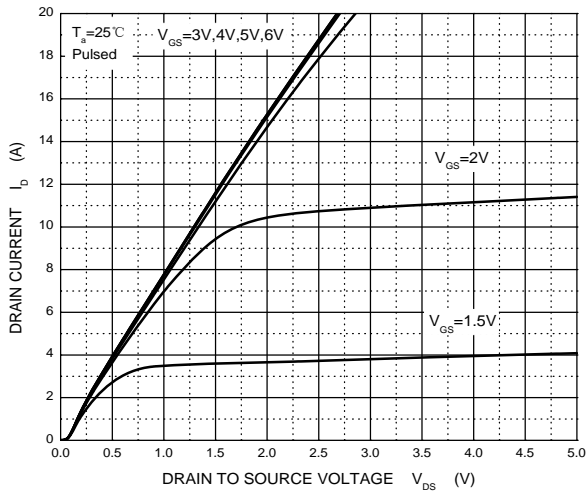

Transfer Characteristics

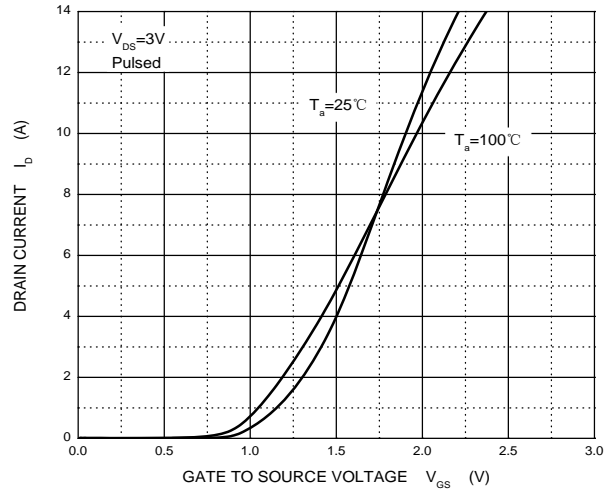

$R_{DS(ON)}$ — I_D

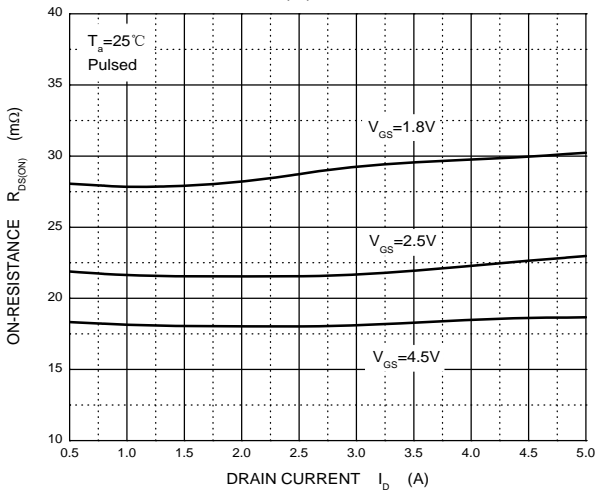

$R_{DS(ON)}$ — V_{GS}

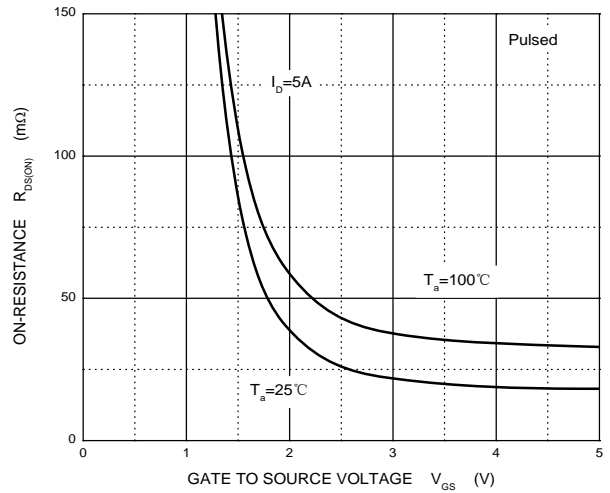

I_S — V_{SD}

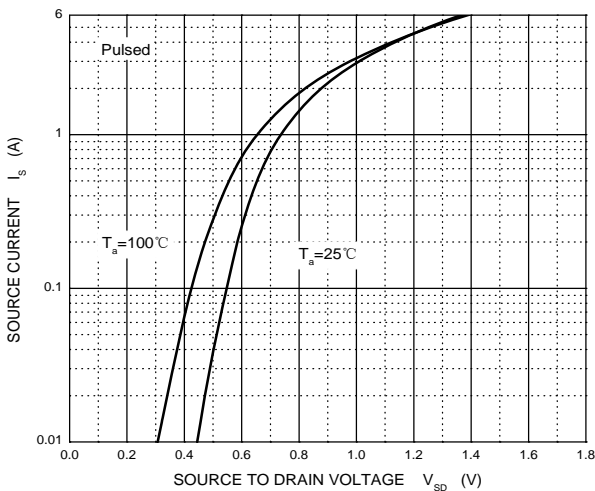

Threshold Voltage

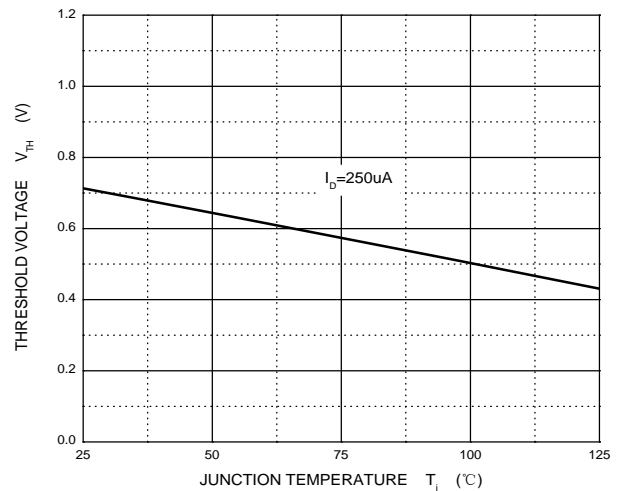

LOW VOLTAGE MOSFET (N-CHANNEL)

SOT-23 Package Outline Dimensions



Symbol	Dimensions In Millimeters		Dimensions In Inches	
	Min.	Max.	Min.	Max.
A	0.900	1.150	0.035	0.045
A1	0.000	0.100	0.000	0.004
A2	0.900	1.050	0.035	0.041
b	0.300	0.500	0.012	0.020
c	0.080	0.150	0.003	0.006
D	2.800	3.000	0.110	0.118
E	1.200	1.400	0.047	0.055
E1	2.250	2.550	0.089	0.100
e	0.950 TYP		0.037 TYP	
e1	1.800	2.000	0.071	0.079
L	0.550 REF		0.022 REF	
L1	0.300	0.500	0.012	0.020
θ	0°	8°	0°	8°

SOT-23 Suggested Pad Layout



Note:

1. Controlling dimension: in millimeters
2. General tolerance: $\pm 0.05\text{mm}$
3. The pad layout is for reference purposes only

LOW VOLTAGE MOSFET (N-CHANNEL)

SOT-23 Tape and Reel

SOT-23 Embossed Carrier Tape

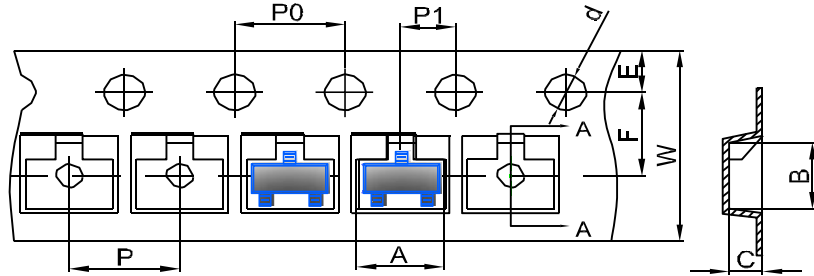

DIMENSIONS ARE IN MILLIMETER										
TYPE	A	B	C	d	E	F	P0	P	P1	W
SOT-23	3.15	2.77	1.22	Ø1.50	1.75	3.50	4.00	4.00	2.00	8.00
TOLERANCE	±0.1	±0.1	±0.1	±0.1	±0.1	±0.1	±0.1	±0.1	±0.1	±0.1

SOT-23 Tape Leader and Trailer

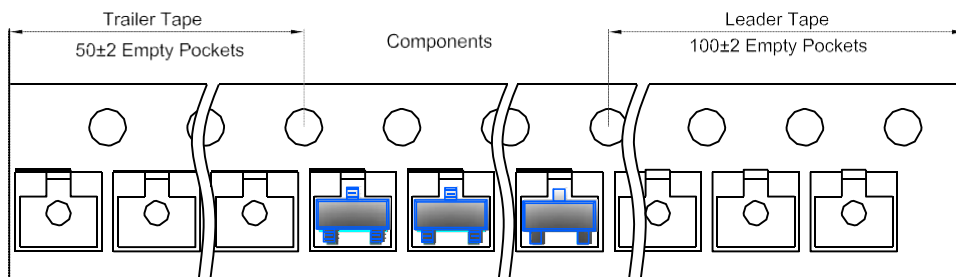

SOT-23 Reel

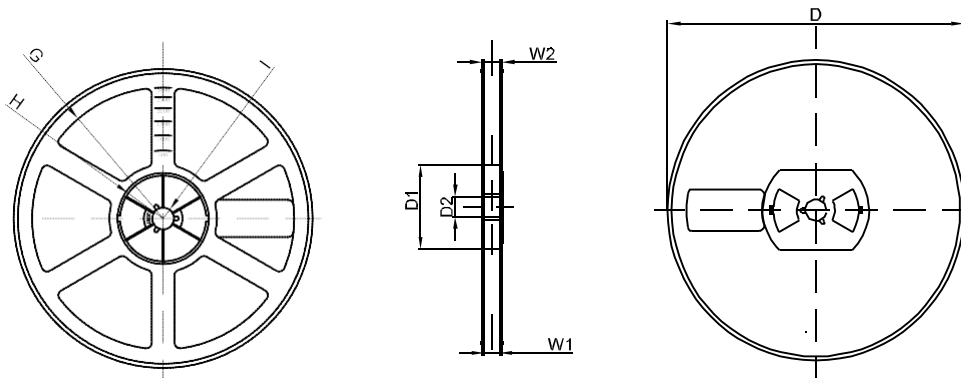

DIMENSIONS ARE IN MILLIMETER								
REEL OPTION	D	D1	D2	G	H	I	W1	W2
7" DIA	Ø178	54.40	13.00	R78	R25.60	R6.50	9.50	12.30
TOLERANCE	±2	±1	±1	±1	±1	±1	±1	±1

X-ON Electronics

Largest Supplier of Electrical and Electronic Components

Click to view similar products for [MOSFET](#) category:

Click to view products by [Hottech](#) manufacturer:

Other Similar products are found below :

[IRFD120](#) [JANTX2N5237](#) [2SK2267\(Q\)](#) [BUK455-60A/B](#) [TK100A10N1,S4X\(S](#) [MIC4420CM-TR](#) [VN1206L](#) [NDP4060](#) [SI4482DY](#)
[IRS2092STRPBF-EL](#) [IPS70R2K0CEAKMA1](#) [SQM120N06-3M5L-GE3](#) [TK31J60W5,S1VQ\(O](#) [TK31J60W,S1VQ\(O](#) [TK16J60W,S1VQ\(O](#)
[2SK2614\(TE16L1,Q\)](#) [DMN1017UCP3-7](#) [EFC2J004NUZTDG](#) [P85W28HP2F-7071](#) [NTE2384](#) [DMC2700UDMQ-7](#) [DMN2080UCB4-7](#)
[DMN61D9UWQ-13](#) [US6M2GTR](#) [DMN31D5UDJ-7](#) [DMP22D4UFO-7B](#) [IPS60R3K4CEAKMA1](#) [DMN1006UCA6-7](#) [DMN16M9UCA6-7](#)
[STF5N65M6](#) [IRF40H233XTMA1](#) [STU5N65M6](#) [DMN6022SSD-13](#) [DMN13M9UCA6-7](#) [DMTH10H4M6SPS-13](#) [IPS60R360PFD7SAKMA1](#)
[DMN2990UFB-7B](#) [SSM3K35CT,L3F](#) [IPLK60R1K0PFD7ATMA1](#) [2N7002W-G](#) [MCAC30N06Y-TP](#) [IPWS65R035CFD7AXKSA1](#)
[MCQ7328-TP](#) [SSM3J143TU,LXHF](#) [PJMF280N65E1_T0_00201](#) [PJMF380N65E1_T0_00201](#) [PJMF280N60E1_T0_00201](#)
[PJMF600N65E1_T0_00201](#) [PJMF900N65E1_T0_00201](#) [PJMF900N60E1_T0_00201](#)