

**Holy Ram**  
Electronic Technology

**HIRE**  
芯声



# MultiLayer Ceramic Chip Capacitors

贴片电容 中国新生



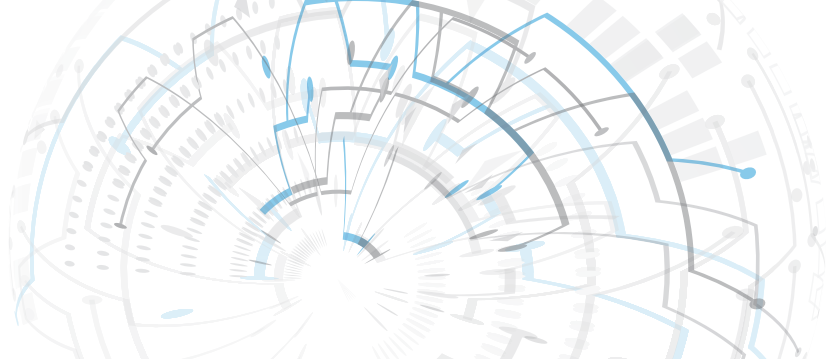

# 目录

# contents

---

叠层陶瓷电容说明 .....	1
产品型号命名规则 .....	2
可靠度等级描述 .....	3
一般常规电容标准.....	3
产品结构和尺寸.....	4
一般常规电容容值范围及电压.....	5
工业级-Level I .....	77
工业级-Level II.....	95
可靠性规格和测试条件.....	97
产品包装.....	101
运输与储存方法.....	104
使用注意事项.....	105



## 叠层陶瓷电容说明

### 一般常规电容

常规电容按照材质特性可分为温度补偿型(Class I 类)和高介电常数型 (Class II类) 两种。

温度补偿型：该类材质电容器对温度的稳定性高，在不同的电压、温度下的稳定性最佳，且其损失最少。

高介电常数型：此类介质材料的电容器具有较高的介电常数，容量相比温度补偿型电容器高，但其精度和稳定性较差。

### 工业级电容--Level I

工业级--Level I 电容 (MLCC) 是一种使用于工业应用的贴片电容。在一般常规电容 (MLCC) 性能的基础上，提高了产品的防潮性能和更高的可靠性。

### 工业级电容--Level II

工业级--Level II 电容 (MLCC) 是一种使用于工业应用的贴片电容。在工业级--Level I (MLCC) 性能的基础上，提高了产品的防潮性能和更高的可靠性。接近于车载电容的可靠性标准。

## 产品型号命名规则

<u>C</u>	<u>SA</u>	<u>0402</u>	<u>X7R</u>	<u>104</u>	<u>K</u>	<u>500</u>	<u>G</u>	<u>T</u>
①	②	③	④	⑤	⑥	⑦	⑧	⑨

### C: MLCC

#### 特殊应用

SA:一般品      IA:工业级-Level I      IB:工业级-Level II

#### 产品尺寸: EIA

01R5(0402)      0201(0603)      0402(1005)      0603(1608)      0805(2012)  
1206(3216)      1210(3225)

#### 电容温度特性

C0G    X7R    X5R    X6S

#### 电容容值

容值 $\geq 10\text{pF}$ 的表示方式  
First Two x 10third  
104 =  $10 \times 10^4 \text{pF} = 100\text{nF}$     123 =  $12 \times 10^3 \text{pF} = 12\text{nF}$   
容值 $< 10\text{pF}$ 的表示方式: 0R2 =  $0.2\text{pF}$

#### 容值误差值

A:  $\pm 0.05\text{pF}$     B:  $\pm 0.1\text{pF}$     C:  $\pm 0.25\text{pF}$     D:  $\pm 0.5\text{pF}$     F:  $\pm 1.0\%$   
G:  $\pm 2\%$     J:  $\pm 5\%$     K:  $\pm 10\%$     M:  $\pm 20\%$     Z: 80/-20%

#### 额定电压:(单位: V)

2R5: 2.5    4R0: 4    6R3: 6.3    100: 10    160: 16    250: 25    350: 35    500: 50  
630: 63    800: 80    101: 100    201: 200    251: 250    401: 400    451: 450    501: 500  
631: 630    102: 1000    202: 2000    302: 3000    402: 4000

#### 产品厚度 (单位: mm)

A: 0.125    B: 0.130    C: 0.180    D: 0.200    E: 0.300    F: 0.450    G: 0.500    H: 0.600  
J: 0.800    K: 0.850    L: 1.150    M: 1.250    N: 1.600    P: 1.900    Q: 2.000    R: 2.500

#### 包装方式

B= 散装/袋装  
T= 编带/卷装(默认7inch卷盘)  
S= 特殊包装

## 可靠度等级描述

### 技术要求

可靠度项目	一般常规品 (含中高压)	工业级品	车载品
高温高湿	40°C, 95%RH, 1Vr,500h	65°C, 90%RH, 1Vr,500h	85°C, 85%RH, 1.3~1.5Vr,1000h
高温加载	高温, 1.5Vr1000h	高温, 1.5Vr1000h	高温, 2.0Vr1000h
抗弯曲度	1mm	1mm	2mm
冷热冲击	5个循环	5个循环	1000个循环

1. 在耐久性和使用寿命试验中标有“降额”的部分小于额定电压的150%。
2. 部分部件适用于额定电压×150%或×120%。请参阅个别规格。
3. 部分零件有2mm弯曲保证。请参阅个别规格

## 一般常规电容标准

### 特性

常规电容按照材质特性可分为温度补偿型(Class I类)和高介电常数型(Class II类)两种。

温度补偿型:

该类材质电容器对温度的稳定性高,在不同的电压、温度下的稳定性最佳,且其损失最少。其温度系数为30 ppm/°C,适用于低损耗、稳定性要求高的电路中,如滤波器、谐振器和计时电路等,常见的有COG系列或NPO系列。

高介电常数型:

此类介质材料的电容器具有较高的介电常数,容量相比温度补偿型电容器高,但其精度和稳定性较差。在-55°C至85°C (125°C)的温度范围内,电容量误差值会在15%以内,适用于容量范围广的电路中,如隔直、耦合、旁路电路等,常见的有X5R, X7R, X6S等系列。

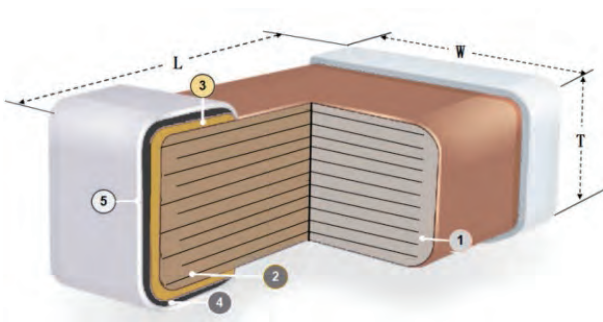

序号	名称
1	陶瓷介质
2	内电极
3	外电极
4	镍层
5	锡层

### 应用

家电, 三表, 照明, 黑电等。手机、电脑、基站、网通、工控、伺服等。  
汽车辅助系统、汽车动力安全系统、汽车电源系统等。

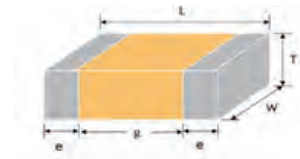

## 产品结构和尺寸

规格(EIA)	尺寸(mm)				代码
	L	W	e	T	
01005	0.40±0.02	0.20±0.02	0.07~0.13	0.20±0.02	D
0201	0.60±0.03	0.30±0.03	0.1~0.2	0.30±0.03	E
	0.60-0.03/ + 0.1	0.30-0.03/ + 0.1	0.1~0.25	0.30-0.03/ + 0.1	
0402	1.00±0.10	0.50±0.10	0.15~0.3	0.50±0.10	G
	1.00-0.5/ + 0.20	0.50-0.5/ + 0.20	0.15~0.35	0.50-0.5/ + 0.20	
0603	1.60±0.10	0.80±0.10	0.2~0.6	0.80±0.10	J
	1.60±0.20	0.80±0.20	0.2~0.65	0.80±0.20	
	1.60±0.30	0.80±0.30	0.2~0.65	0.80±0.30	
0805	2.00±0.10	1.25±0.10	0.2~0.7	0.60±0.10	H
				0.85±0.10	K
				1.25±0.20	M
				0.60±0.10	H
				0.85±0.20	K
1206	3.20±0.20	1.60±0.20	0.3~0.8	1.25±0.20	M
				1.6±0.20	N
				0.85±0.10	K
				1.25±0.20	M
				1.6±0.30	N
1210	3.20±0.30	2.5±0.20	0.3~0.8	0.85±0.10	K
				1.25±0.20	M
				1.6±0.20	N
				2.0±0.20	Q
				2.5±0.30	R
1210	3.20±0.4	2.5±0.30	0.3~0.8	0.85±0.10	K
				1.25±0.20	M
				1.6±0.30	N
				2.0±0.20	Q
				2.5±0.30	R

## COG系列容值范围表

产品等级	材质	尺寸 (inch)	电压 (Vdc)	pF				nF			uF			容值范围	
				0.1	1	10	100	1	10	100	1	10	100		
普通品	COG	125°C	01005	16	[0.3pF, 27pF]										0.3pF ~ 27pF
			0201	25	[0.2pF, 100pF]										0.2pF ~ 100pF
			0201	50	[1.0pF, 100pF]										1.0pF ~ 100pF
			0402	16					[1.0nF, 1.0nF]						1.0nF ~ 1.0nF
			0402	25	[27pF, 180pF]										27pF ~ 180pF
			0402	50	[0.5pF, 1.0nF]										0.5pF ~ 1.0nF
			0402	100	[100pF, 100pF]										100pF ~ 100pF
			0603	25	[680pF, 3.3nF]										680pF ~ 3.3nF
			0603	50	[0.3pF, 5.6nF]										0.3pF ~ 5.6nF
			0603	100	[10pF, 1.0nF]										10pF ~ 1.0nF
			0603	200	[10pF, 470pF]										10pF ~ 470pF
			0603	250	[220pF, 470pF]										220pF ~ 470pF
			0805	25	[3.9nF, 4.7nF]										3.9nF ~ 4.7nF
			0805	50	[0.5pF, 10nF]										0.5pF ~ 10nF
			0805	100	[10pF, 2.2nF]										10pF ~ 2.2nF
			0805	200	[100pF, 1.0nF]										100pF ~ 1.0nF
			0805	250	[100pF, 1.0nF]										100pF ~ 1.0nF
			1206	25	[10nF, 10nF]										10nF ~ 10nF
			1206	50	[1.0pF, 47nF]										1.0pF ~ 47nF
			1206	100	[22pF, 2.2nF]										22pF ~ 2.2nF
			1206	200	[1.0nF, 1.0nF]										1.0nF ~ 1.0nF
			1206	500	[10pF, 1.0nF]										10pF ~ 1.0nF
			1206	630	[10pF, 3.3nF]										10pF ~ 3.3nF
			1206	1000	[10pF, 470pF]										10pF ~ 470pF
			1206	2000	[10pF, 100pF]										10pF ~ 100pF
			1210	50	[10nF, 11nF]										10nF ~ 11nF
			1210	250	[100pF, 4.7nF]										100pF ~ 4.7nF
			1210	500	[100pF, 2.7nF]										100pF ~ 2.7nF
1210	1000	[100pF, 1.0nF]										100pF ~ 1.0nF			
1210	2000	[10pF, 220pF]										10pF ~ 220pF			

## X7R系列容值范围表

产品等级	材质	尺寸 (inch)	电压 (Vdc)	pF				nF			uF			容值范围		
				0.1	1	10	100	1	10	100	1	10	100			
普通品	X7R	125°C	01005	10										100pF ~ 1.0nF		
				16											330pF ~ 330pF	
			0201	6.3												4.7nF ~ 10nF
				10												1.5nF ~ 10nF
				16												150pF ~ 1.0nF
				25												150pF ~ 10nF
			0402	50												180pF ~ 6.8nF
				6.3												100nF ~ 470nF
				10												22nF ~ 470nF
				16												820pF ~ 220nF
			0603	25												560pF ~ 100nF
				50												180pF ~ 100nF
				6.3												10nF ~ 10μF
				10												10nF ~ 2.2μF
				16												10nF ~ 1.0μF
				25												4.7nF ~ 1.0μF
				50												100pF ~ 1.0uF
				100												1.0nF ~ 100nF
			0805	200												100pF ~ 6.8nF
				250												100pF ~ 6.8nF
				6.3												680nF ~ 10μF
				10												680nF ~ 10μF
			1206	16												100nF ~ 10μF
				25												1.0nF ~ 4.7μF
				50												180pF ~ 1.0μF
				100												180pF ~ 220nF
			1206	200												220pF ~ 10nF
				250												100pF ~ 10nF
				6.3												470nF ~ 22μF
				10												470nF ~ 22μF
1206	16												330nF ~ 10μF			
	25												220nF ~ 10μF			



## X7R系列容值范围表

产品等级	材质	尺寸 (inch)	电压 (Vdc)	pF			nF			uF			容值范围	
				0.1	1	10	100	1	10	100	1	10		100
普通品	X7R	1206	35									█	10uF ~ 10μF	
			50											220pF ~ 10μF
			100											2.2nF ~ 2.2μF
			200											470pF ~ 100nF
			250											33nF ~ 100nF
			500											220pF ~ 33nF
			630											330pF ~ 33nF
			1000											100pF ~ 10nF
			2000											100pF ~ 1.0nF
			1210	6.3										
		10												470nF ~ 47μF
		16												470nF ~ 22μF
		25												470nF ~ 22μF
		35												10μF ~ 10μF
		50												470nF ~ 10μF
		100												100nF ~ 2.2μF
		250												10nF ~ 220nF
		500												220pF ~ 47nF
		630												220pF ~ 47nF
		1000											220pF ~ 15nF	
2000											220pF ~ 2.2nF			

## X5R系列容值范围表

产品等级	材质	尺寸 (inch)	电压 (Vdc)	pF			nF			容值范围					
				0.1	1	10	100	1	10		100	1	10	100	
普通品	X5R	85°C	01005	6.3									1nF ~ 100nF		
				10										1nF ~ 10nF	
			0201	6.3											15nF ~ 1.0μF
				10											4.7nF ~ 1.0μF
				16											3.3nF ~ 100nF
				25											1.0nF ~ 100nF
			0402	6.3											100nF ~ 4.7μF
				10											100nF ~ 4.7μF
				16											100nF ~ 2.2μF
				25											100nF ~ 2.2μF
				35											1.0μF ~ 1.0μF
			0603	50											100pF ~ 100nF
				6.3											470nF ~ 22μF
				10											220nF ~ 22μF
				16											220nF ~ 22μF
				25											100nF ~ 10μF
				35											1.0μF ~ 4.7μF
			0805	50											220pF ~ 2.2μF
				6.3											470nF ~ 47μF
				10											470nF ~ 22μF
				16											100nF ~ 22μF
				25											100nF ~ 22μF
				35											4.7μF ~ 4.7μF
			1206	50											220pF ~ 10μF
6.3												470nF ~ 47μF			
10												470nF ~ 47μF			
16												220nF ~ 22μF			
25												100nF ~ 22μF			
35												4.7μF ~ 4.7μF			
												220pF ~ 10μF			

## X5R系列容值范围表

产品等级	材质	尺寸 (inch)	电压 (Vdc)	pF			nF			uF			容值范围
				0.1	1	10	100	1	10	100	1	10	
普通品	X5R 85°C	1210	6.3										470nF ~ 100μF
			10										470nF ~ 100μF
			16										470nF ~ 47μF
			25										470nF ~ 22μF
			35										4.7μF ~ 10μF
			50										

## X6S系列容值范围表

产品等级	材质	尺寸 (inch)	电压 (Vdc)	pF			nF			uF			容值范围	
				0.1	1	10	100	1	10	100	1	10		100
普通品	X6S 105°C	0201	6.3										100nF ~ 220nF	
			10										100nF ~ 220nF	
			16										1.0nF ~ 100nF	
			25										100pF ~ 22nF	
		0402	6.3											220nF ~ 2.2μF
			10											220nF ~ 1.0μF
			16											100nF ~ 680nF
			25											100pF ~ 150nF
		0603	50											100pF ~ 100nF
			6.3											220nF ~ 10μF
			10											220nF ~ 10μF
			16											100nF ~ 10μF
			25											100nF ~ 4.7μF
		0805	50											220pF ~ 1.0μF
			6.3											470nF ~ 22μF
			10											470nF ~ 10μF
			16											220nF ~ 10μF
			25											220nF ~ 10μF
			50											10nF ~ 1.0μF

## X6S系列容值范围表

产品等级	材质	尺寸 (inch)	电压 (Vdc)	pF				nF			uF			容值范围	
				0.1	1	10	100	1	10	100	1	10	100		
普通品	X6S 105°C	1206	6.3											470nF ~ 47μF	
			10												470nF ~ 22μF
			16												220nF ~ 22μF
			25												220nF ~ 22μF
			50												10nF ~ 4.7μF
		1210	6.3												470nF ~ 100μF
			10												470nF ~ 47μF
			16												470nF ~ 22μF
			25												470nF ~ 22μF
			50												470nF ~ 10μF

## C0G系列料号表

尺寸: 01005(公制: 0.4mmx0.2mm)

序号	HRE料号	材质	容值	容差	耐压	最大厚度 (mm)
1	CSA01R5C0G0R3B160DT	C0G	0.3pF	±0.10pF	16V	0.22
2	CSA01R5C0G0R4B160DT	C0G	0.4pF	±0.10pF	16V	0.22
3	CSA01R5C0G0R5B160DT	C0G	0.5pF	±0.10pF	16V	0.22
4	CSA01R5C0G0R9A160DT	C0G	0.9pF	±0.10pF	16V	0.22
5	CSA01R5C0G1R0B160DT	C0G	1.0pF	±0.10pF	16V	0.22
6	CSA01R5C0G1R2B160DT	C0G	1.2pF	±0.10pF	16V	0.22
7	CSA01R5C0G1R5B160DT	C0G	1.5pF	±0.10pF	16V	0.22
8	CSA01R5C0G1R6B160DT	C0G	1.6pF	±0.10pF	16V	0.22
9	CSA01R5C0G1R7B160DT	C0G	1.7pF	±0.10pF	16V	0.22
10	CSA01R5C0G1R8B160DT	C0G	1.8pF	±0.10pF	16V	0.22
11	CSA01R5C0G2R0B160DT	C0G	2.0pF	±0.10pF	16V	0.22
12	CSA01R5C0G2R4B160DT	C0G	2.4pF	±0.10pF	16V	0.22
13	CSA01R5C0G2R9B160DT	C0G	2.9pF	±0.10pF	16V	0.22
14	CSA01R5C0G3R0B160DT	C0G	3.0pF	±0.10pF	16V	0.22
15	CSA01R5C0G3R3C160DT	C0G	3.3pF	±0.25pF	16V	0.22
16	CSA01R5C0G4R0B160DT	C0G	4.0pF	±0.10pF	16V	0.22
17	CSA01R5C0G5R6B160DT	C0G	5.6pF	±0.10pF	16V	0.22
18	CSA01R5C0G5R6C160DT	C0G	5.6pF	±0.25pF	16V	0.22
19	CSA01R5C0G220G160DT	C0G	22pF	±2%	16V	0.22
20	CSA01R5C0G270J160DT	C0G	27pF	±5%	16V	0.22

尺寸: 0201(公制: 0.6mmx0.3mm)

序号	HRE料号	材质	容值	容差	耐压	最大厚度 (mm)
1	CSA0201C0G0R2B250ET	C0G	0.2pF	±0.10pF	25V	0.33
2	CSA0201C0G0R3B250ET	C0G	0.3pF	±0.10pF	25V	0.33
3	CSA0201C0G0R4B250ET	C0G	0.4pF	±0.10pF	25V	0.33
4	CSA0201C0G0R4C250ET	C0G	0.4pF	±0.25pF	25V	0.33
5	CSA0201C0G0R5B250ET	C0G	0.5pF	±0.10pF	25V	0.33
6	CSA0201C0G0R5C250ET	C0G	0.5pF	±0.25pF	25V	0.33
7	CSA0201C0G0R6B250ET	C0G	0.6pF	±0.10pF	25V	0.33
8	CSA0201C0G0R6C250ET	C0G	0.6pF	±0.25pF	25V	0.33
9	CSA0201C0G0R7B250ET	C0G	0.7pF	±0.10pF	25V	0.33
10	CSA0201C0G0R8B250ET	C0G	0.8pF	±0.10pF	25V	0.33
11	CSA0201C0G0R8C250ET	C0G	0.8pF	±0.25pF	25V	0.33
12	CSA0201C0G0R9B250ET	C0G	0.9pF	±0.10pF	25V	0.33

## COG系列料号表

尺寸：0201(公制：0.6mmx0.3mm)

序号	HRE料号	材质	容值	容差	耐压	最大厚度 (mm)
13	CSA0201COG0R9C250ET	COG	0.9pF	±0.25pF	25V	0.33
14	CSA0201COG1R0B250ET	COG	1.0pF	±0.10pF	25V	0.33
15	CSA0201COG1R0C250ET	COG	1.0pF	±0.25pF	25V	0.33
16	CSA0201COG1R0B500ET	COG	1.0pF	±0.10pF	50V	0.33
17	CSA0201COG1R2B250ET	COG	1.2pF	±0.10pF	25V	0.33
18	CSA0201COG1R2C250ET	COG	1.2pF	±0.25pF	25V	0.33
19	CSA0201COG1R2B500ET	COG	1.2pF	±0.10pF	50V	0.33
20	CSA0201COG1R3B250ET	COG	1.3pF	±0.10pF	25V	0.33
21	CSA0201COG1R5C250ET	COG	1.5pF	±0.25pF	25V	0.33
22	CSA0201COG1R5B500ET	COG	1.5pF	±0.10pF	50V	0.33
23	CSA0201COG1R6B250ET	COG	1.6pF	±0.10pF	25V	0.33
24	CSA0201COG1R8B250ET	COG	1.8pF	±0.10pF	25V	0.33
25	CSA0201COG1R8C250ET	COG	1.8pF	±0.25pF	25V	0.33
26	CSA0201COG2R0B250ET	COG	2.0pF	±0.10pF	25V	0.33
27	CSA0201COG2R2B250ET	COG	2.2pF	±0.10pF	25V	0.33
28	CSA0201COG2R2C250ET	COG	2.2pF	±0.25pF	25V	0.33
29	CSA0201COG2R4B250ET	COG	2.4pF	±0.10pF	25V	0.33
30	CSA0201COG2R4C250ET	COG	2.4pF	±0.25pF	25V	0.33
31	CSA0201COG2R6B250ET	COG	2.6pF	±0.10pF	25V	0.33
32	CSA0201COG2R7B250ET	COG	2.7pF	±0.10pF	25V	0.33
33	CSA0201COG2R7C250ET	COG	2.7pF	±0.25pF	25V	0.33
34	CSA0201COG2R7B500ET	COG	2.7pF	±0.10pF	50V	0.33
35	CSA0201COG3R0B250ET	COG	3.0pF	±0.10pF	25V	0.33
36	CSA0201COG3R0C500ET	COG	3.0pF	±0.25pF	50V	0.33
37	CSA0201COG3R3B500ET	COG	3.3pF	±0.10pF	50V	0.33
38	CSA0201COG3R6B250ET	COG	3.6pF	±0.10pF	25V	0.33
39	CSA0201COG3R6C250ET	COG	3.6pF	±0.25pF	25V	0.33
40	CSA0201COG3R9B250ET	COG	3.9pF	±0.10pF	25V	0.33
41	CSA0201COG4R3B250ET	COG	4.3pF	±0.10pF	25V	0.33
42	CSA0201COG4R3C250ET	COG	4.3pF	±0.25pF	25V	0.33
43	CSA0201COG4R7C250ET	COG	4.7pF	±0.25pF	25V	0.33
44	CSA0201COG5R0C250ET	COG	5.0pF	±0.25pF	25V	0.33
45	CSA0201COG5R1B250ET	COG	5.1pF	±0.10pF	25V	0.33
46	CSA0201COG5R1C250ET	COG	5.1pF	±0.25pF	25V	0.33
47	CSA0201COG5R6B250ET	COG	5.6pF	±0.10pF	25V	0.33
48	CSA0201COG5R6C250ET	COG	5.6pF	±0.25pF	25V	0.33

## COG系列料号表

尺寸: 0201(公制: 0.6mmx0.3mm)

序号	HRE料号	材质	容值	容差	耐压	最大厚度 (mm)
49	CSA0201COG6R8B250ET	COG	6.8pF	±0.10pF	25V	0.33
50	CSA0201COG6R8C250ET	COG	6.8pF	±0.25pF	25V	0.33
51	CSA0201COG7R0B250ET	COG	7.0pF	±0.10pF	25V	0.33
52	CSA0201COG7R5B250ET	COG	7.5pF	±0.10pF	25V	0.33
53	CSA0201COG8R0B250ET	COG	8.0pF	±0.10pF	25V	0.33
54	CSA0201COG8R2B250ET	COG	8.2pF	±0.10pF	25V	0.33
55	CSA0201COG8R2C250ET	COG	8.2pF	±0.25pF	25V	0.33
56	CSA0201COG9R0C250ET	COG	9.0pF	±0.25pF	25V	0.33
57	CSA0201COG100D250ET	COG	10pF	±0.50pF	25V	0.33
58	CSA0201COG100J250ET	COG	10pF	±5%	25V	0.33
59	CSA0201COG100J500ET	COG	10pF	±5%	50V	0.33
60	CSA0201COG110G250ET	COG	11pF	±2%	25V	0.33
61	CSA0201COG110J250ET	COG	11pF	±5%	25V	0.33
62	CSA0201COG120J250ET	COG	12pF	±5%	25V	0.33
63	CSA0201COG130J250ET	COG	13pF	±5%	25V	0.33
64	CSA0201COG150J250ET	COG	15pF	±5%	25V	0.33
65	CSA0201COG160G250ET	COG	16pF	±2%	25V	0.33
66	CSA0201COG160J250ET	COG	16pF	±5%	25V	0.33
67	CSA0201COG180J250ET	COG	18pF	±5%	25V	0.33
68	CSA0201COG200J250ET	COG	20pF	±5%	25V	0.33
69	CSA0201COG220G250ET	COG	22pF	±2%	25V	0.33
70	CSA0201COG220J250ET	COG	22pF	±5%	25V	0.33
71	CSA0201COG240J250ET	COG	24pF	±5%	25V	0.33
72	CSA0201COG270G250ET	COG	27pF	±2%	25V	0.33
73	CSA0201COG270J250ET	COG	27pF	±5%	25V	0.33
74	CSA0201COG330J250ET	COG	33pF	±5%	25V	0.33
75	CSA0201COG330J500ET	COG	33pF	±5%	50V	0.33
76	CSA0201COG390J250ET	COG	39pF	±5%	25V	0.33
77	CSA0201COG470J250ET	COG	47pF	±5%	25V	0.33
78	CSA0201COG560J250ET	COG	56pF	±5%	25V	0.33
79	CSA0201COG680J250ET	COG	68pF	±5%	25V	0.33
80	CSA0201COG820J250ET	COG	82pF	±5%	25V	0.33
81	CSA0201COG101J250ET	COG	100pF	±5%	25V	0.33
82	CSA0201COG101J500ET	COG	100pF	±5%	50V	0.33

## C0G系列料号表

尺寸: 0402(公制: 1.0mmx0.5mm)

序号	HRE料号	材质	容值	容差	耐压	最大厚度 (mm)
1	CSA0402C0G0R5B500GT	C0G	0.5pF	±0.10pF	50V	0.60
2	CSA0402C0GR75B500GT	C0G	0.75pF	±0.10pF	50V	0.60
3	CSA0402C0G1R0B500GT	C0G	1.0pF	±0.10pF	50V	0.60
4	CSA0402C0G1R0C500GT	C0G	1.0pF	±0.25pF	50V	0.60
5	CSA0402C0G1R2B500GT	C0G	1.2pF	±0.10pF	50V	0.60
6	CSA0402C0G1R2C500GT	C0G	1.2pF	±0.25pF	50V	0.60
7	CSA0402C0G1R3B500GT	C0G	1.3pF	±0.10pF	50V	0.60
8	CSA0402C0G1R5B500GT	C0G	1.5pF	±0.10pF	50V	0.60
9	CSA0402C0G1R5C500GT	C0G	1.5pF	±0.25pF	50V	0.60
10	CSA0402C0G1R8B500GT	C0G	1.8pF	±0.10pF	50V	0.60
11	CSA0402C0G2R0B500GT	C0G	2.0pF	±0.10pF	50V	0.60
12	CSA0402C0G2R2B500GT	C0G	2.2pF	±0.10pF	50V	0.60
13	CSA0402C0G2R4B500GT	C0G	2.4pF	±0.10pF	50V	0.60
14	CSA0402C0G2R4C500GT	C0G	2.4pF	±0.25pF	50V	0.60
15	CSA0402C0G2R5B500GT	C0G	2.5pF	±0.10pF	50V	0.60
16	CSA0402C0G2R5C500GT	C0G	2.5pF	±0.25pF	50V	0.60
17	CSA0402C0G2R7B500GT	C0G	2.7pF	±0.10pF	50V	0.60
18	CSA0402C0G3R3B500GT	C0G	3.3pF	±0.10pF	50V	0.60
19	CSA0402C0G3R3C500GT	C0G	3.3pF	±0.25pF	50V	0.60
20	CSA0402C0G3R6C500GT	C0G	3.6pF	±0.25pF	50V	0.60
21	CSA0402C0G3R9C500GT	C0G	3.9pF	±0.25pF	50V	0.60
22	CSA0402C0G4R7C500GT	C0G	4.7pF	±0.25pF	50V	0.60
23	CSA0402C0G5R0B500GT	C0G	5.0pF	±0.10pF	50V	0.60
24	CSA0402C0G5R0C500GT	C0G	5.0pF	±0.25pF	50V	0.60
25	CSA0402C0G5R1B500GT	C0G	5.1pF	±0.10pF	50V	0.60
26	CSA0402C0G5R6B500GT	C0G	5.6pF	±0.10pF	50V	0.60
27	CSA0402C0G5R6C500GT	C0G	5.6pF	±0.25pF	50V	0.60
28	CSA0402C0G6R0C500GT	C0G	6.0pF	±0.25pF	50V	0.60
29	CSA0402C0G6R0D500GT	C0G	6.0pF	±0.50pF	50V	0.60
30	CSA0402C0G6R2C500GT	C0G	6.2pF	±0.25pF	50V	0.60
31	CSA0402C0G6R2D500GT	C0G	6.2pF	±0.50pF	50V	0.60
32	CSA0402C0G6R8C500GT	C0G	6.8pF	±0.25pF	50V	0.60
33	CSA0402C0G7R0C500GT	C0G	7.0pF	±0.25pF	50V	0.60
34	CSA0402C0G7R0D500GT	C0G	7.0pF	±0.50pF	50V	0.60
35	CSA0402C0G8R0C500GT	C0G	8.0pF	±0.25pF	50V	0.60



## C0G系列料号表

尺寸: 0402(公制: 1.0mmx0.5mm)

序号	HRE料号	材质	容值	容差	耐压	最大厚度 (mm)
36	CSA0402C0G8R2C500GT	C0G	8.2pF	±0.25pF	50V	0.60
37	CSA0402C0G9R0C500GT	C0G	9.0pF	±0.25pF	50V	0.60
38	CSA0402C0G9R0D500GT	C0G	9.0pF	±0.50pF	50V	0.60
39	CSA0402C0G100C500GT	C0G	10pF	±0.25pF	50V	0.60
40	CSA0402C0G100D500GT	C0G	10pF	±0.50pF	50V	0.60
41	CSA0402C0G110G500GT	C0G	11pF	±2%	50V	0.60
42	CSA0402C0G110J500GT	C0G	11pF	±5%	50V	0.60
43	CSA0402C0G120G500GT	C0G	12pF	±2%	50V	0.60
44	CSA0402C0G120J500GT	C0G	12pF	±5%	50V	0.60
45	CSA0402C0G150J500GT	C0G	15pF	±5%	50V	0.60
46	CSA0402C0G160J500GT	C0G	16pF	±5%	50V	0.60
47	CSA0402C0G180G500GT	C0G	18pF	±2%	50V	0.60
48	CSA0402C0G180J500GT	C0G	18pF	±5%	50V	0.60
49	CSA0402C0G200G500GT	C0G	20pF	±2%	50V	0.60
50	CSA0402C0G220J500GT	C0G	22pF	±5%	50V	0.60
51	CSA0402C0G240J500GT	C0G	24pF	±5%	50V	0.60
52	CSA0402C0G270J250GT	C0G	27pF	±5%	25V	0.60
53	CSA0402C0G270J500GT	C0G	27pF	±5%	50V	0.60
54	CSA0402C0G300J500GT	C0G	30pF	±5%	50V	0.60
55	CSA0402C0G330J500GT	C0G	33pF	±5%	50V	0.60
56	CSA0402C0G360J500GT	C0G	36pF	±5%	50V	0.60
57	CSA0402C0G390J500GT	C0G	39pF	±5%	50V	0.60
58	CSA0402C0G430J500GT	C0G	43pF	±5%	50V	0.60
59	CSA0402C0G470J500GT	C0G	47pF	±5%	50V	0.60
60	CSA0402C0G560J500GT	C0G	56pF	±5%	50V	0.60
61	CSA0402C0G680G500GT	C0G	68pF	±2%	50V	0.60
62	CSA0402C0G680J500GT	C0G	68pF	±5%	50V	0.60
63	CSA0402C0G750J500GT	C0G	75pF	±5%	50V	0.60
64	CSA0402C0G820J500GT	C0G	82pF	±5%	50V	0.60
65	CSA0402C0G910J500GT	C0G	91pF	±5%	50V	0.60
66	CSA0402C0G101J500GT	C0G	100pF	±5%	50V	0.60
67	CSA0402C0G101K500GT	C0G	100pF	±10%	50V	0.60
68	CSA0402C0G101J101GT	C0G	100pF	±5%	100V	0.60
69	CSA0402C0G121J500GT	C0G	120pF	±5%	50V	0.60
70	CSA0402C0G151J500GT	C0G	150pF	±5%	50V	0.60
71	CSA0402C0G181J250GT	C0G	180pF	±5%	25V	0.60
72	CSA0402C0G181J500GT	C0G	180pF	±5%	50V	0.60

## C0G系列料号表

尺寸: 0402(公制: 1.0mmx0.5mm)

序号	HRE料号	材质	容值	容差	耐压	最大厚度 (mm)
73	CSA0402C0G201J500GT	C0G	200pF	±5%	50V	0.60
74	CSA0402C0G221J500GT	C0G	220pF	±5%	50V	0.60
75	CSA0402C0G271J500GT	C0G	270pF	±5%	50V	0.60
76	CSA0402C0G331J500GT	C0G	330pF	±5%	50V	0.60
77	CSA0402C0G391J500GT	C0G	390pF	±5%	50V	0.60
78	CSA0402C0G471J500GT	C0G	470pF	±5%	50V	0.60
79	CSA0402C0G681J500GT	C0G	680pF	±5%	50V	0.60
80	CSA0402C0G821J500GT	C0G	820pF	±5%	50V	0.60
81	CSA0402C0G102J160GT	C0G	1.0nF	±5%	16V	0.60
82	CSA0402C0G102J500GT	C0G	1.0nF	±5%	50V	0.60

尺寸: 0603(公制: 1.6mmx0.8mm)

序号	HRE料号	材质	容值	容差	耐压	最大厚度 (mm)
1	CSA0603C0G0R3B500JT	C0G	0.3pF	±0.10pF	50V	0.90
2	CSA0603C0G0R5C500JT	C0G	0.5pF	±0.25pF	50V	0.90
3	CSA0603C0GR56B500JT	C0G	0.56pF	±0.10pF	50V	0.90
4	CSA0603C0GR75C500JT	C0G	0.75pF	±0.25pF	50V	0.90
5	CSA0603C0G0R8B500JT	C0G	0.8pF	±0.10pF	50V	0.90
6	CSA0603C0G1R0B500JT	C0G	1.0pF	±0.10pF	50V	0.90
7	CSA0603C0G1R8B500JT	C0G	1.8pF	±0.10pF	50V	0.90
8	CSA0603C0G2R0C500JT	C0G	2.0pF	±0.25pF	50V	0.90
9	CSA0603C0G2R2C500JT	C0G	2.2pF	±0.25pF	50V	0.90
10	CSA0603C0G2R4B500JT	C0G	2.4pF	±0.10pF	50V	0.90
11	CSA0603C0G2R4C500JT	C0G	2.4pF	±0.25pF	50V	0.90
12	CSA0603C0G3R5C500JT	C0G	3.5pF	±0.25pF	50V	0.90
13	CSA0603C0G3R6B500JT	C0G	3.6pF	±0.10pF	50V	0.90
14	CSA0603C0G3R6C500JT	C0G	3.6pF	±0.25pF	50V	0.90
15	CSA0603C0G4R0B500JT	C0G	4.0pF	±0.10pF	50V	0.90
16	CSA0603C0G4R0C500JT	C0G	4.0pF	±0.25pF	50V	0.90
17	CSA0603C0G4R3B500JT	C0G	4.3pF	±0.10pF	50V	0.90
18	CSA0603C0G4R7B500JT	C0G	4.7pF	±0.10pF	50V	0.90
19	CSA0603C0G5R0B500JT	C0G	5.0pF	±0.10pF	50V	0.90
20	CSA0603C0G5R0C500JT	C0G	5.0pF	±0.25pF	50V	0.90
21	CSA0603C0G5R0D500JT	C0G	5.0pF	±0.5pF	50V	0.90
22	CSA0603C0G5R1C500JT	C0G	5.1pF	±0.25pF	50V	0.90

## C0G系列料号表

尺寸: 0603(公制: 1.6mmx0.8mm)

序号	HRE料号	材质	容值	容差	耐压	最大厚度 (mm)
23	CSA0603C0G5R6B500JT	C0G	5.6pF	±0.10pF	50V	0.90
24	CSA0603C0G5R6D500JT	C0G	5.6pF	±0.50pF	50V	0.90
25	CSA0603C0G6R0D500JT	C0G	6.0pF	±0.5pF	50V	0.90
26	CSA0603C0G6R2C500JT	C0G	6.2pF	±0.25pF	50V	0.90
27	CSA0603C0G6R2D500JT	C0G	6.2pF	±0.5pF	50V	0.90
28	CSA0603C0G6R8C500JT	C0G	6.8pF	±0.25pF	50V	0.90
29	CSA0603C0G7R0B500JT	C0G	7.0pF	±0.10pF	50V	0.90
30	CSA0603C0G7R0C500JT	C0G	7.0pF	±0.25pF	50V	0.90
31	CSA0603C0G7R0D500JT	C0G	7.0pF	±0.5pF	50V	0.90
32	CSA0603C0G7R5B500JT	C0G	7.5pF	±0.10pF	50V	0.90
33	CSA0603C0G7R5C500JT	C0G	7.5pF	±0.25pF	50V	0.90
34	CSA0603C0G7R5D500JT	C0G	7.5pF	±0.50pF	50V	0.90
35	CSA0603C0G8R2D500JT	C0G	8.2pF	±0.50pF	50V	0.90
36	CSA0603C0G9R1C500JT	C0G	9.1pF	±0.25pF	50V	0.90
37	CSA0603C0G9R1D500JT	C0G	9.1pF	±0.50pF	50V	0.90
38	CSA0603C0G100B500JT	C0G	10pF	±0.10pF	50V	0.90
39	CSA0603C0G100C500JT	C0G	10pF	±0.25pF	50V	0.90
40	CSA0603C0G100J500JT	C0G	10pF	±5%	50V	0.90
41	CSA0603C0G100K500JT	C0G	10pF	±10%	50V	0.90
42	CSA0603C0G100J101JT	C0G	10pF	±5%	100V	0.90
43	CSA0603C0G100J201JT	C0G	10pF	±5%	200V	0.90
44	CSA0603C0G100J251JT	C0G	10pF	±5%	250V	0.90
45	CSA0603C0G110J500JT	C0G	11pF	±5%	50V	0.90
46	CSA0603C0G120J500JT	C0G	12pF	±5%	50V	0.90
47	CSA0603C0G120J101JT	C0G	12pF	±5%	100V	0.90
48	CSA0603C0G120J201JT	C0G	12pF	±5%	200V	0.90
49	CSA0603C0G120J251JT	C0G	12pF	±5%	250V	0.90
50	CSA0603C0G130J500JT	C0G	13pF	±5%	50V	0.90
51	CSA0603C0G140J500JT	C0G	14pF	±5%	50V	0.90
52	CSA0603C0G150J500JT	C0G	15pF	±5%	50V	0.90
53	CSA0603C0G150K500JT	C0G	15pF	±10%	50V	0.90
54	CSA0603C0G150J101JT	C0G	15pF	±5%	100V	0.90
55	CSA0603C0G150J201JT	C0G	15pF	±5%	200V	0.90
56	CSA0603C0G150J251JT	C0G	15pF	±5%	250V	0.90
57	CSA0603C0G160J500JT	C0G	16pF	±5%	50V	0.90
58	CSA0603C0G180J500JT	C0G	18pF	±5%	50V	0.90

## C0G系列料号表

尺寸: 0603(公制: 1.6mmx0.8mm)

序号	一般料号(含中高压)	材质	容值	容差	耐压	最大厚度 (mm)
59	CSA0603C0G180J101JT	C0G	18pF	±5%	100V	0.90
60	CSA0603C0G180J201JT	C0G	18pF	±5%	200V	0.90
61	CSA0603C0G180J251JT	C0G	18pF	±5%	250V	0.90
62	CSA0603C0G200J500JT	C0G	20pF	±5%	50V	0.90
63	CSA0603C0G200J101JT	C0G	20pF	±5%	100V	0.90
64	CSA0603C0G200J201JT	C0G	20pF	±5%	200V	0.90
65	CSA0603C0G200J251JT	C0G	20pF	±5%	250V	0.90
66	CSA0603C0G220J500JT	C0G	22pF	±5%	50V	0.90
67	CSA0603C0G220J101JT	C0G	22pF	±5%	100V	0.90
68	CSA0603C0G220J201JT	C0G	22pF	±5%	200V	0.90
69	CSA0603C0G220J251JT	C0G	22pF	±5%	250V	0.90
70	CSA0603C0G240J500JT	C0G	24pF	±5%	50V	0.90
71	CSA0603C0G250J500JT	C0G	25pF	±5%	50V	0.90
72	CSA0603C0G270G500JT	C0G	27pF	±2%	50V	0.90
73	CSA0603C0G270J500JT	C0G	27pF	±5%	50V	0.90
74	CSA0603C0G270J101JT	C0G	27pF	±5%	100V	0.90
75	CSA0603C0G270J201JT	C0G	27pF	±5%	200V	0.90
76	CSA0603C0G270J251JT	C0G	27pF	±5%	250V	0.90
77	CSA0603C0G300J500JT	C0G	30pF	±5%	50V	0.90
78	CSA0603C0G300J101JT	C0G	30pF	±5%	100V	0.90
79	CSA0603C0G300J201JT	C0G	30pF	±5%	200V	0.90
80	CSA0603C0G300J251JT	C0G	30pF	±5%	250V	0.90
81	CSA0603C0G330G500JT	C0G	33pF	±2%	50V	0.90
82	CSA0603C0G330J500JT	C0G	33pF	±5%	50V	0.90
83	CSA0603C0G330K500JT	C0G	33pF	±10%	50V	0.90
84	CSA0603C0G330J101JT	C0G	33pF	±5%	100V	0.90
85	CSA0603C0G330J201JT	C0G	33pF	±5%	200V	0.90
86	CSA0603C0G330J251JT	C0G	33pF	±5%	250V	0.90
87	CSA0603C0G390G500JT	C0G	39pF	±2%	50V	0.90
88	CSA0603C0G390J500JT	C0G	39pF	±5%	50V	0.90
89	CSA0603C0G390J101JT	C0G	39pF	±5%	100V	0.90
90	CSA0603C0G390J201JT	C0G	39pF	±5%	200V	0.90
91	CSA0603C0G390J251JT	C0G	39pF	±5%	250V	0.90
92	CSA0603C0G430J500JT	C0G	43pF	±5%	50V	0.90
93	CSA0603C0G470G500JT	C0G	47pF	±2%	50V	0.90
94	CSA0603C0G470J500JT	C0G	47pF	±5%	50V	0.90

## C0G系列料号表

尺寸: 0603(公制: 1.6mmx0.8mm)

序号	HRE料号	材质	容值	容差	耐压	最大厚度 (mm)
95	CSA0603C0G470J101JT	C0G	47pF	±5%	100V	0.90
96	CSA0603C0G470J201JT	C0G	47pF	±5%	200V	0.90
97	CSA0603C0G470J251JT	C0G	47pF	±5%	250V	0.90
98	CSA0603C0G510J500JT	C0G	51pF	±5%	50V	0.90
99	CSA0603C0G560J500JT	C0G	56pF	±5%	50V	0.90
100	CSA0603C0G620J500JT	C0G	62pF	±5%	50V	0.90
101	CSA0603C0G680G500JT	C0G	68pF	±2%	50V	0.90
102	CSA0603C0G680J500JT	C0G	68pF	±5%	50V	0.90
103	CSA0603C0G680J101JT	C0G	68pF	±5%	100V	0.90
104	CSA0603C0G680J201JT	C0G	68pF	±5%	200V	0.90
105	CSA0603C0G680J251JT	C0G	68pF	±5%	250V	0.90
106	CSA0603C0G820G500JT	C0G	82pF	±2%	50V	0.90
107	CSA0603C0G820J500JT	C0G	82pF	±5%	50V	0.90
108	CSA0603C0G820J101JT	C0G	82pF	±5%	100V	0.90
109	CSA0603C0G820J201JT	C0G	82pF	±5%	200V	0.90
110	CSA0603C0G820J251JT	C0G	82pF	±5%	250V	0.90
111	CSA0603C0G101G500JT	C0G	100pF	±2%	50V	0.90
112	CSA0603C0G101J500JT	C0G	100pF	±5%	50V	0.90
113	CSA0603C0G101J101JT	C0G	100pF	±5%	100V	0.90
114	CSA0603C0G101J201JT	C0G	100pF	±5%	200V	0.90
115	CSA0603C0G101J251JT	C0G	100pF	±5%	250V	0.90
116	CSA0603C0G111J500JT	C0G	110pF	±5%	50V	0.90
117	CSA0603C0G121J500JT	C0G	120pF	±5%	50V	0.90
118	CSA0603C0G121J101JT	C0G	120pF	±5%	100V	0.90
119	CSA0603C0G121J201JT	C0G	120pF	±5%	200V	0.90
120	CSA0603C0G121J251JT	C0G	120pF	±5%	250V	0.90
121	CSA0603C0G151G500JT	C0G	150pF	±2%	50V	0.90
122	CSA0603C0G151J500JT	C0G	150pF	±5%	50V	0.90
123	CSA0603C0G151J101JT	C0G	150pF	±5%	100V	0.90
124	CSA0603C0G151J201JT	C0G	150pF	±5%	200V	0.90
125	CSA0603C0G151J251JT	C0G	150pF	±5%	250V	0.90
126	CSA0603C0G161J500JT	C0G	160pF	±5%	50V	0.90
127	CSA0603C0G181J500JT	C0G	180pF	±5%	50V	0.90
128	CSA0603C0G181J101JT	C0G	180pF	±5%	100V	0.90
129	CSA0603C0G181J201JT	C0G	180pF	±5%	200V	0.90
130	CSA0603C0G181J251JT	C0G	180pF	±5%	250V	0.90

## C0G系列料号表

尺寸: 0603(公制: 1.6mmx0.8mm)

序号	HRE料号	材质	容值	容差	耐压	最大厚度 (mm)
131	CSA0603C0G201J500JT	C0G	200pF	±5%	50V	0.90
132	CSA0603C0G201J101JT	C0G	200pF	±5%	100V	0.90
133	CSA0603C0G201J201JT	C0G	200pF	±5%	200V	0.90
134	CSA0603C0G201J251JT	C0G	200pF	±5%	250V	0.90
135	CSA0603C0G221G500JT	C0G	220pF	±2%	50V	0.90
136	CSA0603C0G221J500JT	C0G	220pF	±5%	50V	0.90
137	CSA0603C0G221K500JT	C0G	220pF	±10%	50V	0.90
138	CSA0603C0G221J101JT	C0G	220pF	±5%	100V	0.90
139	CSA0603C0G221J201JT	C0G	220pF	±5%	200V	0.90
140	CSA0603C0G221J251JT	C0G	220pF	±5%	250V	0.90
141	CSA0603C0G271G500JT	C0G	270pF	±2%	50V	0.90
142	CSA0603C0G271J500JT	C0G	270pF	±5%	50V	0.90
143	CSA0603C0G271J101JT	C0G	270pF	±5%	100V	0.90
144	CSA0603C0G271J201JT	C0G	270pF	±5%	200V	0.90
145	CSA0603C0G271J251JT	C0G	270pF	±5%	250V	0.90
146	CSA0603C0G331G500JT	C0G	330pF	±2%	50V	0.90
147	CSA0603C0G331J500JT	C0G	330pF	±5%	50V	0.90
148	CSA0603C0G331J101JT	C0G	330pF	±5%	100V	0.90
149	CSA0603C0G331J201JT	C0G	330pF	±5%	200V	0.90
150	CSA0603C0G331J251JT	C0G	330pF	±5%	250V	0.90
151	CSA0603C0G361J500JT	C0G	360pF	±5%	50V	0.90
152	CSA0603C0G391J500JT	C0G	390pF	±5%	50V	0.90
153	CSA0603C0G391J101JT	C0G	390pF	±5%	100V	0.90
154	CSA0603C0G391J201JT	C0G	390pF	±5%	200V	0.90
155	CSA0603C0G391J251JT	C0G	390pF	±5%	250V	0.90
156	CSA0603C0G431J500JT	C0G	430pF	±5%	50V	0.90
157	CSA0603C0G471J500JT	C0G	470pF	±5%	50V	0.90
158	CSA0603C0G471J101JT	C0G	470pF	±5%	100V	0.90
159	CSA0603C0G471J201JT	C0G	470pF	±5%	200V	0.90
160	CSA0603C0G471J251JT	C0G	470pF	±5%	250V	0.90
161	CSA0603C0G511J500JT	C0G	510pF	±5%	50V	0.90
162	CSA0603C0G561J500JT	C0G	560pF	±5%	50V	0.90
163	CSA0603C0G681J250JT	C0G	680pF	±5%	25V	0.90
164	CSA0603C0G681J500JT	C0G	680pF	±5%	50V	0.90
165	CSA0603C0G751J500JT	C0G	750pF	±5%	50V	0.90
166	CSA0603C0G821J500JT	C0G	820pF	±5%	50V	0.90

## C0G系列料号表

尺寸: 0603(公制: 1.6mmx0.8mm)

序号	HRE料号	材质	容值	容差	耐压	最大厚度 (mm)
167	CSA0603C0G102J250JT	C0G	1.0nF	±5%	25V	0.90
168	CSA0603C0G102J500JT	C0G	1.0nF	±5%	50V	0.90
169	CSA0603C0G102J101JT	C0G	1.0nF	±5%	100V	0.90
170	CSA0603C0G122J500JT	C0G	1.2nF	±5%	50V	0.90
171	CSA0603C0G152J500JT	C0G	1.5nF	±5%	50V	0.90
172	CSA0603C0G182J500JT	C0G	1.8nF	±5%	50V	0.90
173	CSA0603C0G222J500JT	C0G	2.2nF	±5%	50V	0.90
174	CSA0603C0G272J500JT	C0G	2.7nF	±5%	50V	0.90
175	CSA0603C0G332J250JT	C0G	3.3nF	±5%	25V	0.90
176	CSA0603C0G332J500JT	C0G	3.3nF	±5%	50V	0.90
177	CSA0603C0G472J500JT	C0G	4.7nF	±5%	50V	0.90
178	CSA0603C0G562J500JT	C0G	5.6nF	±5%	50V	0.90

尺寸: 0805(公制: 2.0mmx1.25mm)

序号	HRE料号	材质	容值	容差	耐压	最大厚度 (mm)
1	CSA0805C0G0R5B500HT	C0G	0.5pF	±0.10pF	50V	0.70
2	CSA0805C0G0R5C500HT	C0G	0.5pF	±0.25pF	50V	0.70
3	CSA0805C0G0R6B500HT	C0G	0.68pF	±0.10pF	50V	0.70
4	CSA0805C0G1R0B500HT	C0G	1.0pF	±0.1pF	50V	0.70
5	CSA0805C0G1R2B500HT	C0G	1.2pF	±0.10pF	50V	0.70
6	CSA0805C0G1R2C500HT	C0G	1.2pF	±0.25pF	50V	0.70
7	CSA0805C0G1R5B500HT	C0G	1.5pF	±0.10pF	50V	0.70
8	CSA0805C0G1R5C500HT	C0G	1.5pF	±0.25pF	50V	0.70
9	CSA0805C0G1R8B500HT	C0G	1.8pF	±0.10pF	50V	0.70
10	CSA0805C0G1R8C500HT	C0G	1.8pF	±0.25pF	50V	0.70
11	CSA0805C0G2R2B500HT	C0G	2.2pF	±0.1pF	50V	0.70
12	CSA0805C0G2R4C500HT	C0G	2.4pF	±0.25pF	50V	0.70
13	CSA0805C0G2R5C500HT	C0G	2.5pF	±0.25pF	50V	0.70
14	CSA0805C0G2R7B500HT	C0G	2.7pF	±0.1pF	50V	0.70
15	CSA0805C0G2R7C500HT	C0G	2.7pF	±0.25pF	50V	0.70
16	CSA0805C0G3R0B500HT	C0G	3.0pF	±0.1pF	50V	0.70
17	CSA0805C0G3R0C500HT	C0G	3.0pF	±0.25pF	50V	0.70
18	CSA0805C0G3R9C500HT	C0G	3.9pF	±0.25pF	50V	0.70

## C0G系列料号表

尺寸: 0805(公制: 2.0mmx1.25mm)

序号	HRE料号	材质	容值	容差	耐压	最大厚度 (mm)
19	CSA0805C0G4R7B500HT	C0G	4.7pF	±0.10pF	50V	0.70
20	CSA0805C0G5R0C500HT	C0G	5.0pF	±0.25pF	50V	0.70
21	CSA0805C0G5R6B500HT	C0G	5.6pF	±0.10pF	50V	0.70
22	CSA0805C0G5R6C500HT	C0G	5.6pF	±0.25pF	50V	0.70
23	CSA0805C0G5R6D500HT	C0G	5.6pF	±0.50pF	50V	0.70
24	CSA0805C0G6R0C500HT	C0G	6.0pF	±0.25pF	50V	0.70
25	CSA0805C0G6R0D500HT	C0G	6.0pF	±0.5pF	50V	0.70
26	CSA0805C0G6R8C500HT	C0G	6.8pF	±0.25pF	50V	0.70
27	CSA0805C0G6R8D500HT	C0G	6.8pF	±0.5pF	50V	0.70
28	CSA0805C0G7R0CD500HT	C0G	7.0pF	±0.25pF	50V	0.70
29	CSA0805C0G8R0CD500HT	C0G	8.0pF	±0.25pF	50V	0.70
30	CSA0805C0G8R0D500HT	C0G	8.0pF	±0.5pF	50V	0.70
31	CSA0805C0G8R2D500HT	C0G	8.2pF	±0.5pF	50V	0.70
32	CSA0805C0G9R0CD500HT	C0G	9.0pF	±0.25pF	50V	0.70
33	CSA0805C0G9R0D500HT	C0G	9.0pF	±0.5pF	50V	0.70
34	CSA0805C0G100C500HT	C0G	10pF	±0.25pF	50V	0.70
35	CSA0805C0G100J500HT	C0G	10pF	±5%	50V	0.70
36	CSA0805C0G100C101HT	C0G	10pF	±0.25pF	100V	0.70
37	CSA0805C0G120J500HT	C0G	12pF	±5%	50V	0.70
38	CSA0805C0G130J500HT	C0G	13pF	±5%	50V	0.70
39	CSA0805C0G150G500HT	C0G	15pF	±2%	50V	0.70
40	CSA0805C0G180G101HT	C0G	18pF	±2%	100V	0.70
41	CSA0805C0G200J500HT	C0G	20pF	±5%	50V	0.70
42	CSA0805C0G220G500HT	C0G	22pF	±2%	50V	0.70
43	CSA0805C0G220J500HT	C0G	22pF	±5%	50V	0.70
44	CSA0805C0G240J500HT	C0G	24pF	±5%	50V	0.70
45	CSA0805C0G270J101HT	C0G	27pF	±5%	100V	0.70
46	CSA0805C0G330J500HT	C0G	33pF	±5%	50V	0.70
47	CSA0805C0G330K500HT	C0G	33pF	±10%	50V	0.70
48	CSA0805C0G360J500HT	C0G	36pF	±5%	50V	0.70
49	CSA0805C0G390J500HT	C0G	39pF	±5%	50V	0.70
50	CSA0805C0G430J500HT	C0G	43pF	±5%	50V	0.70
51	CSA0805C0G470J500HT	C0G	47pF	±5%	50V	0.70
52	CSA0805C0G470J101HT	C0G	47pF	±5%	100V	0.70
53	CSA0805C0G510J500HT	C0G	51pF	±5%	50V	0.70
54	CSA0805C0G620J500HT	C0G	62pF	±5%	50V	0.70



## C0G系列料号表

尺寸: 0805(公制: 2.0mmx1.25mm)

序号	HRE料号	材质	容值	容差	耐压	最大厚度 (mm)
55	CSA0805C0G680G500HT	C0G	68pF	±2%	50V	0.70
56	CSA0805C0G680J500HT	C0G	68pF	±5%	50V	0.70
57	CSA0805C0G680J101HT	C0G	68pF	±5%	100V	0.70
58	CSA0805C0G750J500HT	C0G	75pF	±5%	50V	0.70
59	CSA0805C0G820G500HT	C0G	82pF	±2%	50V	0.70
60	CSA0805C0G910J500HT	C0G	91pF	±2%	50V	0.70
61	CSA0805C0G101J500HT	C0G	100pF	±5%	50V	0.70
62	CSA0805C0G101K500HT	C0G	100pF	±10%	50V	0.70
63	CSA0805C0G101J101HT	C0G	100pF	±5%	100V	0.70
64	CSA0805C0G101J201HT	C0G	100pF	±5%	200V	0.95
65	CSA0805C0G101J251HT	C0G	100pF	±5%	250V	0.70
66	CSA0805C0G121J201HT	C0G	120pF	±5%	200V	0.95
67	CSA0805C0G151J500HT	C0G	150pF	±5%	50V	0.70
68	CSA0805C0G151J101HT	C0G	150pF	±5%	100V	0.70
69	CSA0805C0G151J251HT	C0G	150pF	±5%	250V	0.70
70	CSA0805C0G181J500HT	C0G	180pF	±5%	50V	0.70
71	CSA0805C0G201J500HT	C0G	200pF	±5%	50V	0.70
72	CSA0805C0G221G500HT	C0G	220pF	±2%	50V	0.70
73	CSA0805C0G221J500HT	C0G	220pF	±5%	50V	0.70
74	CSA0805C0G221J201HT	C0G	220pF	±5%	200V	0.95
75	CSA0805C0G271G500HT	C0G	270pF	±2%	50V	0.70
76	CSA0805C0G271J500HT	C0G	270pF	±5%	50V	0.70
77	CSA0805C0G301J500HT	C0G	300pF	±5%	50V	0.70
78	CSA0805C0G331G500HT	C0G	330pF	±2%	50V	0.70
79	CSA0805C0G331J500HT	C0G	330pF	±5%	50V	0.70
80	CSA0805C0G331J101HT	C0G	330pF	±5%	100V	0.70
81	CSA0805C0G331J251HT	C0G	330pF	±5%	250V	0.70
82	CSA0805C0G361J500HT	C0G	360pF	±5%	50V	0.70
83	CSA0805C0G391G500HT	C0G	390pF	±2%	50V	0.70
84	CSA0805C0G391J500HT	C0G	390pF	±5%	50V	0.70
85	CSA0805C0G471G500HT	C0G	470pF	±2%	50V	0.70
86	CSA0805C0G471J500HT	C0G	470pF	±5%	50V	0.70
87	CSA0805C0G471J101HT	C0G	470pF	±5%	100V	0.95
88	CSA0805C0G471J251HT	C0G	470pF	±5%	250V	0.95
89	CSA0805C0G621J500HT	C0G	620pF	±5%	50V	0.95
90	CSA0805C0G681J500HT	C0G	680pF	±5%	50V	0.95

## C0G系列料号表

尺寸: 0805(公制: 2.0mmx1.25mm)

序号	HRE料号	材质	容值	容差	耐压	最大厚度 (mm)
91	CSA0805C0G681J101HT	C0G	680pF	±5%	100V	0.95
92	CSA0805C0G681J251HT	C0G	680pF	±5%	250V	0.95
93	CSA0805C0G911J500HT	C0G	910pF	±5%	50V	0.95
94	CSA0805C0G102G500HT	C0G	1.0nF	±2%	50V	0.95
95	CSA0805C0G102J500HT	C0G	1.0nF	±5%	50V	0.95
96	CSA0805C0G102J101HT	C0G	1.0nF	±5%	100V	1.45
97	CSA0805C0G102J201HT	C0G	1.0nF	±5%	200V	1.45
98	CSA0805C0G102J251HT	C0G	1.0nF	±5%	250V	1.45
99	CSA0805C0G122J500HT	C0G	1.2nF	±5%	50V	1.45
100	CSA0805C0G152J500HT	C0G	1.5nF	±5%	50V	1.45
101	CSA0805C0G182J500HT	C0G	1.8nF	±5%	50V	1.45
102	CSA0805C0G202G500HT	C0G	2.2nF	±2%	50V	1.45
103	CSA0805C0G202J500HT	C0G	2.2nF	±5%	50V	1.45
104	CSA0805C0G202J101HT	C0G	2.2nF	±5%	100V	1.45
105	CSA0805C0G272J500HT	C0G	2.7nF	±5%	50V	1.45
106	CSA0805C0G392J250KT	C0G	3.9nF	±5%	25V	0.95
107	CSA0805C0G472J250KT	C0G	4.7nF	±5%	25V	0.95
108	CSA0805C0G472J500HT	C0G	4.7nF	±5%	50V	1.45
109	CSA0805C0G562J500HT	C0G	5.6nF	±5%	50V	1.45
110	CSA0805C0G103J500HT	C0G	10nF	±5%	50V	1.45

尺寸: 1206(公制: 3.2mmx1.6mm)

序号	HRE料号	材质	容值	容差	耐压	最大厚度 (mm)
1	CSA1206C0G1R0C500KT	C0G	1.0pF	±0.25pF	50V	0.95
2	CSA1206C0G2R2C500KT	C0G	2.2pF	±0.25pF	50V	0.95
3	CSA1206C0G3R9B500KT	C0G	3.9pF	±0.1pF	50V	0.95
4	CSA1206C0G4R7C500KT	C0G	4.7pF	±0.25pF	50V	0.95
5	CSA1206C0G6R8C500KT	C0G	6.8pF	±0.25pF	50V	0.95
6	CSA1206C0G100D500KT	C0G	10pF	±0.5pF	50V	0.95
7	CSA1206C0G100J500KT	C0G	10pF	±5%	50V	0.95
8	CSA1206C0G100J501MT	C0G	10pF	±5%	500V	0.95
9	CSA1206C0G100J631KT	C0G	10pF	±5%	630V	0.95
10	CSA1206C0G100J102KT	C0G	10pF	±5%	1000V	0.95

## COG系列料号表

尺寸: 1206(公制: 3.2mmx1.6mm)

序号	HRE料号	材质	容值	容差	耐压	最大厚度 (mm)
11	CSA1206C0G120J500KT	COG	12pF	±5%	50V	0.95
12	CSA1206C0G150J500KT	COG	15pF	±5%	50V	0.95
13	CSA1206C0G150J631KT	COG	15pF	±5%	630V	0.95
14	CSA1206C0G150J202KT	COG	15pF	±5%	2000V	0.95
15	CSA1206C0G180J500KT	COG	18pF	±5%	50V	0.95
16	CSA1206C0G180J202KT	COG	18pF	±5%	2000V	0.95
17	CSA1206C0G200J500KT	COG	20pF	±5%	50V	0.95
18	CSA1206C0G200J202KT	COG	20pF	±5%	2000V	0.95
19	CSA1206C0G220J500KT	COG	22pF	±5%	50V	0.95
20	CSA1206C0G220J101KT	COG	22pF	±5%	100V	0.95
21	CSA1206C0G220J631KT	COG	22pF	±5%	630V	0.95
22	CSA1206C0G220J102KT	COG	22pF	±5%	1000V	0.95
23	CSA1206C0G220J202MT	COG	22pF	±5%	2000V	1.45
24	CSA1206C0G270J500KT	COG	27pF	±5%	50V	0.95
25	CSA1206C0G270J631KT	COG	27pF	±5%	630V	0.95
26	CSA1206C0G270J202MT	COG	27pF	±5%	2000V	1.45
27	CSA1206C0G300J500KT	COG	30pF	±5%	50V	0.95
28	CSA1206C0G300J202MT	COG	30pF	±5%	2000V	1.45
29	CSA1206C0G330J631KT	COG	33pF	±5%	630V	0.95
30	CSA1206C0G330J102KT	COG	33pF	±5%	1000V	0.95
31	CSA1206C0G330J202MT	COG	33pF	±5%	2000V	1.45
32	CSA1206C0G390J202MT	COG	39pF	±5%	2000V	1.45
33	CSA1206C0G470J631KT	COG	47pF	±5%	630V	0.95
34	CSA1206C0G470J102KT	COG	47pF	±5%	1000V	0.95
35	CSA1206C0G470J202MT	COG	47pF	±5%	2000V	1.45
36	CSA1206C0G560J500KT	COG	56pF	±5%	50V	0.95
37	CSA1206C0G560J202MT	COG	56pF	±5%	2000V	1.45
38	CSA1206C0G680J631KT	COG	68pF	±5%	630V	0.95
39	CSA1206C0G680J102KT	COG	68pF	±5%	1000V	0.95
40	CSA1206C0G680J202MT	COG	68pF	±5%	2000V	1.45
41	CSA1206C0G820J500KT	COG	82pF	±5%	50V	0.95
42	CSA1206C0G820J102KT	COG	82pF	±5%	1000V	0.95
43	CSA1206C0G820J202MT	COG	82pF	±5%	2000V	1.45
44	CSA1206C0G101J500KT	COG	100pF	±5%	50V	0.95
45	CSA1206C0G101K500KT	COG	100pF	±10%	50V	0.95
46	CSA1206C0G101J101KT	COG	100pF	±5%	100V	0.95

## COG系列料号表

尺寸: 1206(公制: 3.2mmx1.6mm)

序号	HRE料号	材质	容值	容差	耐压	最大厚度 (mm)
47	CSA1206C0G101J501KT	COG	100pF	±5%	500V	0.95
48	CSA1206C0G101K501KT	COG	100pF	±10%	500V	0.95
49	CSA1206C0G101J631KT	COG	100pF	±5%	630V	0.95
50	CSA1206C0G101J102MT	COG	100pF	±5%	1000V	1.45
51	CSA1206C0G101J202MT	COG	100pF	±5%	2000V	1.45
52	CSA1206C0G121J500KT	COG	120pF	±5%	50V	0.95
53	CSA1206C0G121J102MT	COG	120pF	±5%	1000V	1.45
54	CSA1206C0G151J501KT	COG	150pF	±5%	500V	0.95
55	CSA1206C0G151J631KT	COG	150pF	±5%	630V	0.95
56	CSA1206C0G151J102MT	COG	150pF	±5%	1000V	1.45
57	CSA1206C0G181J500KT	COG	180pF	±5%	50V	0.95
58	CSA1206C0G181J102MT	COG	180pF	±5%	1000V	1.45
59	CSA1206C0G221J500KT	COG	220pF	±5%	50V	0.95
60	CSA1206C0G221J101KT	COG	220pF	±5%	100V	0.95
61	CSA1206C0G221J501KT	COG	220pF	±5%	500V	0.95
62	CSA1206C0G221J631KT	COG	220pF	±5%	630V	0.95
63	CSA1206C0G221J102MT	COG	220pF	±5%	1000V	1.45
64	CSA1206C0G271J500KT	COG	270pF	±5%	50V	0.95
65	CSA1206C0G271J501KT	COG	270pF	±5%	500V	0.95
66	CSA1206C0G271J102MT	COG	270pF	±5%	1000V	1.45
67	CSA1206C0G331J500KT	COG	330pF	±5%	50V	0.95
68	CSA1206C0G331J631KT	COG	330pF	±5%	630V	0.95
69	CSA1206C0G331J102MT	COG	330pF	±5%	1000V	1.45
70	CSA1206C0G391J500KT	COG	390pF	±5%	50V	0.95
71	CSA1206C0G391J631KT	COG	390pF	±5%	630V	0.95
72	CSA1206C0G391J102MT	COG	390pF	±5%	1000V	1.45
73	CSA1206C0G471J501KT	COG	470pF	±5%	500V	0.95
74	CSA1206C0G471J631KT	COG	470pF	±5%	630V	0.95
75	CSA1206C0G471J102MT	COG	470pF	±5%	1000V	1.45
76	CSA1206C0G561J500KT	COG	560pF	±5%	50V	0.95
77	CSA1206C0G681J500KT	COG	680pF	±5%	50V	0.95
78	CSA1206C0G681J501KT	COG	680pF	±5%	500V	0.95
79	CSA1206C0G681J631KT	COG	680pF	±5%	630V	0.95
80	CSA1206C0G821J500KT	COG	820pF	±5%	50V	0.95
81	CSA1206C0G821J631KT	COG	820pF	±5%	630V	0.95
82	CSA1206C0G102J500KT	COG	1.0nF	±5%	50V	0.95

## COG系列料号表

尺寸: 1206(公制: 3.2mmx1.6mm)

序号	HRE料号	材质	容值	容差	耐压	最大厚度 (mm)
83	CSA1206COG102J201MT	COG	1.0nF	±5%	200V	1.45
84	CSA1206COG102J501KT	COG	1.0nF	±5%	500V	0.95
85	CSA1206COG102J631KT	COG	1.0nF	±5%	630V	0.95
86	CSA1206COG122J500KT	COG	1.2nF	±5%	50V	0.95
87	CSA1206COG122J631KT	COG	1.2nF	±5%	630V	1.80
88	CSA1206COG152J500KT	COG	1.5nF	±5%	50V	0.95
89	CSA1206COG152J101KT	COG	1.5nF	±5%	100V	0.95
90	CSA1206COG152J631KT	COG	1.5nF	±5%	630V	1.80
91	CSA1206COG222J500KT	COG	2.2nF	±5%	50V	0.95
92	CSA1206COG222J101KT	COG	2.2nF	±5%	100V	0.95
93	CSA1206COG222J631KT	COG	2.2nF	±5%	630V	1.80
94	CSA1206COG332J500MT	COG	3.3nF	±5%	50V	1.45
95	CSA1206COG332J631KT	COG	3.3nF	±5%	630V	1.80
96	CSA1206COG103J250MT	COG	10nF	±5%	25V	1.45
97	CSA1206COG223J500NT	COG	22nF	±5%	50V	1.80
98	CSA1206COG473J500NT	COG	47nF	±5%	50V	1.80

尺寸: 1210(公制: 3.2mmx2.5mm)

序号	HRE料号	材质	容值	容差	耐压	最大厚度 (mm)
1	CSA1210COG100J202KT	COG	10pF	±5%	2000V	0.95
2	CSA1210COG120J202KT	COG	12pF	±5%	2000V	0.95
3	CSA1210COG150J202KT	COG	15pF	±5%	2000V	0.95
4	CSA1210COG180J202KT	COG	18pF	±5%	2000V	0.95
5	CSA1210COG200J202KT	COG	20pF	±5%	2000V	0.95
6	CSA1210COG220J202KT	COG	22pF	±5%	2000V	0.95
7	CSA1210COG270J202KT	COG	27pF	±5%	2000V	0.95
8	CSA1210COG300J202KT	COG	30pF	±5%	2000V	0.95
9	CSA1210COG330J202KT	COG	33pF	±5%	2000V	0.95
10	CSA1210COG390J202KT	COG	39pF	±5%	2000V	0.95
11	CSA1210COG470J202KT	COG	47pF	±5%	2000V	0.95
12	CSA1210COG560J202KT	COG	56pF	±5%	2000V	0.95
13	CSA1210COG680J202KT	COG	68pF	±5%	2000V	0.95
14	CSA1210COG820J202KT	COG	82pF	±5%	2000V	0.95

## C0G系列料号表

尺寸: 1210(公制: 3.2mmx2.5mm)

序号	HRE料号	材质	容值	容差	耐压	最大厚度 (mm)
15	CSA1210C0G101J251KT	C0G	100pF	±5%	250V	0.95
16	CSA1210C0G101J501KT	C0G	100pF	±5%	500V	0.95
17	CSA1210C0G101J102KT	C0G	100pF	±5%	1000V	0.95
18	CSA1210C0G101J202KT	C0G	100pF	±5%	2000V	0.95
19	CSA1210C0G121J250KT	C0G	120pF	±5%	250V	0.95
20	CSA1210C0G121J501KT	C0G	120pF	±5%	500V	0.95
21	CSA1210C0G121J102KT	C0G	120pF	±5%	1000V	0.95
22	CSA1210C0G121J202MT	C0G	120pF	±5%	2000V	1.45
23	CSA1210C0G151J251KT	C0G	150pF	±5%	250V	0.95
24	CSA1210C0G151J501KT	C0G	150pF	±5%	500V	0.95
25	CSA1210C0G151J102KT	C0G	150pF	±5%	1000V	0.95
26	CSA1210C0G151J202MT	C0G	150pF	±5%	2000V	1.45
27	CSA1210C0G181J251KT	C0G	180pF	±5%	250V	0.95
28	CSA1210C0G181J501KT	C0G	180pF	±5%	500V	0.95
29	CSA1210C0G181J102KT	C0G	180pF	±5%	1000V	0.95
30	CSA1210C0G181J202MT	C0G	180pF	±5%	2000V	1.45
31	CSA1210C0G201J251KT	C0G	200pF	±5%	250V	0.95
32	CSA1210C0G201J501KT	C0G	200pF	±5%	500V	0.95
33	CSA1210C0G201J102KT	C0G	200pF	±5%	1000V	0.95
34	CSA1210C0G201J202MT	C0G	200pF	±5%	2000V	1.45
35	CSA1210C0G221J251KT	C0G	220pF	±5%	250V	0.95
36	CSA1210C0G221J501KT	C0G	220pF	±5%	500V	0.95
37	CSA1210C0G221J102KT	C0G	220pF	±5%	1000V	0.95
38	CSA1210C0G221J202MT	C0G	220pF	±5%	2000V	1.45
39	CSA1210C0G271J251KT	C0G	270pF	±5%	250V	0.95
40	CSA1210C0G271J501KT	C0G	270pF	±5%	500V	0.95
41	CSA1210C0G271J102KT	C0G	270pF	±5%	1000V	0.95
42	CSA1210C0G331J251KT	C0G	330pF	±5%	250V	0.95
43	CSA1210C0G331J501KT	C0G	330pF	±5%	500V	0.95
44	CSA1210C0G331J102KT	C0G	330pF	±5%	1000V	0.95
45	CSA1210C0G391J251KT	C0G	390pF	±5%	250V	0.95
46	CSA1210C0G391J501KT	C0G	390pF	±5%	500V	0.95
47	CSA1210C0G391J102KT	C0G	390pF	±5%	1000V	0.95
48	CSA1210C0G471J251KT	C0G	470pF	±5%	250V	0.95
49	CSA1210C0G471J501KT	C0G	470pF	±5%	500V	0.95
50	CSA1210C0G471J102KT	C0G	470pF	±5%	1000V	0.95

## C0G系列料号表

尺寸: 1210(公制: 3.2mmx2.5mm)

序号	HRE料号	材质	容值	容差	耐压	最大厚度 (mm)
51	CSA1210C0G561J251KT	C0G	560pF	±5%	250V	0.95
52	CSA1210C0G561J501KT	C0G	560pF	±5%	500V	0.95
53	CSA1210C0G561J102MT	C0G	560pF	±5%	1000V	1.45
54	CSA1210C0G681J251KT	C0G	680pF	±5%	250V	0.95
55	CSA1210C0G681J501KT	C0G	680pF	±5%	500V	0.95
56	CSA1210C0G681J102MT	C0G	680pF	±5%	1000V	1.45
57	CSA1210C0G821J251KT	C0G	820pF	±5%	250V	0.95
58	CSA1210C0G821J501KT	C0G	820pF	±5%	500V	0.95
59	CSA1210C0G821J102MT	C0G	820pF	±5%	1000V	1.45
60	CSA1210C0G102J251KT	C0G	1.0nF	±5%	250V	0.95
61	CSA1210C0G102J501KT	C0G	1.0nF	±5%	500V	0.95
62	CSA1210C0G102J102MT	C0G	1.0nF	±5%	1000V	1.45
63	CSA1210C0G152J251KT	C0G	1.5nF	±5%	250V	0.95
64	CSA1210C0G152J501KT	C0G	1.5nF	±5%	500V	0.95
65	CSA1210C0G182J251KT	C0G	1.8nF	±5%	250V	0.95
66	CSA1210C0G182J501KT	C0G	1.8nF	±5%	500V	0.95
67	CSA1210C0G222J251KT	C0G	2.2nF	±5%	250V	0.95
68	CSA1210C0G222J501KT	C0G	2.2nF	±5%	500V	0.95
69	CSA1210C0G272J251KT	C0G	2.7nF	±5%	250V	0.95
70	CSA1210C0G272J501MT	C0G	2.7nF	±5%	500V	1.45
71	CSA1210C0G332J251KT	C0G	3.3nF	±5%	250V	0.95
72	CSA1210C0G472J251KT	C0G	4.7nF	±5%	250V	0.95
73	CSA1210C0G103J500KT	C0G	10nF	±5%	50V	1.45
74	CSA1210C0G113J500KT	C0G	11nF	±5%	50V	1.80

## X7R系列料号表

尺寸: 01005(公制: 0.4mmx0.2mm)

序号	HRE料号	材质	容值	容差	耐压	最大厚度 (mm)
1	CSA01R5X7R101K100DT	X7R	100pF	±10%	10V	0.22
2	CSA01R5X7R121K100DT	X7R	120pF	±10%	10V	0.22
3	CSA01R5X7R221K100DT	X7R	220pF	±10%	10V	0.22
4	CSA01R5X7R331K100DT	X7R	330pF	±10%	10V	0.22
5	CSA01R5X7R331K160DT	X7R	330pF	±10%	16V	0.22
6	CSA01R5X7R471K100DT	X7R	470pF	±10%	10V	0.22
7	CSA01R5X7R102K100DT	X7R	1.0nF	±10%	10V	0.22

尺寸: 0201(公制: 0.6mmx0.3mm)

序号	HRE料号	材质	容值	容差	耐压	最大厚度 (mm)
1	CSA0201X7R151K160ET	X7R	150pF	±10%	16V	0.33
2	CSA0201X7R151K250ET	X7R	150pF	±10%	25V	0.33
3	CSA0201X7R181K250ET	X7R	180pF	±10%	25V	0.33
4	CSA0201X7R181K500ET	X7R	180pF	±10%	50V	0.33
5	CSA0201X7R221K160ET	X7R	220pF	±10%	16V	0.33
6	CSA0201X7R221K250ET	X7R	220pF	±10%	25V	0.33
7	CSA0201X7R221K500ET	X7R	220pF	±10%	50V	0.33
8	CSA0201X7R271K160ET	X7R	270pF	±10%	16V	0.33
9	CSA0201X7R271K250ET	X7R	270pF	±10%	25V	0.33
10	CSA0201X7R271K500ET	X7R	270pF	±10%	50V	0.33
11	CSA0201X7R331K250ET	X7R	330pF	±10%	25V	0.33
12	CSA0201X7R331K500ET	X7R	330pF	±10%	50V	0.33
13	CSA0201X7R471K160ET	X7R	470pF	±10%	16V	0.33
14	CSA0201X7R471K250ET	X7R	470pF	±10%	25V	0.33
15	CSA0201X7R471K500ET	X7R	470pF	±10%	50V	0.33
16	CSA0201X7R561K160ET	X7R	560pF	±10%	16V	0.33
17	CSA0201X7R681K250ET	X7R	680pF	±10%	25V	0.33
18	CSA0201X7R681K500ET	X7R	680pF	±10%	50V	0.33
19	CSA0201X7R751K500ET	X7R	750pF	±10%	50V	0.33
20	CSA0201X7R821K160ET	X7R	820pF	±10%	16V	0.33
21	CSA0201X7R102K160ET	X7R	1.0nF	±10%	16V	0.33
22	CSA0201X7R102K250ET	X7R	1.0nF	±10%	25V	0.33
23	CSA0201X7R102K500ET	X7R	1.0nF	±10%	50V	0.33
24	CSA0201X7R152K100ET	X7R	1.5nF	±10%	10V	0.33



## X7R系列料号表

尺寸: 0201(公制: 0.6mmx0.3mm)

序号	HRE料号	材质	容值	容差	耐压	最大厚度 (mm)
25	CSA0201X7R152K250ET	X7R	1.5nF	±10%	25V	0.33
26	CSA0201X7R152K500ET	X7R	1.5nF	±10%	50V	0.33
27	CSA0201X7R222K250ET	X7R	2.2nF	±10%	25V	0.33
28	CSA0201X7R222K500ET	X7R	2.2nF	±10%	50V	0.33
29	CSA0201X7R332K100ET	X7R	3.3nF	±10%	10V	0.33
30	CSA0201X7R332K250ET	X7R	3.3nF	±10%	25V	0.33
31	CSA0201X7R332K500ET	X7R	3.3nF	±10%	50V	0.33
32	CSA0201X7R472K6R3ET	X7R	4.7nF	±10%	6.3V	0.33
33	CSA0201X7R472K250ET	X7R	4.7nF	±10%	25V	0.33
34	CSA0201X7R472K500ET	X7R	4.7nF	±10%	50V	0.33
35	CSA0201X7R682K100ET	X7R	6.8nF	±10%	10V	0.33
36	CSA0201X7R682K250ET	X7R	6.8nF	±10%	25V	0.33
37	CSA0201X7R682K500ET	X7R	6.8nF	±10%	50V	0.33
38	CSA0201X7R103K6R3ET	X7R	10nF	±10%	6.3V	0.33
39	CSA0201X7R103K100ET	X7R	10nF	±10%	10V	0.33
40	CSA0201X7R103K250ET	X7R	10nF	±10%	25V	0.33

尺寸: 0402(公制: 1.0mmx0.5mm)

序号	HRE料号	材质	容值	容差	耐压	最大厚度 (mm)
1	CSA0402X7R181K500GT	X7R	180pF	±10%	50V	0.60
2	CSA0402X7R201K500GT	X7R	200pF	±10%	50V	0.60
3	CSA0402X7R221K500GT	X7R	220pF	±10%	50V	0.60
4	CSA0402X7R271K500GT	X7R	270pF	±10%	50V	0.60
5	CSA0402X7R331K500GT	X7R	330pF	±10%	50V	0.60
6	CSA0402X7R391K500GT	X7R	390pF	±10%	50V	0.60
7	CSA0402X7R471K500GT	X7R	470pF	±10%	50V	0.60
8	CSA0402X7R561K250GT	X7R	560pF	±10%	25V	0.60
9	CSA0402X7R561K500GT	X7R	560pF	±10%	50V	0.60
10	CSA0402X7R681K250GT	X7R	680pF	±10%	25V	0.60
11	CSA0402X7R681K500GT	X7R	680pF	±10%	50V	0.60
12	CSA0402X7R821K160GT	X7R	820pF	±10%	16V	0.60
13	CSA0402X7R821K250GT	X7R	820pF	±10%	25V	0.60
14	CSA0402X7R821K500GT	X7R	820pF	±10%	50V	0.60

## X7R系列料号表

尺寸: 0402(公制: 1.0mmx0.5mm)

序号	HRE料号	材质	容值	容差	耐压	最大厚度 (mm)
15	CSA0402X7R102K160GT	X7R	1.0nF	±10%	16V	0.60
16	CSA0402X7R102K250GT	X7R	1.0nF	±10%	25V	0.60
17	CSA0402X7R102K500GT	X7R	1.0nF	±10%	50V	0.60
18	CSA0402X7R152K160GT	X7R	1.5nF	±10%	16V	0.60
19	CSA0402X7R152K250GT	X7R	1.5nF	±10%	25V	0.60
20	CSA0402X7R152K500GT	X7R	1.5nF	±10%	50V	0.60
21	CSA0402X7R182K160GT	X7R	1.8nF	±10%	16V	0.60
22	CSA0402X7R182K250GT	X7R	1.8nF	±10%	25V	0.60
23	CSA0402X7R182K500GT	X7R	1.8nF	±10%	50V	0.60
24	CSA0402X7R222K160GT	X7R	2.2nF	±10%	16V	0.60
25	CSA0402X7R222K250GT	X7R	2.2nF	±10%	25V	0.60
26	CSA0402X7R222K500GT	X7R	2.2nF	±10%	50V	0.60
27	CSA0402X7R272K160GT	X7R	2.7nF	±10%	16V	0.60
28	CSA0402X7R272K250GT	X7R	2.7nF	±10%	25V	0.60
29	CSA0402X7R272K500GT	X7R	2.7nF	±10%	50V	0.60
30	CSA0402X7R332K160GT	X7R	3.3nF	±10%	16V	0.60
31	CSA0402X7R332K250GT	X7R	3.3nF	±10%	25V	0.60
32	CSA0402X7R332K500GT	X7R	3.3nF	±10%	50V	0.60
33	CSA0402X7R392K500GT	X7R	3.9nF	±10%	50V	0.60
34	CSA0402X7R472K160GT	X7R	4.7nF	±10%	16V	0.60
35	CSA0402X7R472K250GT	X7R	4.7nF	±10%	25V	0.60
36	CSA0402X7R472K500GT	X7R	4.7nF	±10%	50V	0.60
37	CSA0402X7R562K160GT	X7R	5.6nF	±10%	16V	0.60
38	CSA0402X7R562K250GT	X7R	5.6nF	±10%	25V	0.60
39	CSA0402X7R562K500GT	X7R	5.6nF	±10%	50V	0.60
40	CSA0402X7R682K500GT	X7R	6.8nF	±10%	50V	0.60
41	CSA0402X7R822K500GT	X7R	8.2nF	±10%	50V	0.60
42	CSA0402X7R103K160GT	X7R	10nF	±10%	16V	0.60
43	CSA0402X7R103K250GT	X7R	10nF	±10%	25V	0.60
44	CSA0402X7R103K500GT	X7R	10nF	±10%	50V	0.60
45	CSA0402X7R153K160GT	X7R	15nF	±10%	16V	0.60
46	CSA0402X7R153K250GT	X7R	15nF	±10%	25V	0.60
47	CSA0402X7R153K500GT	X7R	15nF	±10%	50V	0.60
48	CSA0402X7R183K160GT	X7R	18nF	±10%	16V	0.60
49	CSA0402X7R183K250GT	X7R	18nF	±10%	25V	0.60
50	CSA0402X7R223K100GT	X7R	22nF	±10%	10V	0.60

## X7R系列料号表

尺寸: 0402(公制: 1.0mmx0.5mm)

序号	HRE料号	材质	容值	容差	耐压	最大厚度 (mm)
51	CSA0402X7R223K160GT	X7R	22nF	±10%	16V	0.60
52	CSA0402X7R223K250GT	X7R	22nF	±10%	25V	0.60
53	CSA0402X7R223K500GT	X7R	22nF	±10%	50V	0.60
54	CSA0402X7R273K100GT	X7R	27nF	±10%	10V	0.60
55	CSA0402X7R273K160GT	X7R	27nF	±10%	16V	0.60
56	CSA0402X7R273K250GT	X7R	27nF	±10%	25V	0.60
57	CSA0402X7R333K100GT	X7R	33nF	±10%	10V	0.60
58	CSA0402X7R333K160GT	X7R	33nF	±10%	16V	0.60
59	CSA0402X7R333K250GT	X7R	33nF	±10%	25V	0.60
60	CSA0402X7R393K100GT	X7R	39nF	±10%	10V	0.60
61	CSA0402X7R393K160GT	X7R	39nF	±10%	16V	0.60
62	CSA0402X7R393K250GT	X7R	39nF	±10%	25V	0.60
63	CSA0402X7R473K100GT	X7R	47nF	±10%	10V	0.60
64	CSA0402X7R473K160GT	X7R	47nF	±10%	16V	0.60
65	CSA0402X7R473K250GT	X7R	47nF	±10%	25V	0.60
66	CSA0402X7R563K100GT	X7R	56nF	±10%	10V	0.60
67	CSA0402X7R563K160GT	X7R	56nF	±10%	16V	0.60
68	CSA0402X7R563K250GT	X7R	56nF	±10%	25V	0.60
69	CSA0402X7R683K100GT	X7R	68nF	±10%	10V	0.60
70	CSA0402X7R683K160GT	X7R	68nF	±10%	16V	0.60
71	CSA0402X7R683K250GT	X7R	68nF	±10%	25V	0.60
72	CSA0402X7R104K6R3GT	X7R	100nF	±10%	6.3V	0.60
73	CSA0402X7R104K100GT	X7R	100nF	±10%	10V	0.60
74	CSA0402X7R104K160GT	X7R	100nF	±10%	16V	0.60
75	CSA0402X7R104K250GT	X7R	100nF	±10%	25V	0.60
76	CSA0402X7R104K500GT	X7R	100nF	±10%	50V	0.60
77	CSA0402X7R154K6R3GT	X7R	150nF	±10%	6.3V	0.60
78	CSA0402X7R154K100GT	X7R	150nF	±10%	10V	0.60
79	CSA0402X7R154K160GT	X7R	150nF	±10%	16V	0.60
80	CSA0402X7R184K6R3GT	X7R	180nF	±10%	6.3V	0.60
81	CSA0402X7R184K100GT	X7R	180nF	±10%	10V	0.60
82	CSA0402X7R224K6R3GT	X7R	220nF	±10%	6.3V	0.60
83	CSA0402X7R224K100GT	X7R	220nF	±10%	10V	0.60
84	CSA0402X7R224K160GT	X7R	220nF	±10%	16V	0.60
85	CSA0402X7R274K6R3GT	X7R	270nF	±10%	6.3V	0.60
86	CSA0402X7R334K6R3GT	X7R	330nF	±10%	6.3V	0.60

## X7R系列料号表

尺寸: 0402(公制: 1.0mmx0.5mm)

序号	HRE料号	材质	容值	容差	耐压	最大厚度 (mm)
87	CSA0402X7R474K6R3GT	X7R	470nF	±10%	6.3V	0.60
88	CSA0402X7R474K100GT	X7R	470nF	±10%	10V	0.60

尺寸: 0603(公制: 1.6mmx0.8mm)

序号	HRE料号	材质	容值	容差	耐压	最大厚度 (mm)
1	CSA0603X7R101K500JT	X7R	100pF	±10%	50V	0.90
2	CSA0603X7R101K201JT	X7R	100pF	±10%	200V	0.90
3	CSA0603X7R101K251JT	X7R	100pF	±10%	250V	0.90
4	CSA0603X7R121K500JT	X7R	120pF	±10%	50V	0.90
5	CSA0603X7R121K201JT	X7R	120pF	±10%	200V	0.90
6	CSA0603X7R121K251JT	X7R	120pF	±10%	250V	0.90
7	CSA0603X7R151K500JT	X7R	150pF	±10%	50V	0.90
8	CSA0603X7R151K201JT	X7R	150pF	±10%	200V	0.90
9	CSA0603X7R151K251JT	X7R	150pF	±10%	250V	0.90
10	CSA0603X7R181K201JT	X7R	180pF	±10%	200V	0.90
11	CSA0603X7R181K251JT	X7R	180pF	±10%	250V	0.90
12	CSA0603X7R201K500JT	X7R	200pF	±10%	50V	0.90
13	CSA0603X7R201K201JT	X7R	200pF	±10%	200V	0.90
14	CSA0603X7R201K251JT	X7R	200pF	±10%	250V	0.90
15	CSA0603X7R221K500JT	X7R	220pF	±10%	50V	0.90
16	CSA0603X7R221K201JT	X7R	220pF	±10%	200V	0.90
17	CSA0603X7R221K251JT	X7R	220pF	±10%	250V	0.90
18	CSA0603X7R271K500JT	X7R	270pF	±10%	50V	0.90
19	CSA0603X7R271K201JT	X7R	270pF	±10%	200V	0.90
20	CSA0603X7R271K251JT	X7R	270pF	±10%	250V	0.90
21	CSA0603X7R331K500JT	X7R	330pF	±10%	50V	0.90
22	CSA0603X7R331K201JT	X7R	330pF	±10%	200V	0.90
23	CSA0603X7R331K251JT	X7R	330pF	±10%	250V	0.90
24	CSA0603X7R391K500JT	X7R	390pF	±10%	50V	0.90
25	CSA0603X7R391K201JT	X7R	390pF	±10%	200V	0.90
26	CSA0603X7R391K251JT	X7R	390pF	±10%	250V	0.90
27	CSA0603X7R471K500JT	X7R	470pF	±10%	50V	0.90
28	CSA0603X7R471K201JT	X7R	470pF	±10%	200V	0.90
29	CSA0603X7R471K251JT	X7R	470pF	±10%	250V	0.90
30	CSA0603X7R511K500JT	X7R	510pF	±10%	50V	0.90

## X7R系列料号表

尺寸: 0603(公制: 1.6mmx0.8mm)

序号	HRE料号	材质	容值	容差	耐压	最大厚度 (mm)
31	CSA0603X7R561K500JT	X7R	560pF	±10%	50V	0.90
32	CSA0603X7R561K201JT	X7R	560pF	±10%	200V	0.90
33	CSA0603X7R561K251JT	X7R	560pF	±10%	250V	0.90
34	CSA0603X7R681K500JT	X7R	680pF	±10%	50V	0.90
35	CSA0603X7R681K201JT	X7R	680pF	±10%	200V	0.90
36	CSA0603X7R681K251JT	X7R	680pF	±10%	250V	0.90
37	CSA0603X7R821K500JT	X7R	820pF	±10%	50V	0.90
38	CSA0603X7R821K201JT	X7R	820pF	±10%	200V	0.90
39	CSA0603X7R821K251JT	X7R	820pF	±10%	250V	0.90
40	CSA0603X7R102K500JT	X7R	1.0nF	±10%	50V	0.90
41	CSA0603X7R102K101JT	X7R	1.0nF	±10%	100V	0.90
42	CSA0603X7R102K201JT	X7R	1.0nF	±10%	200V	0.90
43	CSA0603X7R102K251JT	X7R	1.0nF	±10%	250V	0.90
44	CSA0603X7R122K500JT	X7R	1.2nF	±10%	50V	0.90
45	CSA0603X7R152K500JT	X7R	1.5nF	±10%	50V	0.90
46	CSA0603X7R152K101JT	X7R	1.5nF	±10%	100V	0.90
47	CSA0603X7R152K201JT	X7R	1.5nF	±10%	200V	0.90
48	CSA0603X7R152K251JT	X7R	1.5nF	±10%	250V	0.90
49	CSA0603X7R182K500JT	X7R	1.8nF	±10%	50V	0.90
50	CSA0603X7R182K101JT	X7R	1.8nF	±10%	100V	0.90
51	CSA0603X7R182K201JT	X7R	1.8nF	±10%	200V	0.90
52	CSA0603X7R182K251JT	X7R	1.8nF	±10%	250V	0.90
53	CSA0603X7R222K500JT	X7R	2.2nF	±10%	50V	0.90
54	CSA0603X7R222K101JT	X7R	2.2nF	±10%	100V	0.90
55	CSA0603X7R222K201JT	X7R	2.2nF	±10%	200V	0.90
56	CSA0603X7R222K251JT	X7R	2.2nF	±10%	250V	0.90
57	CSA0603X7R272K500JT	X7R	2.7nF	±10%	50V	0.90
58	CSA0603X7R272K101JT	X7R	2.7nF	±10%	100V	0.90
59	CSA0603X7R272K201JT	X7R	2.7nF	±10%	200V	0.90
60	CSA0603X7R272K251JT	X7R	2.7nF	±10%	250V	0.90
61	CSA0603X7R332K500JT	X7R	3.3nF	±10%	50V	0.90
62	CSA0603X7R332K101JT	X7R	3.3nF	±10%	100V	0.90
63	CSA0603X7R332K201JT	X7R	3.3nF	±10%	200V	0.90
64	CSA0603X7R332K251JT	X7R	3.3nF	±10%	250V	0.90
65	CSA0603X7R392K500JT	X7R	3.9nF	±10%	50V	0.90
66	CSA0603X7R472K250JT	X7R	4.7nF	±10%	25V	0.90

## X7R系列料号表

尺寸: 0603(公制: 1.6mmx0.8mm)

序号	HRE料号	材质	容值	容差	耐压	最大厚度 (mm)
67	CSA0603X7R472K500JT	X7R	4.7nF	±10%	50V	0.90
68	CSA0603X7R472K101JT	X7R	4.7nF	±10%	100V	0.90
69	CSA0603X7R472K201JT	X7R	4.7nF	±10%	200V	0.90
70	CSA0603X7R472K251JT	X7R	4.7nF	±10%	250V	0.90
71	CSA0603X7R562K250JT	X7R	5.6nF	±10%	25V	0.90
72	CSA0603X7R562K500JT	X7R	5.6nF	±10%	50V	0.90
73	CSA0603X7R562K101JT	X7R	5.6nF	±10%	100V	0.90
74	CSA0603X7R562K201JT	X7R	5.6nF	±10%	200V	0.90
75	CSA0603X7R562K251JT	X7R	5.6nF	±10%	250V	0.90
76	CSA0603X7R682K250JT	X7R	6.8nF	±10%	25V	0.90
77	CSA0603X7R682K500JT	X7R	6.8nF	±10%	50V	0.90
78	CSA0603X7R682K101JT	X7R	6.8nF	±10%	100V	0.90
79	CSA0603X7R682K201JT	X7R	6.8nF	±10%	200V	0.90
80	CSA0603X7R682K251JT	X7R	6.8nF	±10%	250V	0.90
81	CSA0603X7R822K500JT	X7R	8.2nF	±10%	50V	0.90
82	CSA0603X7R103K6R3JT	X7R	10nF	±10%	6.3V	0.90
83	CSA0603X7R103K100JT	X7R	10nF	±10%	10V	0.90
84	CSA0603X7R103K160JT	X7R	10nF	±10%	16V	0.90
85	CSA0603X7R103K250JT	X7R	10nF	±10%	25V	0.90
86	CSA0603X7R103K500JT	X7R	10nF	±10%	50V	0.90
87	CSA0603X7R103K101JT	X7R	10nF	±10%	100V	0.90
88	CSA0603X7R123K500JT	X7R	12nF	±10%	50V	0.90
89	CSA0603X7R153K6R3JT	X7R	15nF	±10%	6.3V	0.90
90	CSA0603X7R153K100JT	X7R	15nF	±10%	10V	0.90
91	CSA0603X7R153K160JT	X7R	15nF	±10%	16V	0.90
92	CSA0603X7R153K250JT	X7R	15nF	±10%	25V	0.90
93	CSA0603X7R153K500JT	X7R	15nF	±10%	50V	0.90
94	CSA0603X7R153K101JT	X7R	15nF	±10%	100V	0.90
95	CSA0603X7R183K6R3JT	X7R	18nF	±10%	6.3V	0.90
96	CSA0603X7R183K100JT	X7R	18nF	±10%	10V	0.90
97	CSA0603X7R183K160JT	X7R	18nF	±10%	16V	0.90
98	CSA0603X7R183K250JT	X7R	18nF	±10%	25V	0.90
99	CSA0603X7R183K500JT	X7R	18nF	±10%	50V	0.90
100	CSA0603X7R183K101JT	X7R	18nF	±10%	100V	0.90
101	CSA0603X7R203K500JT	X7R	20nF	±10%	50V	0.90
102	CSA0603X7R223K6R3JT	X7R	22nF	±10%	6.3V	0.90

## X7R系列料号表

尺寸: 0603(公制: 1.6mmx0.8mm)

序号	HRE料号	材质	容值	容差	耐压	最大厚度 (mm)
103	CSA0603X7R223K100JT	X7R	22nF	±10%	10V	0.90
104	CSA0603X7R223K160JT	X7R	22nF	±10%	16V	0.90
105	CSA0603X7R223K250JT	X7R	22nF	±10%	25V	0.90
106	CSA0603X7R223K500JT	X7R	22nF	±10%	50V	0.90
107	CSA0603X7R223K101JT	X7R	22nF	±10%	100V	0.90
108	CSA0603X7R273K6R3JT	X7R	27nF	±10%	6.3V	0.90
109	CSA0603X7R273K100JT	X7R	27nF	±10%	10V	0.90
110	CSA0603X7R273K160JT	X7R	27nF	±10%	16V	0.90
111	CSA0603X7R273K250JT	X7R	27nF	±10%	25V	0.90
112	CSA0603X7R273K500JT	X7R	27nF	±10%	50V	0.90
113	CSA0603X7R333K6R3JT	X7R	33nF	±10%	6.3V	0.90
114	CSA0603X7R333K100JT	X7R	33nF	±10%	10V	0.90
115	CSA0603X7R333K160JT	X7R	33nF	±10%	16V	0.90
116	CSA0603X7R333K250JT	X7R	33nF	±10%	25V	0.90
117	CSA0603X7R333K500JT	X7R	33nF	±10%	50V	1.00
118	CSA0603X7R393K6R3JT	X7R	39nF	±10%	6.3V	0.90
119	CSA0603X7R393K100JT	X7R	39nF	±10%	10V	0.90
120	CSA0603X7R393K160JT	X7R	39nF	±10%	16V	0.90
121	CSA0603X7R393K250JT	X7R	39nF	±10%	25V	0.90
122	CSA0603X7R393K500JT	X7R	39nF	±10%	50V	1.00
123	CSA0603X7R473K6R3JT	X7R	47nF	±10%	6.3V	0.90
124	CSA0603X7R473K100JT	X7R	47nF	±10%	10V	0.90
125	CSA0603X7R473K160JT	X7R	47nF	±10%	16V	0.90
126	CSA0603X7R473K250JT	X7R	47nF	±10%	25V	0.90
127	CSA0603X7R473K500JT	X7R	47nF	±10%	50V	1.00
128	CSA0603X7R563K6R3JT	X7R	56nF	±10%	6.3V	0.90
129	CSA0603X7R563K100JT	X7R	56nF	±10%	10V	0.90
130	CSA0603X7R563K160JT	X7R	56nF	±10%	16V	0.90
131	CSA0603X7R563K250JT	X7R	56nF	±10%	25V	0.90
132	CSA0603X7R563K500JT	X7R	56nF	±10%	50V	1.00
133	CSA0603X7R683K6R3JT	X7R	68nF	±10%	6.3V	0.90
134	CSA0603X7R683K100JT	X7R	68nF	±10%	10V	0.90
135	CSA0603X7R683K160JT	X7R	68nF	±10%	16V	0.90
136	CSA0603X7R683K250JT	X7R	68nF	±10%	25V	0.90
137	CSA0603X7R683K500JT	X7R	68nF	±10%	50V	1.00
138	CSA0603X7R823K500JT	X7R	82nF	±10%	50V	1.00

## X7R系列料号表

尺寸: 0603(公制: 1.6mmx0.8mm)

序号	HRE料号	材质	容值	容差	耐压	最大厚度 (mm)
139	CSA0603X7R104K6R3JT	X7R	100nF	±10%	6.3V	0.90
140	CSA0603X7R104K100JT	X7R	100nF	±10%	10V	0.90
141	CSA0603X7R104K160JT	X7R	100nF	±10%	16V	0.90
142	CSA0603X7R104K250JT	X7R	100nF	±10%	25V	0.90
143	CSA0603X7R104K500JT	X7R	100nF	±10%	50V	1.00
144	CSA0603X7R104K101JT	X7R	100nF	±10%	100V	0.90
145	CSA0603X7R154K6R3JT	X7R	150nF	±10%	6.3V	1.00
146	CSA0603X7R154K100JT	X7R	150nF	±10%	10V	1.00
147	CSA0603X7R154K160JT	X7R	150nF	±10%	16V	0.90
148	CSA0603X7R154K250JT	X7R	150nF	±10%	25V	1.00
149	CSA0603X7R154K500JT	X7R	150nF	±10%	50V	1.00
150	CSA0603X7R184K6R3JT	X7R	180nF	±10%	6.3V	1.00
151	CSA0603X7R184K100JT	X7R	180nF	±10%	10V	1.00
152	CSA0603X7R184K160JT	X7R	180nF	±10%	16V	0.90
153	CSA0603X7R184K250JT	X7R	180nF	±10%	25V	1.00
154	CSA0603X7R184K500JT	X7R	180nF	±10%	50V	1.00
155	CSA0603X7R224K6R3JT	X7R	220nF	±10%	6.3V	1.00
156	CSA0603X7R224K100JT	X7R	220nF	±10%	10V	1.00
157	CSA0603X7R224K160JT	X7R	220nF	±10%	16V	1.00
158	CSA0603X7R224K250JT	X7R	220nF	±10%	25V	1.00
159	CSA0603X7R224K500JT	X7R	220nF	±10%	50V	1.00
160	CSA0603X7R274K6R3JT	X7R	270nF	±10%	6.3V	1.00
161	CSA0603X7R274K100JT	X7R	270nF	±10%	10V	1.00
162	CSA0603X7R274K160JT	X7R	270nF	±10%	16V	1.00
163	CSA0603X7R274K250JT	X7R	270nF	±10%	25V	1.00
164	CSA0603X7R274K500JT	X7R	270nF	±10%	50V	1.00
165	CSA0603X7R334K6R3JT	X7R	330nF	±10%	6.3V	1.00
166	CSA0603X7R334K100JT	X7R	330nF	±10%	10V	1.00
167	CSA0603X7R334K160JT	X7R	330nF	±10%	16V	1.00
168	CSA0603X7R334K250JT	X7R	330nF	±10%	25V	1.00
169	CSA0603X7R334K500JT	X7R	330nF	±10%	50V	1.00
170	CSA0603X7R474K6R3JT	X7R	470nF	±10%	6.3V	1.00
171	CSA0603X7R474K100JT	X7R	470nF	±10%	10V	1.00
172	CSA0603X7R474K160JT	X7R	470nF	±10%	16V	1.00
173	CSA0603X7R474K250JT	X7R	470nF	±10%	25V	1.00
174	CSA0603X7R474K500JT	X7R	470nF	±10%	50V	1.00



## X7R系列料号表

尺寸: 0603(公制: 1.6mmx0.8mm)

序号	HRE料号	材质	容值	容差	耐压	最大厚度 (mm)
175	CSA0603X7R684K6R3JT	X7R	680nF	±10%	6.3V	1.00
176	CSA0603X7R684K100JT	X7R	680nF	±10%	10V	1.00
177	CSA0603X7R684K160JT	X7R	680nF	±10%	16V	1.00
178	CSA0603X7R684K250JT	X7R	680nF	±10%	25V	1.00
179	CSA0603X7R684K500JT	X7R	680nF	±10%	50V	1.00
180	CSA0603X7R105K6R3JT	X7R	1.0uF	±10%	6.3V	1.00
181	CSA0603X7R105K100JT	X7R	1.0uF	±10%	10V	1.00
182	CSA0603X7R105K160JT	X7R	1.0uF	±10%	16V	1.00
183	CSA0603X7R105K250JT	X7R	1.0uF	±10%	25V	1.00
184	CSA0603X7R105K500JT	X7R	1.0uF	±10%	50V	1.00
185	CSA0603X7R225K6R3JT	X7R	2.2uF	±10%	6.3V	1.00
186	CSA0603X7R225K100JT	X7R	2.2uF	±10%	10V	1.00
187	CSA0603X7R475K6R3JT	X7R	4.7uF	±10%	6.3V	1.00
188	CSA0603X7R106K6R3JT	X7R	10uF	±20%	6.3V	1.00

尺寸: 0805(公制: 2.0mmx1.25mm)

序号	HRE料号	材质	容值	容差	耐压	最大厚度 (mm)
1	CSA0805X7R101K251HT	X7R	100pF	±10%	250V	0.70
2	CSA0805X7R121K251HT	X7R	120pF	±10%	250V	0.70
3	CSA0805X7R151K251HT	X7R	150pF	±10%	250V	0.70
4	CSA0805X7R181K500KT	X7R	180pF	±10%	50V	0.95
5	CSA0805X7R181K101HT	X7R	180pF	±10%	100V	0.70
6	CSA0805X7R181K251HT	X7R	180pF	±10%	250V	0.70
7	CSA0805X7R201K500KT	X7R	200pF	±10%	50V	0.95
8	CSA0805X7R201K101HT	X7R	200pF	±10%	100V	0.70
9	CSA0805X7R201K251HT	X7R	200pF	±10%	250V	0.70
10	CSA0805X7R221K500KT	X7R	220pF	±10%	50V	0.95
11	CSA0805X7R221K101KT	X7R	220pF	±10%	100V	0.95
12	CSA0805X7R221K201KT	X7R	220pF	±10%	200V	0.95
13	CSA0805X7R221K251KT	X7R	220pF	±10%	250V	0.95
14	CSA0805X7R271K101KT	X7R	270pF	±10%	100V	0.95
15	CSA0805X7R271K251KT	X7R	270pF	±10%	250V	0.95
16	CSA0805X7R301K500KT	X7R	300pF	±10%	50V	0.95
17	CSA0805X7R331K500KT	X7R	330pF	±10%	50V	0.95
18	CSA0805X7R331K101MT	X7R	330pF	±10%	100V	1.45

## X7R系列料号表

尺寸: 0805(公制: 2.0mmx1.25mm)

序号	HRE料号	材质	容值	容差	耐压	最大厚度 (mm)
19	CSA0805X7R331K251MT	X7R	330pF	±10%	250V	1.45
20	CSA0805X7R391K500KT	X7R	390pF	±10%	50V	0.95
21	CSA0805X7R391K101MT	X7R	390pF	±10%	100V	1.45
22	CSA0805X7R391K251MT	X7R	390pF	±10%	250V	1.45
23	CSA0805X7R471K500KT	X7R	470pF	±10%	50V	0.95
24	CSA0805X7R471K101MT	X7R	470pF	±10%	100V	1.45
25	CSA0805X7R471K201MT	X7R	470pF	±10%	200V	0.95
26	CSA0805X7R471K251MT	X7R	470pF	±10%	250V	1.45
27	CSA0805X7R511K500KT	X7R	510pF	±10%	50V	0.95
28	CSA0805X7R561K101MT	X7R	560pF	±10%	100V	1.45
29	CSA0805X7R561K251MT	X7R	560pF	±10%	250V	1.45
30	CSA0805X7R681K500KT	X7R	680pF	±10%	50V	0.95
31	CSA0805X7R681K101MT	X7R	680pF	±10%	100V	1.45
32	CSA0805X7R681K251MT	X7R	680pF	±10%	250V	1.45
33	CSA0805X7R821K500KT	X7R	820pF	±10%	50V	0.95
34	CSA0805X7R821K101MT	X7R	820pF	±10%	100V	1.45
35	CSA0805X7R821K251MT	X7R	820pF	±10%	250V	1.45
36	CSA0805X7R102K250KT	X7R	1.0nF	±10%	25V	0.95
37	CSA0805X7R102K500KT	X7R	1.0nF	±10%	50V	0.95
38	CSA0805X7R102K101MT	X7R	1.0nF	±10%	100V	1.45
39	CSA0805X7R102K201MT	X7R	1.0nF	±10%	200V	1.45
40	CSA0805X7R102K251MT	X7R	1.0nF	±10%	250V	1.45
41	CSA0805X7R152K250KT	X7R	1.5nF	±10%	25V	0.95
42	CSA0805X7R152K500KT	X7R	1.5nF	±10%	50V	0.95
43	CSA0805X7R152K101MT	X7R	1.5nF	±10%	100V	1.45
44	CSA0805X7R152K251MT	X7R	1.5nF	±10%	250V	1.45
45	CSA0805X7R182K250KT	X7R	1.8nF	±10%	25V	0.95
46	CSA0805X7R182K500KT	X7R	1.8nF	±10%	50V	0.95
47	CSA0805X7R182K101MT	X7R	1.8nF	±10%	100V	1.45
48	CSA0805X7R182K251MT	X7R	1.8nF	±10%	250V	1.45
49	CSA0805X7R222K250KT	X7R	2.2nF	±10%	25V	0.95
50	CSA0805X7R222K500KT	X7R	2.2nF	±10%	50V	0.95
51	CSA0805X7R222K101MT	X7R	2.2nF	±10%	100V	1.45
52	CSA0805X7R222K201MT	X7R	2.2nF	±10%	200V	1.45
53	CSA0805X7R222K251MT	X7R	2.2nF	±10%	250V	1.45
54	CSA0805X7R272K250KT	X7R	2.7nF	±10%	25V	0.95

## X7R系列料号表

尺寸: 0805(公制: 2.0mmx1.25mm)

序号	HRE料号	材质	容值	容差	耐压	最大厚度 (mm)
55	CSA0805X7R272K500KT	X7R	2.7nF	±10%	50V	0.95
56	CSA0805X7R272K101MT	X7R	2.7nF	±10%	100V	1.45
57	CSA0805X7R272K251MT	X7R	2.7nF	±10%	250V	1.45
58	CSA0805X7R332K250KT	X7R	3.3nF	±10%	25V	0.95
59	CSA0805X7R332K500KT	X7R	3.3nF	±10%	50V	0.95
60	CSA0805X7R332K101MT	X7R	3.3nF	±10%	100V	1.45
61	CSA0805X7R332K251MT	X7R	3.3nF	±10%	250V	1.45
62	CSA0805X7R472K250KT	X7R	4.7nF	±10%	25V	0.95
63	CSA0805X7R472K500KT	X7R	4.7nF	±10%	50V	0.95
64	CSA0805X7R472K101MT	X7R	4.7nF	±10%	100V	1.45
65	CSA0805X7R472K201MT	X7R	4.7nF	±10%	200V	1.45
66	CSA0805X7R472K251MT	X7R	4.7nF	±10%	250V	1.45
67	CSA0805X7R562K250KT	X7R	5.6nF	±10%	25V	0.95
68	CSA0805X7R562K500KT	X7R	5.6nF	±10%	50V	0.95
69	CSA0805X7R562K101MT	X7R	5.6nF	±10%	100V	1.45
70	CSA0805X7R562K251MT	X7R	5.6nF	±10%	250V	1.45
71	CSA0805X7R682K250KT	X7R	6.8nF	±10%	25V	0.95
72	CSA0805X7R682K500KT	X7R	6.8nF	±10%	50V	0.95
73	CSA0805X7R682K101MT	X7R	6.8nF	±10%	100V	1.45
74	CSA0805X7R682K251MT	X7R	6.8nF	±10%	250V	1.45
75	CSA0805X7R103K250KT	X7R	10nF	±10%	25V	0.95
76	CSA0805X7R103K500KT	X7R	10nF	±10%	50V	0.95
77	CSA0805X7R103K101MT	X7R	10nF	±10%	100V	1.45
78	CSA0805X7R103K201MT	X7R	10nF	±10%	200V	1.45
79	CSA0805X7R103K251MT	X7R	10nF	±10%	250V	1.45
80	CSA0805X7R153K250KT	X7R	15nF	±10%	25V	0.95
81	CSA0805X7R153K500KT	X7R	15nF	±10%	50V	0.95
82	CSA0805X7R153K101MT	X7R	15nF	±10%	100V	1.45
83	CSA0805X7R183K250KT	X7R	18nF	±10%	25V	0.95
84	CSA0805X7R183K500KT	X7R	18nF	±10%	50V	0.95
85	CSA0805X7R183K101MT	X7R	18nF	±10%	100V	1.45
86	CSA0805X7R223K250KT	X7R	22nF	±10%	25V	0.95
87	CSA0805X7R223K500KT	X7R	22nF	±10%	50V	0.95
88	CSA0805X7R223K101MT	X7R	22nF	±10%	100V	1.45
89	CSA0805X7R273K250KT	X7R	27nF	±10%	25V	0.95
90	CSA0805X7R273K500KT	X7R	27nF	±10%	50V	0.95

## X7R系列料号表

尺寸: 0805(公制: 2.0mmx1.25mm)

序号	HRE料号	材质	容值	容差	耐压	最大厚度 (mm)
91	CSA0805X7R273K101MT	X7R	27nF	±10%	100V	1.45
92	CSA0805X7R333K250KT	X7R	33nF	±10%	25V	0.95
93	CSA0805X7R333K500KT	X7R	33nF	±10%	50V	0.95
94	CSA0805X7R333K101MT	X7R	33nF	±10%	100V	1.45
95	CSA0805X7R393K250KT	X7R	39nF	±10%	25V	0.95
96	CSA0805X7R393K500KT	X7R	39nF	±10%	50V	0.95
97	CSA0805X7R393K101MT	X7R	39nF	±10%	100V	1.45
98	CSA0805X7R473K250KT	X7R	47nF	±10%	25V	0.95
99	CSA0805X7R473K500KT	X7R	47nF	±10%	50V	0.95
100	CSA0805X7R473K101MT	X7R	47nF	±10%	100V	1.45
101	CSA0805X7R563K250KT	X7R	56nF	±10%	25V	0.95
102	CSA0805X7R563K500KT	X7R	56nF	±10%	50V	0.95
103	CSA0805X7R563K101MT	X7R	56nF	±10%	100V	1.45
104	CSA0805X7R683K250KT	X7R	68nF	±10%	25V	0.95
105	CSA0805X7R683K500KT	X7R	68nF	±10%	50V	0.95
106	CSA0805X7R683K101MT	X7R	68nF	±10%	100V	1.45
107	CSA0805X7R104K160KT	X7R	100nF	±10%	16V	0.95
108	CSA0805X7R104K250KT	X7R	100nF	±10%	25V	0.95
109	CSA0805X7R104K500KT	X7R	100nF	±10%	50V	0.95
110	CSA0805X7R104K101MT	X7R	100nF	±10%	100V	1.45
111	CSA0805X7R154K160KT	X7R	150nF	±10%	16V	0.95
112	CSA0805X7R154K250KT	X7R	150nF	±10%	25V	0.95
113	CSA0805X7R154K500KT	X7R	150nF	±10%	50V	0.95
114	CSA0805X7R184K160KT	X7R	180nF	±10%	16V	0.95
115	CSA0805X7R184K250KT	X7R	180nF	±10%	25V	0.95
116	CSA0805X7R184K500KT	X7R	180nF	±10%	50V	0.95
117	CSA0805X7R224K160KT	X7R	220nF	±10%	16V	0.95
118	CSA0805X7R224K250KT	X7R	220nF	±10%	25V	0.95
119	CSA0805X7R224K500MT	X7R	220nF	±10%	50V	1.45
120	CSA0805X7R224K101MT	X7R	220nF	±10%	100V	1.45
121	CSA0805X7R274K160KT	X7R	270nF	±10%	16V	0.95
122	CSA0805X7R274K250KT	X7R	270nF	±10%	25V	0.95
123	CSA0805X7R274K500MT	X7R	270nF	±10%	50V	1.45
124	CSA0805X7R334K160KT	X7R	330nF	±10%	16V	0.95
125	CSA0805X7R334K250KT	X7R	330nF	±10%	25V	0.95
126	CSA0805X7R334K500MT	X7R	330nF	±10%	50V	1.45

## X7R系列料号表

尺寸: 0805(公制: 2.0mmx1.25mm)

序号	HRE料号	材质	容值	容差	耐压	最大厚度 (mm)
127	CSA0805X7R474K160MT	X7R	470nF	±10%	16V	1.45
128	CSA0805X7R474K250MT	X7R	470nF	±10%	25V	1.45
129	CSA0805X7R474K500MT	X7R	470nF	±10%	50V	1.45
130	CSA0805X7R684K6R3KT	X7R	680nF	±10%	6.3V	0.95
131	CSA0805X7R684K100KT	X7R	680nF	±10%	10V	0.95
132	CSA0805X7R684K160MT	X7R	680nF	±10%	16V	1.45
133	CSA0805X7R684K250MT	X7R	680nF	±10%	25V	1.45
134	CSA0805X7R684K500MT	X7R	680nF	±10%	50V	1.45
135	CSA0805X7R105K6R3KT	X7R	1.0uF	±10%	6.3V	0.95
136	CSA0805X7R105K100KT	X7R	1.0uF	±10%	10V	0.95
137	CSA0805X7R105K160MT	X7R	1.0uF	±10%	16V	1.45
138	CSA0805X7R105K250MT	X7R	1.0uF	±10%	25V	1.45
139	CSA0805X7R105K500MT	X7R	1.0uF	±10%	50V	1.45
140	CSA0805X7R225K6R3MT	X7R	2.2uF	±10%	6.3V	1.45
141	CSA0805X7R225K100MT	X7R	2.2uF	±10%	10V	1.45
142	CSA0805X7R225K160MT	X7R	2.2uF	±10%	16V	1.45
143	CSA0805X7R225K250MT	X7R	2.2uF	±10%	25V	1.45
144	CSA0805X7R475K6R3MT	X7R	4.7uF	±10%	6.3V	1.45
145	CSA0805X7R475K100MT	X7R	4.7uF	±10%	10V	1.45
146	CSA0805X7R475K160MT	X7R	4.7uF	±10%	16V	1.45
147	CSA0805X7R475K250MT	X7R	4.7uF	±10%	25V	1.45
148	CSA0805X7R106K6R3MT	X7R	10uF	±10%	6.3V	1.45
149	CSA0805X7R106K100MT	X7R	10uF	±10%	10V	1.45
150	CSA0805X7R106K160MT	X7R	10uF	±10%	16V	1.45

## X7R系列料号表

尺寸: 1206(公制: 3.2mmx1.6mm)

序号	HRE料号	材质	容值	容差	耐压	最大厚度 (mm)
1	CSA1206X7R101K102MT	X7R	100pF	±10%	1000V	1.45
2	CSA1206X7R101K202MT	X7R	100pF	±10%	2000V	1.45
3	CSA1206X7R121K102MT	X7R	120pF	±10%	1000V	1.45
4	CSA1206X7R121K202MT	X7R	120pF	±10%	2000V	1.45
5	CSA1206X7R151K102MT	X7R	150pF	±10%	1000V	1.45
6	CSA1206X7R151K202MT	X7R	150pF	±10%	2000V	1.45

## X7R系列料号表

尺寸: 1206(公制: 3.2mmx1.6mm)

序号	HRE料号	材质	容值	容差	耐压	最大厚度 (mm)
7	CSA1206X7R181K102MT	X7R	180pF	±10%	1000V	1.45
8	CSA1206X7R181K202MT	X7R	180pF	±10%	2000V	1.45
9	CSA1206X7R201K102MT	X7R	200pF	±10%	1000V	1.45
10	CSA1206X7R201K202MT	X7R	200pF	±10%	2000V	1.45
11	CSA1206X7R221K500KT	X7R	220pF	±10%	50V	0.95
12	CSA1206X7R221K501MT	X7R	220pF	±10%	500V	1.45
13	CSA1206X7R221K102MT	X7R	220pF	±10%	1000V	1.45
14	CSA1206X7R221K202MT	X7R	220pF	±10%	2000V	1.45
15	CSA1206X7R271K500KT	X7R	270pF	±10%	50V	0.95
16	CSA1206X7R271K501MT	X7R	270pF	±10%	500V	1.45
17	CSA1206X7R271K102MT	X7R	270pF	±10%	1000V	1.45
18	CSA1206X7R271K202MT	X7R	270pF	±10%	2000V	1.45
19	CSA1206X7R331K500KT	X7R	330pF	±10%	50V	0.95
20	CSA1206X7R331K501MT	X7R	330pF	±10%	500V	1.45
21	CSA1206X7R331K631MT	X7R	330pF	±10%	630V	1.45
22	CSA1206X7R331K102MT	X7R	330pF	±10%	1000V	1.45
23	CSA1206X7R331K202MT	X7R	330pF	±10%	2000V	1.45
24	CSA1206X7R391K500KT	X7R	390pF	±10%	50V	0.95
25	CSA1206X7R391K501MT	X7R	390pF	±10%	500V	1.45
26	CSA1206X7R391K631MT	X7R	390pF	±10%	630V	1.45
27	CSA1206X7R391K102MT	X7R	390pF	±10%	1000V	1.45
28	CSA1206X7R391K202MT	X7R	390pF	±10%	2000V	1.45
29	CSA1206X7R471K500KT	X7R	470pF	±10%	50V	0.95
30	CSA1206X7R471K201MT	X7R	470pF	±10%	200V	1.45
31	CSA1206X7R471K501MT	X7R	470pF	±10%	500V	1.45
32	CSA1206X7R471K631MT	X7R	470pF	±10%	630V	1.45
33	CSA1206X7R471K102MT	X7R	470pF	±10%	1000V	1.45
34	CSA1206X7R471K202MT	X7R	470pF	±10%	2000V	1.45
35	CSA1206X7R561K500KT	X7R	560pF	±10%	50V	0.95
36	CSA1206X7R561K501MT	X7R	560pF	±10%	500V	1.45
37	CSA1206X7R561K631MT	X7R	560pF	±10%	630V	1.45
38	CSA1206X7R561K102MT	X7R	560pF	±10%	1000V	1.45
39	CSA1206X7R561K202MT	X7R	560pF	±10%	2000V	1.45
40	CSA1206X7R681K500KT	X7R	680pF	±10%	50V	0.95
41	CSA1206X7R681K501MT	X7R	680pF	±10%	500V	1.45
42	CSA1206X7R681K631MT	X7R	680pF	±10%	630V	1.45

## X7R系列料号表

尺寸: 1206(公制: 3.2mmx1.6mm)

序号	HRE料号	材质	容值	容差	耐压	最大厚度 (mm)
43	CSA1206X7R681K102MT	X7R	680pF	±10%	1000V	1.45
44	CSA1206X7R681K202MT	X7R	680pF	±10%	2000V	1.45
45	CSA1206X7R821K500KT	X7R	820pF	±10%	50V	0.95
46	CSA1206X7R821K501MT	X7R	820pF	±10%	500V	1.45
47	CSA1206X7R821K631MT	X7R	820pF	±10%	630V	1.45
48	CSA1206X7R821K102MT	X7R	820pF	±10%	1000V	1.45
49	CSA1206X7R821K202MT	X7R	820pF	±10%	2000V	1.45
50	CSA1206X7R102K500KT	X7R	1.0nF	±10%	50V	0.95
51	CSA1206X7R102K201MT	X7R	1.0nF	±10%	200V	1.45
52	CSA1206X7R102K501MT	X7R	1.0nF	±10%	500V	1.45
53	CSA1206X7R102K631MT	X7R	1.0nF	±10%	630V	1.45
54	CSA1206X7R102K102MT	X7R	1.0nF	±10%	1000V	1.45
55	CSA1206X7R102K202MT	X7R	1.0nF	±10%	2000V	1.45
56	CSA1206X7R152K500KT	X7R	1.5nF	±10%	50V	0.95
57	CSA1206X7R152K501MT	X7R	1.5nF	±10%	500V	1.45
58	CSA1206X7R152K631MT	X7R	1.5nF	±10%	630V	1.45
59	CSA1206X7R152K102MT	X7R	1.5nF	±10%	1000V	1.45
60	CSA1206X7R182K500KT	X7R	1.8nF	±10%	50V	0.95
61	CSA1206X7R182K501MT	X7R	1.8nF	±10%	500V	1.45
62	CSA1206X7R182K631MT	X7R	1.8nF	±10%	630V	1.45
63	CSA1206X7R182K102MT	X7R	1.8nF	±10%	1000V	1.45
64	CSA1206X7R222K500KT	X7R	2.2nF	±10%	50V	0.95
65	CSA1206X7R222K101KT	X7R	2.2nF	±10%	100V	0.95
66	CSA1206X7R222K501MT	X7R	2.2nF	±10%	500V	1.45
67	CSA1206X7R222K631MT	X7R	2.2nF	±10%	630V	1.45
68	CSA1206X7R222K102MT	X7R	2.2nF	±10%	1000V	1.45
69	CSA1206X7R272K500KT	X7R	2.7nF	±10%	50V	0.95
70	CSA1206X7R272K101KT	X7R	2.7nF	±10%	100V	0.95
71	CSA1206X7R272K501MT	X7R	2.7nF	±10%	500V	1.45
72	CSA1206X7R272K631MT	X7R	2.7nF	±10%	630V	1.45
73	CSA1206X7R272K102MT	X7R	2.7nF	±10%	1000V	1.45
74	CSA1206X7R332K500KT	X7R	3.3nF	±10%	50V	0.95
75	CSA1206X7R332K101KT	X7R	3.3nF	±10%	100V	0.95
76	CSA1206X7R332K501MT	X7R	3.3nF	±10%	500V	1.45
77	CSA1206X7R332K631MT	X7R	3.3nF	±10%	630V	1.45
78	CSA1206X7R332K102MT	X7R	3.3nF	±10%	1000V	1.45

## X7R系列料号表

尺寸: 1206(公制: 3.2mmx1.6mm)

序号	HRE料号	材质	容值	容差	耐压	最大厚度 (mm)
79	CSA1206X7R472K500KT	X7R	4.7nF	±10%	50V	0.95
80	CSA1206X7R472K101KT	X7R	4.7nF	±10%	100V	0.95
81	CSA1206X7R472K501MT	X7R	4.7nF	±10%	500V	1.45
82	CSA1206X7R472K631MT	X7R	4.7nF	±10%	630V	1.45
83	CSA1206X7R472K102MT	X7R	4.7nF	±10%	1000V	1.45
84	CSA1206X7R562K500KT	X7R	5.6nF	±10%	50V	0.95
85	CSA1206X7R562K101KT	X7R	5.6nF	±10%	100V	0.95
86	CSA1206X7R562K501MT	X7R	5.6nF	±10%	500V	1.45
87	CSA1206X7R562K631MT	X7R	5.6nF	±10%	630V	1.45
88	CSA1206X7R562K102MT	X7R	5.6nF	±10%	1000V	1.45
89	CSA1206X7R682K500KT	X7R	6.8nF	±10%	50V	0.95
90	CSA1206X7R682K101KT	X7R	6.8nF	±10%	100V	0.95
91	CSA1206X7R682K501MT	X7R	6.8nF	±10%	500V	1.45
92	CSA1206X7R682K631MT	X7R	6.8nF	±10%	630V	1.45
93	CSA1206X7R682K102MT	X7R	6.8nF	±10%	1000V	1.45
94	CSA1206X7R103K500KT	X7R	10nF	±10%	50V	0.95
95	CSA1206X7R103K101KT	X7R	10nF	±10%	100V	0.95
96	CSA1206X7R103K201MT	X7R	10nF	±10%	200V	1.45
97	CSA1206X7R103K501MT	X7R	10nF	±10%	500V	1.45
98	CSA1206X7R103K631MT	X7R	10nF	±10%	630V	1.45
99	CSA1206X7R103K102MT	X7R	10nF	±10%	1000V	1.45
100	CSA1206X7R153K500KT	X7R	15nF	±10%	50V	0.95
101	CSA1206X7R153K101KT	X7R	15nF	±10%	100V	0.95
102	CSA1206X7R153K501MT	X7R	15nF	±10%	500V	1.45
103	CSA1206X7R153K631MT	X7R	15nF	±10%	630V	1.45
104	CSA1206X7R183K500KT	X7R	18nF	±10%	50V	0.95
105	CSA1206X7R183K101KT	X7R	18nF	±10%	100V	0.95
106	CSA1206X7R183K501MT	X7R	18nF	±10%	500V	1.45
107	CSA1206X7R183K631MT	X7R	18nF	±10%	630V	1.45
108	CSA1206X7R223K500KT	X7R	22nF	±10%	50V	0.95
109	CSA1206X7R223K101KT	X7R	22nF	±10%	100V	0.95
110	CSA1206X7R223K501MT	X7R	22nF	±10%	500V	1.45
111	CSA1206X7R223K631MT	X7R	22nF	±10%	630V	1.45
112	CSA1206X7R273K500KT	X7R	27nF	±10%	50V	0.95
113	CSA1206X7R273K101KT	X7R	27nF	±10%	100V	0.95
114	CSA1206X7R333K500KT	X7R	33nF	±10%	50V	0.95



## X7R系列料号表

尺寸: 1206(公制: 3.2mmx1.6mm)

序号	HRE料号	材质	容值	容差	耐压	最大厚度 (mm)
115	CSA1206X7R333K101KT	X7R	33nF	±10%	100V	0.95
116	CSA1206X7R333K201MT	X7R	33nF	±10%	200V	1.45
117	CSA1206X7R333K251MT	X7R	33nF	±10%	250V	1.45
118	CSA1206X7R333K501NT	X7R	33nF	±10%	500V	1.80
119	CSA1206X7R333K631NT	X7R	33nF	±10%	630V	1.80
120	CSA1206X7R393K500KT	X7R	39nF	±10%	50V	0.95
121	CSA1206X7R393K101KT	X7R	39nF	±10%	100V	0.95
122	CSA1206X7R393K251MT	X7R	39nF	±10%	250V	1.45
123	CSA1206X7R473K500KT	X7R	47nF	±10%	50V	0.95
124	CSA1206X7R473K101KT	X7R	47nF	±10%	100V	0.95
125	CSA1206X7R473K251MT	X7R	47nF	±10%	250V	1.45
126	CSA1206X7R563K500KT	X7R	56nF	±10%	50V	0.95
127	CSA1206X7R563K101KT	X7R	56nF	±10%	100V	0.95
128	CSA1206X7R563K251MT	X7R	56nF	±10%	250V	1.45
129	CSA1206X7R683K500KT	X7R	68nF	±10%	50V	0.95
130	CSA1206X7R683K101KT	X7R	68nF	±10%	100V	0.95
131	CSA1206X7R683K251MT	X7R	68nF	±10%	250V	1.45
132	CSA1206X7R104K500KT	X7R	100nF	±10%	50V	0.95
133	CSA1206X7R104K101KT	X7R	100nF	±10%	100V	0.95
134	CSA1206X7R104K201MT	X7R	100nF	±10%	200V	1.45
135	CSA1206X7R104K251MT	X7R	100nF	±10%	250V	1.45
136	CSA1206X7R154K500KT	X7R	150nF	±10%	50V	0.95
137	CSA1206X7R154K101KT	X7R	150nF	±10%	100V	0.95
138	CSA1206X7R184K500KT	X7R	180nF	±10%	50V	0.95
139	CSA1206X7R184K101KT	X7R	180nF	±10%	100V	0.95
140	CSA1206X7R224K250KT	X7R	220nF	±10%	25V	0.95
141	CSA1206X7R224K500KT	X7R	220nF	±10%	50V	0.95
142	CSA1206X7R224K101KT	X7R	220nF	±10%	100V	0.95
143	CSA1206X7R274K250KT	X7R	270nF	±10%	25V	0.95
144	CSA1206X7R274K500KT	X7R	270nF	±10%	50V	0.95
145	CSA1206X7R274K101KT	X7R	270nF	±10%	100V	0.95
146	CSA1206X7R334K160KT	X7R	330nF	±10%	16V	0.95
147	CSA1206X7R334K250KT	X7R	330nF	±10%	25V	0.95
148	CSA1206X7R334K500KT	X7R	330nF	±10%	50V	0.95
149	CSA1206X7R334K101KT	X7R	330nF	±10%	100V	0.95
150	CSA1206X7R474K6R3MT	X7R	470nF	±10%	6.3V	1.45

## X7R系列料号表

尺寸: 1206(公制: 3.2mmx1.6mm)

序号	HRE料号	材质	容值	容差	耐压	最大厚度 (mm)
151	CSA1206X7R474K100MT	X7R	470nF	±10%	10V	1.45
152	CSA1206X7R474K160MT	X7R	470nF	±10%	16V	1.45
153	CSA1206X7R474K250MT	X7R	470nF	±10%	25V	1.45
154	CSA1206X7R474K500MT	X7R	470nF	±10%	50V	1.45
155	CSA1206X7R474K101MT	X7R	470nF	±10%	100V	1.45
156	CSA1206X7R684K6R3MT	X7R	680nF	±10%	6.3V	1.45
157	CSA1206X7R684K100MT	X7R	680nF	±10%	10V	1.45
158	CSA1206X7R684K160MT	X7R	680nF	±10%	16V	1.45
159	CSA1206X7R684K250MT	X7R	680nF	±10%	25V	1.45
160	CSA1206X7R684K500NT	X7R	680nF	±10%	50V	1.80
161	CSA1206X7R684K101NT	X7R	680nF	±10%	100V	1.80
162	CSA1206X7R105K6R3MT	X7R	1.0uF	±10%	6.3V	1.45
163	CSA1206X7R105K100MT	X7R	1.0uF	±10%	10V	1.45
164	CSA1206X7R105K160MT	X7R	1.0uF	±10%	16V	1.45
165	CSA1206X7R105K250MT	X7R	1.0uF	±10%	25V	1.45
166	CSA1206X7R105K500NT	X7R	1.0uF	±10%	50V	1.80
167	CSA1206X7R105K101NT	X7R	1.0uF	±10%	100V	1.80
168	CSA1206X7R155K160MT	X7R	1.5uF	±10%	16V	1.45
169	CSA1206X7R225K6R3MT	X7R	2.2uF	±10%	6.3V	1.45
170	CSA1206X7R225K100MT	X7R	2.2uF	±10%	10V	1.45
171	CSA1206X7R225K160MT	X7R	2.2uF	±10%	16V	1.45
172	CSA1206X7R225K250MT	X7R	2.2uF	±10%	25V	1.45
173	CSA1206X7R225K500MT	X7R	2.2uF	±10%	50V	1.80
174	CSA1206X7R225K101NT	X7R	2.2uF	±10%	100V	1.80
175	CSA1206X7R335K160NT	X7R	3.3uF	±10%	16V	1.45
176	CSA1206X7R475K6R3NT	X7R	4.7uF	±10%	6.3V	1.90
177	CSA1206X7R475K100NT	X7R	4.7uF	±10%	10V	1.90
178	CSA1206X7R475K160NT	X7R	4.7uF	±10%	16V	1.90
179	CSA1206X7R475K250NT	X7R	4.7uF	±10%	25V	1.90
180	CSA1206X7R475K500MT	X7R	4.7uF	±10%	50V	1.80
181	CSA1206X7R106K6R3NT	X7R	10uF	±10%	6.3V	1.90
182	CSA1206X7R106K100NT	X7R	10uF	±10%	10V	1.90
183	CSA1206X7R106K160NT	X7R	10uF	±10%	16V	1.90
184	CSA1206X7R106K250NT	X7R	10uF	±10%	25V	1.90
185	CSA1206X7R106K350NT	X7R	10uF	±10%	35V	1.90
186	CSA1206X7R106K500MT	X7R	10uF	±10%	50V	1.80

## X7R系列料号表

尺寸: 1206(公制: 3.2mmx1.6mm)

序号	HRE料号	材质	容值	容差	耐压	最大厚度 (mm)
187	CSA1206X7R226K6R3NT	X7R	22uF	±10%	6.3V	1.90
188	CSA1206X7R226K100NT	X7R	22uF	±10%	10V	1.90

尺寸: 1210(公制: 3.2mmx2.5mm)

序号	HRE料号	材质	容值	容差	耐压	最大厚度 (mm)
1	CSA1210X7R221K501MT	X7R	220pF	±10%	500V	1.45
2	CSA1210X7R221K631MT	X7R	220pF	±10%	630V	1.45
3	CSA1210X7R221K102MT	X7R	220pF	±10%	1000V	1.45
4	CSA1210X7R221K202MT	X7R	220pF	±10%	2000V	1.45
5	CSA1210X7R271K501MT	X7R	270pF	±10%	500V	1.45
6	CSA1210X7R271K631MT	X7R	270pF	±10%	630V	1.45
7	CSA1210X7R271K102MT	X7R	270pF	±10%	1000V	1.45
8	CSA1210X7R271K202MT	X7R	270pF	±10%	2000V	1.45
9	CSA1210X7R331K501MT	X7R	330pF	±10%	500V	1.45
10	CSA1210X7R331K631MT	X7R	330pF	±10%	630V	1.45
11	CSA1210X7R331K102MT	X7R	330pF	±10%	1000V	1.45
12	CSA1210X7R331K202MT	X7R	330pF	±10%	2000V	1.45
13	CSA1210X7R391K501MT	X7R	390pF	±10%	500V	1.45
14	CSA1210X7R391K631MT	X7R	390pF	±10%	630V	1.45
15	CSA1210X7R391K102MT	X7R	390pF	±10%	1000V	1.45
16	CSA1210X7R391K202MT	X7R	390pF	±10%	2000V	1.45
17	CSA1210X7R471K501MT	X7R	470pF	±10%	500V	1.45
18	CSA1210X7R471K631MT	X7R	470pF	±10%	630V	1.45
19	CSA1210X7R471K102MT	X7R	470pF	±10%	1000V	1.45
20	CSA1210X7R471K202MT	X7R	470pF	±10%	2000V	1.45
21	CSA1210X7R561K501MT	X7R	560pF	±10%	500V	1.45
22	CSA1210X7R561K631MT	X7R	560pF	±10%	630V	1.45
23	CSA1210X7R561K102MT	X7R	560pF	±10%	1000V	1.45
24	CSA1210X7R561K202MT	X7R	560pF	±10%	2000V	1.45
25	CSA1210X7R681K501MT	X7R	680pF	±10%	500V	1.45
26	CSA1210X7R681K631MT	X7R	680pF	±10%	630V	1.45
27	CSA1210X7R681K102MT	X7R	680pF	±10%	1000V	1.45
28	CSA1210X7R681K202MT	X7R	680pF	±10%	2000V	1.45
29	CSA1210X7R821K501MT	X7R	820pF	±10%	500V	1.45
30	CSA1210X7R821K631MT	X7R	820pF	±10%	630V	1.45

## X7R系列料号表

尺寸: 1210(公制: 3.2mmx2.5mm)

序号	HRE料号	材质	容值	容差	耐压	最大厚度 (mm)
31	CSA1210X7R821K102MT	X7R	820pF	±10%	1000V	1.45
32	CSA1210X7R821K202MT	X7R	820pF	±10%	2000V	1.45
33	CSA1210X7R102K501MT	X7R	1.0nF	±10%	500V	1.45
34	CSA1210X7R102K631MT	X7R	1.0nF	±10%	630V	1.45
35	CSA1210X7R102K102MT	X7R	1.0nF	±10%	1000V	1.45
36	CSA1210X7R102K202MT	X7R	1.0nF	±10%	2000V	1.45
37	CSA1210X7R152K501MT	X7R	1.5nF	±10%	500V	1.45
38	CSA1210X7R152K631MT	X7R	1.5nF	±10%	630V	1.45
39	CSA1210X7R152K102MT	X7R	1.5nF	±10%	1000V	1.45
40	CSA1210X7R152K202MT	X7R	1.5nF	±10%	2000V	1.45
41	CSA1210X7R182K501MT	X7R	1.8nF	±10%	500V	1.45
42	CSA1210X7R182K631MT	X7R	1.8nF	±10%	630V	1.45
43	CSA1210X7R182K102MT	X7R	1.8nF	±10%	1000V	1.45
44	CSA1210X7R182K202MT	X7R	1.8nF	±10%	2000V	1.45
45	CSA1210X7R222K501MT	X7R	2.2nF	±10%	500V	1.45
46	CSA1210X7R222K631MT	X7R	2.2nF	±10%	630V	1.45
47	CSA1210X7R222K102MT	X7R	2.2nF	±10%	1000V	1.45
48	CSA1210X7R222K202MT	X7R	2.2nF	±10%	2000V	1.45
49	CSA1210X7R272K501MT	X7R	2.7nF	±10%	500V	1.45
50	CSA1210X7R272K631MT	X7R	2.7nF	±10%	630V	1.45
51	CSA1210X7R272K102MT	X7R	2.7nF	±10%	1000V	1.45
52	CSA1210X7R332K501MT	X7R	3.3nF	±10%	500V	1.45
53	CSA1210X7R332K631MT	X7R	3.3nF	±10%	630V	1.45
54	CSA1210X7R332K102MT	X7R	3.3nF	±10%	1000V	1.45
55	CSA1210X7R472K501MT	X7R	4.7nF	±10%	500V	1.45
56	CSA1210X7R472K631MT	X7R	4.7nF	±10%	630V	1.45
57	CSA1210X7R472K102MT	X7R	4.7nF	±10%	1000V	1.45
58	CSA1210X7R562K501MT	X7R	5.6nF	±10%	500V	1.45
59	CSA1210X7R562K631MT	X7R	5.6nF	±10%	630V	1.45
60	CSA1210X7R562K102MT	X7R	5.6nF	±10%	1000V	1.45
61	CSA1210X7R682K501MT	X7R	6.8nF	±10%	500V	1.45
62	CSA1210X7R682K631MT	X7R	6.8nF	±10%	630V	1.45
63	CSA1210X7R682K102MT	X7R	6.8nF	±10%	1000V	1.45
64	CSA1210X7R103K251MT	X7R	10nF	±10%	250V	1.45
65	CSA1210X7R103K501MT	X7R	10nF	±10%	500V	1.45
66	CSA1210X7R103K631MT	X7R	10nF	±10%	630V	1.45

## X7R系列料号表

尺寸: 1210(公制: 3.2mmx2.5mm)

序号	HRE料号	材质	容值	容差	耐压	最大厚度 (mm)
67	CSA1210X7R103K102MT	X7R	10nF	±10%	1000V	1.45
68	CSA1210X7R153K251MT	X7R	15nF	±10%	250V	1.45
69	CSA1210X7R153K501MT	X7R	15nF	±10%	500V	1.45
70	CSA1210X7R153K631MT	X7R	15nF	±10%	630V	1.45
71	CSA1210X7R153K102MT	X7R	15nF	±10%	1000V	1.45
72	CSA1210X7R223K251MT	X7R	22nF	±10%	250V	1.45
73	CSA1210X7R223K501NT	X7R	22nF	±10%	500V	1.80
74	CSA1210X7R223K631NT	X7R	22nF	±10%	630V	1.80
75	CSA1210X7R333K251MT	X7R	33nF	±10%	250V	1.45
76	CSA1210X7R333K501NT	X7R	33nF	±10%	500V	1.80
77	CSA1210X7R333K631NT	X7R	33nF	±10%	630V	1.80
78	CSA1210X7R473K251MT	X7R	47nF	±10%	250V	1.45
79	CSA1210X7R473K501QT	X7R	47nF	±10%	500V	2.20
80	CSA1210X7R473K631QT	X7R	47nF	±10%	630V	2.20
81	CSA1210X7R563K251MT	X7R	56nF	±10%	250V	1.45
82	CSA1210X7R683K251MT	X7R	68nF	±10%	250V	1.45
83	CSA1210X7R104K101MT	X7R	100nF	±10%	100V	1.45
84	CSA1210X7R104K251MT	X7R	100nF	±10%	250V	1.45
85	CSA1210X7R154K101NT	X7R	150nF	±10%	100V	1.80
86	CSA1210X7R154K251NT	X7R	150nF	±10%	250V	1.80
87	CSA1210X7R224K101NT	X7R	220nF	±10%	100V	1.80
88	CSA1210X7R224K251QT	X7R	220nF	±10%	250V	2.20
89	CSA1210X7R334K101QT	X7R	330nF	±10%	100V	2.20
90	CSA1210X7R394K101QT	X7R	390nF	±10%	100V	2.20
91	CSA1210X7R474K6R3QT	X7R	470nF	±10%	6.3V	2.20
92	CSA1210X7R474K100QT	X7R	470nF	±10%	10V	2.20
93	CSA1210X7R474K160QT	X7R	470nF	±10%	16V	2.20
94	CSA1210X7R474K250QT	X7R	470nF	±10%	25V	2.20
95	CSA1210X7R474K500QT	X7R	470nF	±10%	50V	2.20
96	CSA1210X7R474K101QT	X7R	470nF	±10%	100V	2.20
97	CSA1210X7R684K6R3NT	X7R	680nF	±10%	6.3V	1.80
98	CSA1210X7R684K100NT	X7R	680nF	±10%	10V	1.80
99	CSA1210X7R684K160NT	X7R	680nF	±10%	16V	1.80
100	CSA1210X7R684K250NT	X7R	680nF	±10%	25V	1.80
101	CSA1210X7R684K500NT	X7R	680nF	±10%	50V	1.80
102	CSA1210X7R684K101NT	X7R	680nF	±10%	100V	2.20

## X7R系列料号表

尺寸: 1210(公制: 3.2mmx2.5mm)

序号	HRE料号	材质	容值	容差	耐压	最大厚度 (mm)
103	CSA1210X7R105K6R3NT	X7R	1.0uF	±10%	6.3V	1.80
104	CSA1210X7R105K100NT	X7R	1.0uF	±10%	10V	1.80
105	CSA1210X7R105K160NT	X7R	1.0uF	±10%	16V	1.80
106	CSA1210X7R105K250NT	X7R	1.0uF	±10%	25V	1.80
107	CSA1210X7R105K500NT	X7R	1.0uF	±10%	50V	1.80
108	CSA1210X7R105K101NT	X7R	1.0uF	±10%	100V	2.20
109	CSA1210X7R225K6R3NT	X7R	2.2uF	±10%	6.3V	1.80
110	CSA1210X7R225K100NT	X7R	2.2uF	±10%	10V	1.80
111	CSA1210X7R225K160NT	X7R	2.2uF	±10%	16V	1.80
112	CSA1210X7R225K250NT	X7R	2.2uF	±10%	25V	1.80
113	CSA1210X7R225K500NT	X7R	2.2uF	±10%	50V	1.80
114	CSA1210X7R225K101RT	X7R	2.2uF	±10%	100V	2.80
115	CSA1210X7R475K6R3NT	X7R	4.7uF	±10%	6.3V	1.80
116	CSA1210X7R475K100NT	X7R	4.7uF	±10%	10V	1.80
117	CSA1210X7R475K160NT	X7R	4.7uF	±10%	16V	1.80
118	CSA1210X7R475K250QT	X7R	4.7uF	±10%	25V	2.20
119	CSA1210X7R475K500QT	X7R	4.7uF	±10%	50V	2.20
120	CSA1210X7R106K6R3RT	X7R	10uF	±10%	6.3V	2.80
121	CSA1210X7R106K100RT	X7R	10uF	±10%	10V	2.80
122	CSA1210X7R106K160QT	X7R	10uF	±10%	16V	2.20
123	CSA1210X7R106K250RT	X7R	10uF	±10%	25V	2.80
124	CSA1210X7R106K350QT	X7R	10uF	±10%	35V	2.20
125	CSA1210X7R106K500RT	X7R	10uF	±10%	50V	2.80
126	CSA1210X7R226K6R3RT	X7R	22uF	±10%	6.3V	2.80
127	CSA1210X7R226K100RT	X7R	22uF	±10%	10V	2.80
128	CSA1210X7R226K160RT	X7R	22uF	±10%	16V	2.80
129	CSA1210X7R476K6R3RT	X7R	47uF	±10%	6.3V	2.80
130	CSA1210X7R476K100RT	X7R	47uF	±10%	10V	2.80

## X5R系列料号表

尺寸: 01005(公制: 0.4mmx0.2mm)

序号	HRE料号	材质	容值	容差	耐压	最大厚度 (mm)
1	CSA01R5X5R102K6R3DT	X5R	1.0nF	±10%	6.3V	0.22
2	CSA01R5X5R102K100DT	X5R	1.0nF	±10%	10V	0.22
3	CSA01R5X5R152K6R3DT	X5R	1.5nF	±10%	6.3V	0.22
4	CSA01R5X5R152K100DT	X5R	1.5nF	±10%	10V	0.22
5	CSA01R5X5R222K6R3DT	X5R	2.2nF	±10%	6.3V	0.22
6	CSA01R5X5R222K100DT	X5R	2.2nF	±10%	10V	0.22
7	CSA01R5X5R332K6R3DT	X5R	3.3nF	±10%	6.3V	0.22
8	CSA01R5X5R332K100DT	X5R	3.3nF	±10%	10V	0.22
9	CSA01R5X5R472K6R3DT	X5R	4.7nF	±10%	6.3V	0.22
10	CSA01R5X5R472K100DT	X5R	4.7nF	±10%	10V	0.22
11	CSA01R5X5R682K6R3DT	X5R	6.8nF	±10%	6.3V	0.22
12	CSA01R5X5R682K100DT	X5R	6.8nF	±10%	10V	0.22
13	CSA01R5X5R103K6R3DT	X5R	10nF	±10%	6.3V	0.22
14	CSA01R5X5R103K100DT	X5R	10nF	±10%	10V	0.22
15	CSA01R5X5R153K6R3DT	X5R	15nF	±10%	6.3V	0.22
16	CSA01R5X5R223K6R3DT	X5R	22nF	±10%	6.3V	0.22
17	CSA01R5X5R473K6R3DT	X5R	47nF	±10%	6.3V	0.22
18	CSA01R5X5R683K6R3DT	X5R	68nF	±10%	6.3V	0.22
19	CSA01R5X5R104K6R3DT	X5R	100nF	±10%	6.3V	0.22

尺寸: 0201(公制: 0.6mmx0.3mm)

序号	HRE料号	材质	容值	容差	耐压	最大厚度 (mm)
1	CSA0201X5R102K250ET	X5R	1.0nF	±10%	25V	0.33
2	CSA0201X5R152K250ET	X5R	1.5nF	±10%	25V	0.33
3	CSA0201X5R222K250ET	X5R	2.2nF	±10%	25V	0.33
4	CSA0201X5R332K160ET	X5R	3.3nF	±10%	16V	0.33
5	CSA0201X5R332K250ET	X5R	3.3nF	±10%	25V	0.33
6	CSA0201X5R472K100ET	X5R	4.7nF	±10%	10V	0.33
7	CSA0201X5R472K160ET	X5R	4.7nF	±10%	16V	0.33
8	CSA0201X5R472K250ET	X5R	4.7nF	±10%	25V	0.33
9	CSA0201X5R682K100ET	X5R	6.8nF	±10%	10V	0.33
10	CSA0201X5R682K160ET	X5R	6.8nF	±10%	16V	0.33
11	CSA0201X5R682K250ET	X5R	6.8nF	±10%	25V	0.33
12	CSA0201X5R103K100ET	X5R	10nF	±10%	10V	0.33

## X5R系列料号表

尺寸: 0201(公制: 0.6mmx0.3mm)

序号	HRE料号	材质	容值	容差	耐压	最大厚度 (mm)
13	CSA0201X5R103K160ET	X7R	10nF	±10%	16V	0.33
14	CSA0201X5R103K250ET	X7R	10nF	±10%	25V	0.33
15	CSA0201X5R153K6R3ET	X7R	15nF	±10%	6.3V	0.33
16	CSA0201X5R153K100ET	X7R	15nF	±10%	10V	0.33
17	CSA0201X5R153K160ET	X7R	15nF	±10%	16V	0.33
18	CSA0201X5R153K250ET	X7R	15nF	±10%	25V	0.33
19	CSA0201X5R223K6R3ET	X7R	22nF	±10%	6.3V	0.33
20	CSA0201X5R223K100ET	X7R	22nF	±10%	10V	0.33
21	CSA0201X5R223K160ET	X7R	22nF	±10%	16V	0.33
22	CSA0201X5R223K250ET	X7R	22nF	±10%	25V	0.33
23	CSA0201X5R473K6R3ET	X7R	47nF	±10%	6.3V	0.33
24	CSA0201X5R473K100ET	X7R	47nF	±10%	10V	0.33
25	CSA0201X5R473K160ET	X7R	47nF	±10%	16V	0.33
26	CSA0201X5R473K250ET	X7R	47nF	±10%	25V	0.33
27	CSA0201X5R683K6R3ET	X7R	68nF	±10%	6.3V	0.33
28	CSA0201X5R683K100ET	X7R	68nF	±10%	10V	0.33
29	CSA0201X5R683K160ET	X7R	68nF	±10%	16V	0.33
30	CSA0201X5R683K250ET	X7R	68nF	±10%	25V	0.33
31	CSA0201X5R104K6R3ET	X7R	100nF	±10%	6.3V	0.33
32	CSA0201X5R104K100ET	X7R	100nF	±10%	10V	0.33
33	CSA0201X5R104K160ET	X7R	100nF	±10%	16V	0.33
34	CSA0201X5R104K250ET	X7R	100nF	±10%	25V	0.33
35	CSA0201X5R224K6R3ET	X7R	220nF	±10%	6.3V	0.40
36	CSA0201X5R224K100ET	X7R	220nF	±10%	10V	0.40
37	CSA0201X5R474K6R3ET	X7R	470nF	±10%	6.3V	0.40
38	CSA0201X5R474K100ET	X7R	470nF	±10%	10V	0.40
39	CSA0201X5R105K6R3ET	X7R	1.0uF	±10%	6.3V	0.40
40	CSA0201X5R105K100ET	X7R	1.0uF	±10%	10V	0.40



## X5R系列料号表

尺寸: 0402(公制: 1.0mmx0.5mm)

序号	HRE料号	材质	容值	容差	耐压	最大厚度 (mm)
1	CSA0402X5R101K500GT	X5R	100pF	±10%	50V	0.60
2	CSA0402X5R121K500GT	X5R	120pF	±10%	50V	0.60
3	CSA0402X5R151K500GT	X5R	150pF	±10%	50V	0.60
4	CSA0402X5R181K500GT	X5R	180pF	±10%	50V	0.60
5	CSA0402X5R201K500GT	X5R	200pF	±10%	50V	0.60
6	CSA0402X5R221K500GT	X5R	220pF	±10%	50V	0.60
7	CSA0402X5R271K500GT	X5R	270pF	±10%	50V	0.60
8	CSA0402X5R331K500GT	X5R	330pF	±10%	50V	0.60
9	CSA0402X5R391K500GT	X5R	390pF	±10%	50V	0.60
10	CSA0402X5R471K500GT	X5R	470pF	±10%	50V	0.60
11	CSA0402X5R561K500GT	X5R	560pF	±10%	50V	0.60
12	CSA0402X5R681K500GT	X5R	680pF	±10%	50V	0.60
13	CSA0402X5R821K500GT	X5R	820pF	±10%	50V	0.60
14	CSA0402X5R102K500GT	X5R	1.0nF	±10%	50V	0.60
15	CSA0402X5R152K500GT	X5R	1.5nF	±10%	50V	0.60
16	CSA0402X5R182K500GT	X5R	1.8nF	±10%	50V	0.60
17	CSA0402X5R222K500GT	X5R	2.2nF	±10%	50V	0.60
18	CSA0402X5R272K500GT	X5R	2.7nF	±10%	50V	0.60
19	CSA0402X5R332K500GT	X5R	3.3nF	±10%	50V	0.60
20	CSA0402X5R472K500GT	X5R	4.7nF	±10%	50V	0.60
21	CSA0402X5R562K500GT	X5R	5.6nF	±10%	50V	0.60
22	CSA0402X5R103K500GT	X5R	10nF	±10%	50V	0.60
23	CSA0402X5R153K500GT	X5R	15nF	±10%	50V	0.60
24	CSA0402X5R333K500GT	X5R	33nF	±10%	50V	0.60
25	CSA0402X5R393K500GT	X5R	39nF	±10%	50V	0.60
26	CSA0402X5R473K500GT	X5R	47nF	±10%	50V	0.60
27	CSA0402X5R563K500GT	X5R	56nF	±10%	50V	0.60
28	CSA0402X5R683K500GT	X5R	68nF	±10%	50V	0.60
29	CSA0402X5R104K6R3GT	X5R	100nF	±10%	6.3V	0.60
30	CSA0402X5R104K100GT	X5R	100nF	±10%	10V	0.60
31	CSA0402X5R104K160GT	X5R	100nF	±10%	16V	0.60
32	CSA0402X5R104K250GT	X5R	100nF	±10%	25V	0.60
33	CSA0402X5R104K500GT	X5R	100nF	±10%	50V	0.60
34	CSA0402X5R154K6R3GT	X5R	150nF	±10%	6.3V	0.60
35	CSA0402X5R154K100GT	X5R	150nF	±10%	10V	0.60
36	CSA0402X5R154K160GT	X5R	150nF	±10%	16V	0.60
37	CSA0402X5R154K250GT	X5R	150nF	±10%	25V	0.60

## X5R系列料号表

尺寸: 0402(公制: 1.0mmx0.5mm)

序号	HRE料号	材质	容值	容差	耐压	最大厚度 (mm)
37	CSA0402X5R154K250GT	X5R	150nF	±10%	25V	0.60
38	CSA0402X5R184K6R3GT	X5R	180nF	±10%	6.3V	0.60
39	CSA0402X5R184K100GT	X5R	180nF	±10%	10V	0.60
40	CSA0402X5R184K160GT	X5R	180nF	±10%	16V	0.60
41	CSA0402X5R184K250GT	X5R	180nF	±10%	25V	0.60
42	CSA0402X5R224K6R3GT	X5R	220nF	±10%	6.3V	0.60
43	CSA0402X5R224K100GT	X5R	220nF	±10%	10V	0.60
44	CSA0402X5R224K160GT	X5R	220nF	±10%	16V	0.60
45	CSA0402X5R224K250GT	X5R	220nF	±10%	25V	0.60
46	CSA0402X5R274K6R3GT	X5R	270nF	±10%	6.3V	0.60
47	CSA0402X5R274K100GT	X5R	270nF	±10%	10V	0.60
48	CSA0402X5R274K160GT	X5R	270nF	±10%	16V	0.60
49	CSA0402X5R274K250GT	X5R	270nF	±10%	25V	0.60
50	CSA0402X5R334K6R3GT	X5R	330nF	±10%	6.3V	0.60
51	CSA0402X5R334K100GT	X5R	330nF	±10%	10V	0.60
52	CSA0402X5R334K160GT	X5R	330nF	±10%	16V	0.60
53	CSA0402X5R334K250GT	X5R	330nF	±10%	25V	0.60
54	CSA0402X5R474K6R3GT	X5R	470nF	±10%	6.3V	0.60
55	CSA0402X5R474K100GT	X5R	470nF	±10%	10V	0.60
56	CSA0402X5R474K160GT	X5R	470nF	±10%	16V	0.60
57	CSA0402X5R474K250GT	X5R	470nF	±10%	25V	0.60
58	CSA0402X5R684K6R3GT	X5R	680nF	±10%	6.3V	0.60
59	CSA0402X5R684K100GT	X5R	680nF	±10%	10V	0.60
60	CSA0402X5R684K160GT	X5R	680nF	±10%	16V	0.60
61	CSA0402X5R684K250GT	X5R	680nF	±10%	25V	0.60
62	CSA0402X5R105K6R3GT	X5R	1.0uF	±10%	6.3V	0.60
63	CSA0402X5R105K100GT	X5R	1.0uF	±10%	10V	0.60
64	CSA0402X5R105K160GT	X5R	1.0uF	±10%	16V	0.60
65	CSA0402X5R105K250GT	X5R	1.0uF	±10%	25V	0.60
66	CSA0402X5R105K350GT	X5R	1.0uF	±10%	35V	0.60
67	CSA0402X5R225K6R3GT	X5R	2.2uF	±10%	6.3V	0.70
68	CSA0402X5R225K100GT	X5R	2.2uF	±10%	10V	0.70
69	CSA0402X5R225K160GT	X5R	2.2uF	±10%	16V	0.70
70	CSA0402X5R225K250GT	X5R	2.2uF	±10%	25V	0.70
71	CSA0402X5R475M6R3GT	X5R	4.7uF	±20%	6.3V	0.70
72	CSA0402X5R475M100GT	X5R	4.7uF	±20%	10V	0.70

## X5R系列料号表

尺寸: 0603(公制: 1.6mmx0.8mm)

序号	HRE料号	材质	容值	容差	耐压	最大厚度 (mm)
1	CSA0603X5R221K500JT	X5R	220pF	±10%	50V	0.90
2	CSA0603X5R271K500JT	X5R	270pF	±10%	50V	0.90
3	CSA0603X5R331K500JT	X5R	330pF	±10%	50V	0.90
4	CSA0603X5R391K500JT	X5R	390pF	±10%	50V	0.90
5	CSA0603X5R471K500JT	X5R	470pF	±10%	50V	0.90
6	CSA0603X5R561K500JT	X5R	560pF	±10%	50V	0.90
7	CSA0603X5R681K500JT	X5R	680pF	±10%	50V	0.90
8	CSA0603X5R821K500JT	X5R	820pF	±10%	50V	0.90
9	CSA0603X5R102K500JT	X5R	1.0nF	±10%	50V	0.90
10	CSA0603X5R152K500JT	X5R	1.5nF	±10%	50V	0.90
11	CSA0603X5R182K500JT	X5R	1.8nF	±10%	50V	0.90
12	CSA0603X5R222K500JT	X5R	2.2nF	±10%	50V	0.90
13	CSA0603X5R272K500JT	X5R	2.7nF	±10%	50V	0.90
14	CSA0603X5R332K500JT	X5R	3.3nF	±10%	50V	0.90
15	CSA0603X5R472K500JT	X5R	4.7nF	±10%	50V	0.90
16	CSA0603X5R562K500JT	X5R	5.6nF	±10%	50V	0.90
17	CSA0603X5R682K500JT	X5R	6.8nF	±10%	50V	0.90
18	CSA0603X5R103K500JT	X5R	10nF	±10%	50V	0.90
19	CSA0603X5R153K500JT	X5R	15nF	±10%	50V	0.90
20	CSA0603X5R183K500JT	X5R	18nF	±10%	50V	0.90
21	CSA0603X5R223K500JT	X5R	22nF	±10%	50V	0.90
22	CSA0603X5R273K500JT	X5R	27nF	±10%	50V	0.90
23	CSA0603X5R333K500JT	X5R	33nF	±10%	50V	0.90
24	CSA0603X5R393K500JT	X5R	39nF	±10%	50V	0.90
25	CSA0603X5R473K500JT	X5R	47nF	±10%	50V	0.90
26	CSA0603X5R563K500JT	X5R	56nF	±10%	50V	0.90
27	CSA0603X5R683K500JT	X5R	68nF	±10%	50V	0.90
28	CSA0603X5R104K250JT	X5R	100nF	±10%	25V	0.90
29	CSA0603X5R104K500JT	X5R	100nF	±10%	50V	0.90
30	CSA0603X5R154K250JT	X5R	150nF	±10%	25V	0.90
31	CSA0603X5R154K500JT	X5R	150nF	±10%	50V	0.90
32	CSA0603X5R184K250JT	X5R	180nF	±10%	25V	0.90
33	CSA0603X5R184K500JT	X5R	180nF	±10%	50V	0.90
34	CSA0603X5R224K100JT	X5R	220nF	±10%	10V	0.90
35	CSA0603X5R224K160JT	X5R	220nF	±10%	16V	0.90
36	CSA0603X5R224K250JT	X5R	220nF	±10%	25V	0.90

## X5R系列料号表

尺寸: 0603(公制: 1.6mmx0.8mm)

序号	HRE料号	材质	容值	容差	耐压	最大厚度 (mm)
37	CSA0603X5R224K500JT	X5R	220nF	±10%	50V	1.00
38	CSA0603X5R274K100JT	X5R	270nF	±10%	10V	0.90
39	CSA0603X5R274K160JT	X5R	270nF	±10%	16V	0.90
40	CSA0603X5R274K250JT	X5R	270nF	±10%	25V	0.90
41	CSA0603X5R274K500JT	X5R	270nF	±10%	50V	1.00
42	CSA0603X5R334K100JT	X5R	330nF	±10%	10V	0.90
43	CSA0603X5R334K160JT	X5R	330nF	±10%	16V	0.90
44	CSA0603X5R334K250JT	X5R	330nF	±10%	25V	1.00
45	CSA0603X5R334K500JT	X5R	330nF	±10%	50V	1.00
46	CSA0603X5R474K6R3JT	X5R	470nF	±10%	6.3V	0.90
47	CSA0603X5R474K100JT	X5R	470nF	±10%	10V	0.90
48	CSA0603X5R474K160JT	X5R	470nF	±10%	16V	0.90
49	CSA0603X5R474K250JT	X5R	470nF	±10%	25V	1.00
50	CSA0603X5R474K500JT	X5R	470nF	±10%	50V	1.00
51	CSA0603X5R684K6R3JT	X5R	680nF	±10%	6.3V	0.90
52	CSA0603X5R684K100JT	X5R	680nF	±10%	10V	0.90
53	CSA0603X5R684K160JT	X5R	680nF	±10%	16V	0.90
54	CSA0603X5R684K250JT	X5R	680nF	±10%	25V	1.00
55	CSA0603X5R684K500JT	X5R	680nF	±10%	50V	1.00
56	CSA0603X5R105K6R3JT	X5R	1.0uF	±10%	6.3V	0.90
57	CSA0603X5R105K100JT	X5R	1.0uF	±10%	10V	0.90
58	CSA0603X5R105K160JT	X5R	1.0uF	±10%	16V	0.90
59	CSA0603X5R105K250JT	X5R	1.0uF	±10%	25V	1.00
60	CSA0603X5R105K350JT	X5R	1.0uF	±10%	35V	1.00
61	CSA0603X5R105K500JT	X5R	1.0uF	±10%	50V	1.00
62	CSA0603X5R225K6R3JT	X5R	2.2uF	±10%	6.3V	0.90
63	CSA0603X5R225K100JT	X5R	2.2uF	±10%	10V	0.90
64	CSA0603X5R225K160JT	X5R	2.2uF	±10%	16V	1.00
65	CSA0603X5R225K250JT	X5R	2.2uF	±10%	25V	1.00
66	CSA0603X5R225K350JT	X5R	2.2uF	±10%	35V	1.00
67	CSA0603X5R225K500JT	X5R	2.2uF	±10%	50V	1.00
68	CSA0603X5R475K6R3JT	X5R	4.7uF	±10%	6.3V	1.00
69	CSA0603X5R475K100JT	X5R	4.7uF	±10%	10V	1.00
70	CSA0603X5R475K160JT	X5R	4.7uF	±10%	16V	1.00
71	CSA0603X5R475K250JT	X5R	4.7uF	±10%	25V	1.00
72	CSA0603X5R475K350JT	X5R	4.7uF	±10%	35V	1.00

## X5R系列料号表

尺寸: 0603(公制: 1.6mmx0.8mm)

序号	HRE料号	材质	容值	容差	耐压	最大厚度 (mm)
73	CSA0603X5R106K6R3JT	X5R	10uF	±10%	6.3V	1.00
74	CSA0603X5R106K100JT	X5R	10uF	±10%	10V	1.00
75	CSA0603X5R106K160JT	X5R	10uF	±10%	16V	1.00
76	CSA0603X5R226M6R3JT	X5R	22uF	±20%	6.3V	1.00
77	CSA0603X5R226M100JT	X5R	22uF	±20%	10V	1.00
78	CSA0603X5R226M160JT	X5R	22uF	±20%	16V	1.00

尺寸: 0805(公制: 2.0mmx1.25mm)

序号	HRE料号	材质	容值	容差	耐压	最大厚度 (mm)
1	CSA0805X5R221K500KT	X5R	220pF	±10%	50V	0.95
2	CSA0805X5R271K500KT	X5R	270pF	±10%	50V	0.95
3	CSA0805X5R331K500KT	X5R	330pF	±10%	50V	0.95
4	CSA0805X5R391K500KT	X5R	390pF	±10%	50V	0.95
5	CSA0805X5R471K500KT	X5R	470pF	±10%	50V	0.95
6	CSA0805X5R561K500KT	X5R	560pF	±10%	50V	0.95
7	CSA0805X5R681K500KT	X5R	680pF	±10%	50V	0.95
8	CSA0805X5R821K500KT	X5R	820pF	±10%	50V	0.95
9	CSA0805X5R102K500KT	X5R	1.0nF	±10%	50V	0.95
10	CSA0805X5R152K500KT	X5R	1.5nF	±10%	50V	0.95
11	CSA0805X5R182K500KT	X5R	1.8nF	±10%	50V	0.95
12	CSA0805X5R222K500KT	X5R	2.2nF	±10%	50V	0.95
13	CSA0805X5R272K500KT	X5R	2.7nF	±10%	50V	0.95
14	CSA0805X5R332K500KT	X5R	3.3nF	±10%	50V	0.95
15	CSA0805X5R472K500KT	X5R	4.7nF	±10%	50V	0.95
16	CSA0805X5R562K500KT	X5R	5.6nF	±10%	50V	0.95
17	CSA0805X5R682K500KT	X5R	6.8nF	±10%	50V	0.95
18	CSA0805X5R103K500KT	X5R	10nF	±10%	50V	0.95
19	CSA0805X5R153K500KT	X5R	15nF	±10%	50V	0.95
20	CSA0805X5R183K500KT	X5R	18nF	±10%	50V	0.95
21	CSA0805X5R223K500KT	X5R	22nF	±10%	50V	0.95
22	CSA0805X5R273K500KT	X5R	27nF	±10%	50V	0.95
23	CSA0805X5R333K500KT	X5R	33nF	±10%	50V	0.95
24	CSA0805X5R393K500KT	X5R	39nF	±10%	50V	0.95
25	CSA0805X5R473K500KT	X5R	47nF	±10%	50V	0.95
26	CSA0805X5R563K500KT	X5R	56nF	±10%	50V	0.95

## X5R系列料号表

尺寸: 0805(公制: 2.0mmx1.25mm)

序号	HRE料号	材质	容值	容差	耐压	最大厚度 (mm)
27	CSA0805X5R683K500KT	X5R	68nF	±10%	50V	0.95
28	CSA0805X5R104K160KT	X5R	100nF	±10%	16V	0.95
29	CSA0805X5R104K250KT	X5R	100nF	±10%	25V	0.95
30	CSA0805X5R104K500KT	X5R	100nF	±10%	50V	0.95
31	CSA0805X5R154K160KT	X5R	150nF	±10%	16V	0.95
32	CSA0805X5R154K250KT	X5R	150nF	±10%	25V	0.95
33	CSA0805X5R154K500KT	X5R	150nF	±10%	50V	0.95
34	CSA0805X5R184K160KT	X5R	180nF	±10%	16V	0.95
35	CSA0805X5R184K250KT	X5R	180nF	±10%	25V	0.95
36	CSA0805X5R184K500KT	X5R	180nF	±10%	50V	0.95
37	CSA0805X5R224K160KT	X5R	220nF	±10%	16V	0.95
38	CSA0805X5R224K250KT	X5R	220nF	±10%	25V	0.95
39	CSA0805X5R224K500KT	X5R	220nF	±10%	50V	0.95
40	CSA0805X5R274K160KT	X5R	270nF	±10%	16V	0.95
41	CSA0805X5R274K250KT	X5R	270nF	±10%	25V	0.95
42	CSA0805X5R274K500KT	X5R	270nF	±10%	50V	0.95
43	CSA0805X5R334K160KT	X5R	330nF	±10%	16V	0.95
44	CSA0805X5R334K250KT	X5R	330nF	±10%	25V	0.95
45	CSA0805X5R334K500KT	X5R	330nF	±10%	50V	0.95
46	CSA0805X5R474K6R3KT	X5R	470nF	±10%	6.3V	0.95
47	CSA0805X5R474K100KT	X5R	470nF	±10%	10V	0.95
48	CSA0805X5R474K160MT	X5R	470nF	±10%	16V	1.45
49	CSA0805X5R474K250MT	X5R	470nF	±10%	25V	1.45
50	CSA0805X5R474K500KT	X5R	470nF	±10%	50V	0.95
51	CSA0805X5R684K6R3KT	X5R	680nF	±10%	6.3V	0.95
52	CSA0805X5R684K100KT	X5R	680nF	±10%	10V	0.95
53	CSA0805X5R684K160MT	X5R	680nF	±10%	16V	1.45
54	CSA0805X5R684K250MT	X5R	680nF	±10%	25V	1.45
55	CSA0805X5R684K500KT	X5R	680nF	±10%	50V	0.95
56	CSA0805X5R105K6R3KT	X5R	1.0uF	±10%	6.3V	0.95
57	CSA0805X5R105K100KT	X5R	1.0uF	±10%	10V	0.95
58	CSA0805X5R105K160MT	X5R	1.0uF	±10%	16V	1.45
59	CSA0805X5R105K250MT	X5R	1.0uF	±10%	25V	1.45
60	CSA0805X5R105K500MT	X5R	1.0uF	±10%	50V	1.45
61	CSA0805X5R225K6R3MT	X5R	2.2uF	±10%	6.3V	1.45

## X5R系列料号表

尺寸: 0805(公制: 2.0mmx1.25mm)

序号	HRE料号	材质	容值	容差	耐压	最大厚度 (mm)
62	CSA0805X5R225K100MT	X5R	2.2uF	±10%	10V	1.45
63	CSA0805X5R225K160MT	X5R	2.2uF	±10%	16V	1.45
64	CSA0805X5R225K250MT	X5R	2.2uF	±10%	25V	1.45
65	CSA0805X5R225K500MT	X5R	2.2uF	±10%	50V	1.45
66	CSA0805X5R475K6R3MT	X5R	4.7uF	±10%	6.3V	1.45
67	CSA0805X5R475K100MT	X5R	4.7uF	±10%	10V	1.45
68	CSA0805X5R475K160MT	X5R	4.7uF	±10%	16V	1.45
69	CSA0805X5R475K250MT	X5R	4.7uF	±10%	25V	1.45
70	CSA0805X5R475K350MT	X5R	4.7uF	±10%	35V	1.45
71	CSA0805X5R475K500MT	X5R	4.7uF	±10%	50V	1.45
72	CSA0805X5R106K6R3MT	X5R	10uF	±10%	6.3V	1.45
73	CSA0805X5R106K100MT	X5R	10uF	±10%	10V	1.45
74	CSA0805X5R106K160MT	X5R	10uF	±10%	16V	1.45
75	CSA0805X5R106K250MT	X5R	10uF	±10%	25V	1.45
76	CSA0805X5R106K500MT	X5R	10uF	±10%	50V	1.45
77	CSA0805X5R226M6R3MT	X5R	22uF	±20%	6.3V	1.45
78	CSA0805X5R226M100MT	X5R	22uF	±20%	10V	1.45
79	CSA0805X5R226M160MT	X5R	22uF	±20%	16V	1.45
80	CSA0805X5R226M250MT	X5R	22uF	±20%	25V	1.45
81	CSA0805X5R476M6R3MT	X5R	47uF	±20%	6.3V	1.45

尺寸: 1206(公制: 3.2mmx1.6mm)

序号	HRE料号	材质	容值	容差	耐压	最大厚度 (mm)
1	CSA1206X5R221K500KT	X5R	220pF	±10%	50V	0.95
2	CSA1206X5R271K500KT	X5R	270pF	±10%	50V	0.95
3	CSA1206X5R331K500KT	X5R	330pF	±10%	50V	0.95
4	CSA1206X5R391K500KT	X5R	390pF	±10%	50V	0.95
5	CSA1206X5R471K500KT	X5R	470pF	±10%	50V	0.95
6	CSA1206X5R561K500KT	X5R	560pF	±10%	50V	0.95
7	CSA1206X5R681K500KT	X5R	680pF	±10%	50V	0.95
8	CSA1206X5R821K500KT	X5R	820pF	±10%	50V	0.95
9	CSA1206X5R102K500KT	X5R	1.0nF	±10%	50V	0.95
10	CSA1206X5R152K500KT	X5R	1.5nF	±10%	50V	0.95

## X5R系列料号表

尺寸: 1206(公制: 3.2mmx1.6mm)

序号	HRE料号	材质	容值	容差	耐压	最大厚度 (mm)
11	CSA1206X5R182K500KT	X5R	1.8nF	±10%	50V	0.95
12	CSA1206X5R222K500KT	X5R	2.2nF	±10%	50V	0.95
13	CSA1206X5R272K500KT	X5R	2.7nF	±10%	50V	0.95
14	CSA1206X5R332K500KT	X5R	3.3nF	±10%	50V	0.95
15	CSA1206X5R472K500KT	X5R	4.7nF	±10%	50V	0.95
16	CSA1206X5R562K500KT	X5R	5.6nF	±10%	50V	0.95
17	CSA1206X5R682K500KT	X5R	6.8nF	±10%	50V	0.95
18	CSA1206X5R103K500KT	X5R	10nF	±10%	50V	0.95
19	CSA1206X5R153K500KT	X5R	15nF	±10%	50V	0.95
20	CSA1206X5R183K500KT	X5R	18nF	±10%	50V	0.95
21	CSA1206X5R223K500KT	X5R	22nF	±10%	50V	0.95
22	CSA1206X5R273K500KT	X5R	27nF	±10%	50V	0.95
23	CSA1206X5R333K500KT	X5R	33nF	±10%	50V	0.95
24	CSA1206X5R393K500KT	X5R	39nF	±10%	50V	0.95
25	CSA1206X5R473K500KT	X5R	47nF	±10%	50V	0.95
26	CSA1206X5R563K500KT	X5R	56nF	±10%	50V	0.95
27	CSA1206X5R683K500KT	X5R	68nF	±10%	50V	0.95
28	CSA1206X5R104K250KT	X5R	100nF	±10%	25V	0.95
29	CSA1206X5R104K500KT	X5R	100nF	±10%	50V	0.95
30	CSA1206X5R154K250KT	X5R	150nF	±10%	25V	0.95
31	CSA1206X5R154K500KT	X5R	150nF	±10%	50V	0.95
32	CSA1206X5R184K250KT	X5R	180nF	±10%	25V	0.95
33	CSA1206X5R184K500KT	X5R	180nF	±10%	50V	0.95
34	CSA1206X5R224K160KT	X5R	220nF	±10%	16V	0.95
35	CSA1206X5R224K250KT	X5R	220nF	±10%	25V	0.95
36	CSA1206X5R224K500KT	X5R	220nF	±10%	50V	0.95
37	CSA1206X5R274K160KT	X5R	270nF	±10%	16V	0.95
38	CSA1206X5R274K250KT	X5R	270nF	±10%	25V	0.95
39	CSA1206X5R274K500KT	X5R	270nF	±10%	50V	0.95
40	CSA1206X5R334K160KT	X5R	330nF	±10%	16V	0.95
41	CSA1206X5R334K250KT	X5R	330nF	±10%	25V	0.95
42	CSA1206X5R334K500KT	X5R	330nF	±10%	50V	0.95
43	CSA1206X5R474K6R3MT	X5R	470nF	±10%	6.3V	1.45
44	CSA1206X5R474K100MT	X5R	470nF	±10%	10V	1.45
45	CSA1206X5R474K160MT	X5R	470nF	±10%	16V	1.45



## X5R系列料号表

尺寸: 1206(公制: 3.2mmx1.6mm)

序号	HRE料号	材质	容值	容差	耐压	最大厚度 (mm)
46	CSA1206X5R474K250MT	X5R	470nF	±10%	25V	1.45
47	CSA1206X5R474K500MT	X5R	470nF	±10%	50V	1.45
48	CSA1206X5R684K6R3MT	X5R	680nF	±10%	6.3V	1.45
49	CSA1206X5R684K100MT	X5R	680nF	±10%	10V	1.45
50	CSA1206X5R684K160MT	X5R	680nF	±10%	16V	1.45
51	CSA1206X5R684K250MT	X5R	680nF	±10%	25V	1.45
52	CSA1206X5R684K500NT	X5R	680nF	±10%	50V	1.80
53	CSA1206X5R105K6R3MT	X5R	1.0uF	±10%	6.3V	1.45
54	CSA1206X5R105K100MT	X5R	1.0uF	±10%	10V	1.45
55	CSA1206X5R105K160MT	X5R	1.0uF	±10%	16V	1.45
56	CSA1206X5R105K250MT	X5R	1.0uF	±10%	25V	1.45
57	CSA1206X5R105K500NT	X5R	1.0uF	±10%	50V	1.80
58	CSA1206X5R225K6R3MT	X5R	2.2uF	±10%	6.3V	1.45
59	CSA1206X5R225K100MT	X5R	2.2uF	±10%	10V	1.45
60	CSA1206X5R225K160MT	X5R	2.2uF	±10%	16V	1.45
61	CSA1206X5R225K250MT	X5R	2.2uF	±10%	25V	1.45
62	CSA1206X5R225K500NT	X5R	2.2uF	±10%	50V	1.80
63	CSA1206X5R475K6R3NT	X5R	4.7uF	±10%	6.3V	1.90
64	CSA1206X5R475K100NT	X5R	4.7uF	±10%	10V	1.90
65	CSA1206X5R475K160NT	X5R	4.7uF	±10%	16V	1.90
66	CSA1206X5R475K250NT	X5R	4.7uF	±10%	25V	1.90
67	CSA1206X5R475K350NT	X5R	4.7uF	±10%	35V	1.90
68	CSA1206X5R475K500NT	X5R	4.7uF	±10%	50V	1.80
69	CSA1206X5R106K6R3NT	X5R	10uF	±10%	6.3V	1.90
70	CSA1206X5R106K100NT	X5R	10uF	±10%	10V	1.90
71	CSA1206X5R106K160NT	X5R	10uF	±10%	16V	1.90
72	CSA1206X5R106K250NT	X5R	10uF	±10%	25V	1.90
73	CSA1206X5R106K500NT	X5R	10uF	±10%	50V	1.80
74	CSA1206X5R226M6R3NT	X5R	22uF	±20%	6.3V	1.90
75	CSA1206X5R226M100NT	X5R	22uF	±10%	10V	1.90
76	CSA1206X5R226M160NT	X5R	22uF	±20%	16V	1.90
77	CSA1206X5R226M250NT	X5R	22uF	±20%	25V	1.90
78	CSA1206X5R476M6R3NT	X5R	47uF	±20%	6.3V	1.90
79	CSA1206X5R476M100NT	X5R	47uF	±20%	10V	1.90

## X5R系列料号表

尺寸: 1210(公制: 3.2mmx2.5mm)

序号	HRE料号	材质	容值	容差	耐压	最大厚度 (mm)
1	CSA1210X5R474K6R3QT	X5R	470nF	±10%	6.3V	2.20
2	CSA1210X5R474K100QT	X5R	470nF	±10%	10V	2.20
3	CSA1210X5R474K160QT	X5R	470nF	±10%	16V	2.20
4	CSA1210X5R474K250QT	X5R	470nF	±10%	25V	2.20
5	CSA1210X5R474K500QT	X5R	470nF	±10%	50V	2.20
6	CSA1210X5R684K6R3NT	X5R	680nF	±10%	6.3V	1.80
7	CSA1210X5R684K100NT	X5R	680nF	±10%	10V	1.80
8	CSA1210X5R684K160NT	X5R	680nF	±10%	16V	1.80
9	CSA1210X5R684K250QT	X5R	680nF	±10%	25V	1.80
10	CSA1210X5R684K500NT	X5R	680nF	±10%	50V	1.80
11	CSA1210X5R105K6R3NT	X5R	1.0uF	±10%	6.3V	1.80
12	CSA1210X5R105K100NT	X5R	1.0uF	±10%	10V	1.80
13	CSA1210X5R105K160NT	X5R	1.0uF	±10%	16V	1.80
14	CSA1210X5R105K250NT	X5R	1.0uF	±10%	25V	1.80
15	CSA1210X5R105K500NT	X5R	1.0uF	±10%	50V	1.80
16	CSA1210X5R225K6R3NT	X5R	2.2uF	±10%	6.3V	1.80
17	CSA1210X5R225K100NT	X5R	2.2uF	±10%	10V	1.80
18	CSA1210X5R225K160NT	X5R	2.2uF	±10%	16V	1.80
19	CSA1210X5R225K250NT	X5R	2.2uF	±10%	25V	1.80
20	CSA1210X5R225K500NT	X5R	2.2uF	±10%	50V	1.80
21	CSA1210X5R475K6R3NT	X5R	4.7uF	±10%	6.3V	1.80
22	CSA1210X5R475K100NT	X5R	4.7uF	±10%	10V	1.80
23	CSA1210X5R475K160NT	X5R	4.7uF	±10%	16V	1.80
24	CSA1210X5R475K250NT	X5R	4.7uF	±10%	25V	2.20
25	CSA1210X5R475K350NT	X5R	4.7uF	±10%	35V	2.20
26	CSA1210X5R106K6R3RT	X5R	10uF	±10%	6.3V	2.80
27	CSA1210X5R106K100RT	X5R	10uF	±10%	10V	2.80
28	CSA1210X5R106K160QT	X5R	10uF	±10%	16V	2.20
29	CSA1210X5R106K250RT	X5R	10uF	±10%	25V	2.80
30	CSA1210X5R106K350RT	X5R	10uF	±10%	35V	2.80
31	CSA1210X5R106M500RT	X5R	10uF	±20%	50V	2.80
32	CSA1210X5R226K6R3RT	X5R	22uF	±10%	6.3V	2.80
33	CSA1210X5R226K100RT	X5R	22uF	±10%	10V	2.80
34	CSA1210X5R226K160RT	X5R	22uF	±10%	16V	2.80
35	CSA1210X5R226M250RT	X5R	22uF	±20%	25V	2.80

## X5R系列料号表

尺寸: 1210(公制: 3.2mmx2.5mm)

序号	HRE料号	材质	容值	容差	耐压	最大厚度 (mm)
36	CSA1210X5R476K6R3RT	X5R	47uF	±10%	6.3V	2.80
37	CSA1210X5R476K100RT	X5R	47uF	±10%	10V	2.80
38	CSA1210X5R476M160RT	X5R	47uF	±20%	16V	2.80
39	CSA1210X5R107M6R3RT	X5R	100uF	±20%	6.3V	2.80
40	CSA1210X5R107M100RT	X5R	100uF	±20%	6.3V	2.80

## X6S系列料号表

尺寸: 0201(公制: 0.6mmx0.3mm)

序号	HRE料号	材质	容值	容差	耐压	最大厚度 (mm)
1	CSA0201X6S101K250ET	X6S	100pF	±10%	25V	0.33
2	CSA0201X6S121K250ET	X6S	120pF	±10%	25V	0.33
3	CSA0201X6S151K250ET	X6S	150pF	±10%	25V	0.33
4	CSA0201X6S181K250ET	X6S	180pF	±10%	25V	0.33
5	CSA0201X6S221K250ET	X6S	220pF	±10%	25V	0.33
6	CSA0201X6S271K250ET	X6S	270pF	±10%	25V	0.33
7	CSA0201X6S331K250ET	X6S	330pF	±10%	25V	0.33
8	CSA0201X6S391K250ET	X6S	390pF	±10%	25V	0.33
9	CSA0201X6S471K250ET	X6S	470pF	±10%	25V	0.33
10	CSA0201X6S561K250ET	X6S	560pF	±10%	25V	0.33
11	CSA0201X6S681K250ET	X6S	680pF	±10%	25V	0.33
12	CSA0201X6S821K250ET	X6S	820pF	±10%	25V	0.33
13	CSA0201X6S102K160ET	X6S	1.0nF	±10%	16V	0.33
14	CSA0201X6S102K250ET	X6S	1.0nF	±10%	25V	0.33
15	CSA0201X6S152K160ET	X6S	1.5nF	±10%	16V	0.33
16	CSA0201X6S152K250ET	X6S	1.5nF	±10%	25V	0.33
17	CSA0201X6S182K160ET	X6S	1.8nF	±10%	16V	0.33
18	CSA0201X6S182K250ET	X6S	1.8nF	±10%	25V	0.33
19	CSA0201X6S222K160ET	X6S	2.2nF	±10%	16V	0.33
20	CSA0201X6S222K250ET	X6S	2.2nF	±10%	25V	0.33
21	CSA0201X6S272K160ET	X6S	2.7nF	±10%	16V	0.33
22	CSA0201X6S272K250ET	X6S	2.7nF	±10%	25V	0.33
23	CSA0201X6S332K160ET	X6S	3.3nF	±10%	16V	0.33
24	CSA0201X6S332K250ET	X6S	3.3nF	±10%	25V	0.33
25	CSA0201X6S472K160ET	X6S	4.7nF	±10%	16V	0.33
26	CSA0201X6S472K250ET	X6S	4.7nF	±10%	25V	0.33
27	CSA0201X6S562K160ET	X6S	5.6nF	±10%	16V	0.33
28	CSA0201X6S562K250ET	X6S	5.6nF	±10%	25V	0.33
29	CSA0201X6S103K160ET	X6S	10nF	±10%	16V	0.33
30	CSA0201X6S103K250ET	X6S	10nF	±10%	25V	0.33
31	CSA0201X6S153K160ET	X6S	15nF	±10%	16V	0.33
32	CSA0201X6S153K250ET	X6S	15nF	±10%	25V	0.33
33	CSA0201X6S223K160ET	X6S	22nF	±10%	16V	0.33
34	CSA0201X6S223K250ET	X6S	22nF	±10%	25V	0.33
35	CSA0201X6S333K160ET	X6S	33nF	±10%	16V	0.33

## X6S系列料号表

尺寸: 0201(公制: 0.6mmx0.3mm)

序号	HRE料号	材质	容值	容差	耐压	最大厚度 (mm)
36	CSA0201X6S473K160ET	X6S	47nF	±10%	16V	0.33
37	CSA0201X6S563K160ET	X6S	56nF	±10%	16V	0.33
38	CSA0201X6S683K160ET	X6S	68nF	±10%	16V	0.33
39	CSA0201X6S823K160ET	X6S	82nF	±10%	16V	0.33
40	CSA0201X6S104K6R3ET	X6S	100nF	±10%	6.3V	0.33
41	CSA0201X6S104K100ET	X6S	100nF	±10%	10V	0.33
42	CSA0201X6S104K160ET	X6S	100nF	±10%	16V	0.33
43	CSA0201X6S224K6R3ET	X6S	220nF	±10%	6.3V	0.40
44	CSA0201X6S224K100ET	X6S	220nF	±10%	10V	0.40

尺寸: 0402(公制: 1.0mmx0.5mm)

序号	HRE料号	材质	容值	容差	耐压	最大厚度 (mm)
1	CSA0402X6S101K250GT	X6S	100pF	±10%	25V	0.60
2	CSA0402X6S101K500GT	X6S	100pF	±10%	50V	0.60
3	CSA0402X6S121K250GT	X6S	120pF	±10%	25V	0.60
4	CSA0402X6S121K500GT	X6S	120pF	±10%	50V	0.60
5	CSA0402X6S151K250GT	X6S	150pF	±10%	25V	0.60
6	CSA0402X6S151K500GT	X6S	150pF	±10%	50V	0.60
7	CSA0402X6S181K250GT	X6S	180pF	±10%	25V	0.60
8	CSA0402X6S181K500GT	X6S	180pF	±10%	50V	0.60
9	CSA0402X6S201K250GT	X6S	200pF	±10%	25V	0.60
10	CSA0402X6S201K500GT	X6S	200pF	±10%	50V	0.60
11	CSA0402X6S221K250GT	X6S	220pF	±10%	25V	0.60
12	CSA0402X6S221K500GT	X6S	220pF	±10%	50V	0.60
13	CSA0402X6S271K250GT	X6S	270pF	±10%	25V	0.60
14	CSA0402X6S271K500GT	X6S	270pF	±10%	50V	0.60
15	CSA0402X6S331K250GT	X6S	330pF	±10%	25V	0.60
16	CSA0402X6S331K500GT	X6S	330pF	±10%	50V	0.60
17	CSA0402X6S391K250GT	X6S	390pF	±10%	25V	0.60
18	CSA0402X6S391K500GT	X6S	390pF	±10%	50V	0.60
19	CSA0402X6S471K250GT	X6S	470pF	±10%	25V	0.60
20	CSA0402X6S471K500GT	X6S	470pF	±10%	50V	0.60
21	CSA0402X6S561K250GT	X6S	560pF	±10%	25V	0.60

## X6S系列料号表

尺寸: 0402(公制: 1.0mmx0.5mm)

序号	HRE料号	材质	容值	容差	耐压	最大厚度 (mm)
22	CSA0402X6S561K500GT	X6S	560pF	±10%	50V	0.60
23	CSA0402X6S681K250GT	X6S	680pF	±10%	25V	0.60
24	CSA0402X6S681K500GT	X6S	680pF	±10%	50V	0.60
25	CSA0402X6S821K250GT	X6S	820pF	±10%	25V	0.60
26	CSA0402X6S821K500GT	X6S	820pF	±10%	50V	0.60
27	CSA0402X6S102K250GT	X6S	1.0nF	±10%	25V	0.60
28	CSA0402X6S102K500GT	X6S	1.0nF	±10%	50V	0.60
29	CSA0402X6S152K250GT	X6S	1.5nF	±10%	25V	0.60
30	CSA0402X6S152K500GT	X6S	1.5nF	±10%	50V	0.60
31	CSA0402X6S182K250GT	X6S	1.8nF	±10%	25V	0.60
32	CSA0402X6S182K500GT	X6S	1.8nF	±10%	50V	0.60
33	CSA0402X6S222K250GT	X6S	2.2nF	±10%	25V	0.60
34	CSA0402X6S222K500GT	X6S	2.2nF	±10%	50V	0.60
35	CSA0402X6S272K250GT	X6S	2.7nF	±10%	25V	0.60
36	CSA0402X6S272K500GT	X6S	2.7nF	±10%	50V	0.60
37	CSA0402X6S332K250GT	X6S	3.3nF	±10%	25V	0.60
38	CSA0402X6S332K500GT	X6S	3.3nF	±10%	50V	0.60
39	CSA0402X6S472K250GT	X6S	4.7nF	±10%	25V	0.60
40	CSA0402X6S472K500GT	X6S	4.7nF	±10%	50V	0.60
41	CSA0402X6S562K250GT	X6S	5.6nF	±10%	25V	0.60
42	CSA0402X6S562K500GT	X6S	5.6nF	±10%	50V	0.60
43	CSA0402X6S103K250GT	X6S	10nF	±10%	25V	0.60
44	CSA0402X6S103K500GT	X6S	10nF	±10%	50V	0.60
45	CSA0402X6S153K250GT	X6S	15nF	±10%	25V	0.60
46	CSA0402X6S153K500GT	X6S	15nF	±10%	50V	0.60
47	CSA0402X6S333K250GT	X6S	33nF	±10%	25V	0.60
48	CSA0402X6S333K500GT	X6S	33nF	±10%	50V	0.60
49	CSA0402X6S393K250GT	X6S	39nF	±10%	25V	0.60
50	CSA0402X6S393K500GT	X6S	39nF	±10%	50V	0.60
51	CSA0402X6S473K250GT	X6S	47nF	±10%	25V	0.60
52	CSA0402X6S473K500GT	X6S	47nF	±10%	50V	0.60
53	CSA0402X6S563K250GT	X6S	56nF	±10%	25V	0.60
54	CSA0402X6S563K500GT	X6S	56nF	±10%	50V	0.60
55	CSA0402X6S683K250GT	X6S	68nF	±10%	25V	0.60
56	CSA0402X6S683K500GT	X6S	68nF	±10%	50V	0.60

## X6S系列料号表

尺寸: 0402(公制: 1.0mmx0.5mm)

序号	HRE料号	材质	容值	容差	耐压	最大厚度 (mm)
57	CSA0402X6S104K160GT	X6S	100nF	±10%	16V	0.60
58	CSA0402X6S104K250GT	X6S	100nF	±10%	25V	0.60
59	CSA0402X6S104K500GT	X6S	100nF	±10%	50V	0.60
60	CSA0402X6S154K160GT	X6S	150nF	±10%	16V	0.60
61	CSA0402X6S154K250GT	X6S	150nF	±10%	25V	0.60
62	CSA0402X6S224K6R3GT	X6S	220nF	±10%	6.3V	0.60
63	CSA0402X6S224K100GT	X6S	220nF	±10%	10V	0.60
64	CSA0402X6S224K160GT	X6S	220nF	±10%	16V	0.60
65	CSA0402X6S274K6R3GT	X6S	270nF	±10%	6.3V	0.60
66	CSA0402X6S274K100GT	X6S	270nF	±10%	10V	0.60
67	CSA0402X6S274K160GT	X6S	270nF	±10%	16V	0.60
68	CSA0402X6S334K6R3GT	X6S	330nF	±10%	6.3V	0.60
69	CSA0402X6S334K100GT	X6S	330nF	±10%	10V	0.60
70	CSA0402X6S334K160GT	X6S	330nF	±10%	16V	0.60
71	CSA0402X6S474K6R3GT	X6S	470nF	±10%	6.3V	0.60
72	CSA0402X6S474K100GT	X6S	470nF	±10%	10V	0.60
73	CSA0402X6S474K160GT	X6S	470nF	±10%	16V	0.60
74	CSA0402X6S684K6R3GT	X6S	680nF	±10%	6.3V	0.60
75	CSA0402X6S684K100GT	X6S	680nF	±10%	10V	0.60
76	CSA0402X6S684K160GT	X6S	680nF	±10%	16V	0.60
77	CSA0402X6S105K6R3GT	X6S	1.0uF	±10%	6.3V	0.60
78	CSA0402X6S105K100GT	X6S	1.0uF	±10%	10V	0.60
79	CSA0402X6S225K6R3GT	X6S	2.2uF	±10%	6.3V	0.70

尺寸: 0603(公制: 1.6mmx0.8mm)

序号	HRE料号	材质	容值	容差	耐压	最大厚度 (mm)
1	CSA0603X6S221K500JT	X6S	220pF	±10%	±10%	0.90
2	CSA0603X6S271K500JT	X6S	270pF	±10%	±10%	0.90
3	CSA0603X6S331K500JT	X6S	330pF	±10%	±10%	0.90
4	CSA0603X6S391K500JT	X6S	390pF	±10%	±10%	0.90
5	CSA0603X6S471K500JT	X6S	470pF	±10%	±10%	0.90
6	CSA0603X6S561K500JT	X6S	560pF	±10%	±10%	0.90
7	CSA0603X6S681K500JT	X6S	680pF	±10%	±10%	0.90

## X6S系列料号表

尺寸: 0603(公制: 1.6mmx0.8mm)

序号	HRE料号	材质	容值	容差	耐压	最大厚度 (mm)
8	CSA0603X6S821K500JT	X6S	820pF	±10%	±10%	0.90
9	CSA0603X6S102K500JT	X6S	1.0nF	±10%	±10%	0.90
10	CSA0603X6S152K500JT	X6S	1.5nF	±10%	±10%	0.90
11	CSA0603X6S182K500JT	X6S	1.8nF	±10%	±10%	0.90
12	CSA0603X6S222K500JT	X6S	2.2nF	±10%	±10%	0.90
13	CSA0603X6S272K500JT	X6S	2.7nF	±10%	±10%	0.90
14	CSA0603X6S332K500JT	X6S	3.3nF	±10%	±10%	0.90
15	CSA0603X6S472K500JT	X6S	4.7nF	±10%	±10%	0.90
16	CSA0603X6S562K500JT	X6S	5.6nF	±10%	±10%	0.90
17	CSA0603X6S682K500JT	X6S	6.8nF	±10%	±10%	0.90
18	CSA0603X6S103K500JT	X6S	10nF	±10%	±10%	0.90
19	CSA0603X6S153K500JT	X6S	15nF	±10%	±10%	0.90
20	CSA0603X6S183K500JT	X6S	18nF	±10%	±10%	0.90
21	CSA0603X6S223K500JT	X6S	22nF	±10%	±10%	0.90
22	CSA0603X6S273K500JT	X6S	27nF	±10%	±10%	0.90
23	CSA0603X6S333K500JT	X6S	33nF	±10%	±10%	0.90
24	CSA0603X6S393K500JT	X6S	39nF	±10%	±10%	0.90
25	CSA0603X6S473K500JT	X6S	47nF	±10%	±10%	0.90
26	CSA0603X6S563K500JT	X6S	56nF	±10%	±10%	0.90
27	CSA0603X6S683K500JT	X6S	68nF	±10%	±10%	0.90
28	CSA0603X6S104K160JT	X6S	100nF	±10%	±10%	0.90
29	CSA0603X6S104K250JT	X6S	100nF	±10%	±10%	0.90
30	CSA0603X6S104K500JT	X6S	100nF	±10%	±10%	0.90
31	CSA0603X6S154K160JT	X6S	150nF	±10%	±10%	0.90
32	CSA0603X6S154K250JT	X6S	150nF	±10%	±10%	0.90
33	CSA0603X6S154K500JT	X6S	150nF	±10%	±10%	1.00
34	CSA0603X6S184K160JT	X6S	180nF	±10%	±10%	0.90
35	CSA0603X6S184K250JT	X6S	180nF	±10%	±10%	0.90
36	CSA0603X6S184K500JT	X6S	180nF	±10%	±10%	1.00
37	CSA0603X6S224K6R3JT	X6S	220nF	±10%	±10%	0.90
38	CSA0603X6S224K100JT	X6S	220nF	±10%	10V	0.90
39	CSA0603X6S224K160JT	X6S	220nF	±10%	16V	0.90
40	CSA0603X6S224K250JT	X6S	220nF	±10%	25V	0.90
41	CSA0603X6S224K500JT	X6S	220nF	±10%	50V	1.00
42	CSA0603X6S274K6R3JT	X6S	270nF	±10%	6.3V	0.90



## X6S系列料号表

尺寸: 0603(公制: 1.6mmx0.8mm)

序号	HRE料号	材质	容值	容差	耐压	最大厚度 (mm)
43	CSA0603X6S274K100JT	X6S	270nF	±10%	10V	0.90
44	CSA0603X6S274K160JT	X6S	270nF	±10%	16V	0.90
45	CSA0603X6S274K250JT	X6S	270nF	±10%	25V	1.00
46	CSA0603X6S274K500JT	X6S	270nF	±10%	50V	1.00
47	CSA0603X6S334K6R3JT	X6S	330nF	±10%	6.3V	0.90
48	CSA0603X6S334K100JT	X6S	330nF	±10%	10V	0.90
49	CSA0603X6S334K160JT	X6S	330nF	±10%	16V	0.90
50	CSA0603X6S334K250JT	X6S	330nF	±10%	25V	1.00
51	CSA0603X6S334K500JT	X6S	330nF	±10%	50V	1.00
52	CSA0603X6S474K6R3JT	X6S	470nF	±10%	6.3V	0.90
53	CSA0603X6S474K100JT	X6S	470nF	±10%	10V	0.90
54	CSA0603X6S474K160JT	X6S	470nF	±10%	16V	0.90
55	CSA0603X6S474K250JT	X6S	470nF	±10%	25V	1.00
56	CSA0603X6S474K500JT	X6S	470nF	±10%	50V	1.00
57	CSA0603X6S684K6R3JT	X6S	680nF	±10%	6.3V	0.90
58	CSA0603X6S684K100JT	X6S	680nF	±10%	10V	0.90
59	CSA0603X6S684K160JT	X6S	680nF	±10%	16V	0.90
60	CSA0603X6S684K250JT	X6S	680nF	±10%	25V	1.00
61	CSA0603X6S684K500JT	X6S	680nF	±10%	50V	1.00
62	CSA0603X6S105K6R3JT	X6S	1.0uF	±10%	6.3V	0.90
63	CSA0603X6S105K100JT	X6S	1.0uF	±10%	10V	0.90
64	CSA0603X6S105K160JT	X6S	1.0uF	±10%	16V	0.90
65	CSA0603X6S105K250JT	X6S	1.0uF	±10%	25V	1.00
66	CSA0603X6S105K500JT	X6S	1.0uF	±10%	50V	1.00
67	CSA0603X6S225K6R3JT	X6S	2.2uF	±10%	6.3V	0.90
68	CSA0603X6S225K100JT	X6S	2.2uF	±10%	10V	0.90
69	CSA0603X6S225K160JT	X6S	2.2uF	±10%	16V	1.00
70	CSA0603X6S225K250JT	X6S	2.2uF	±10%	25V	1.00
71	CSA0603X6S475K6R3JT	X6S	4.7uF	±10%	6.3V	1.00
72	CSA0603X6S475K100JT	X6S	4.7uF	±10%	10V	1.00
73	CSA0603X6S475K160JT	X6S	4.7uF	±10%	16V	1.00
74	CSA0603X6S475K250JT	X6S	4.7uF	±10%	25V	1.00
75	CSA0603X6S106M6R3JT	X6S	10uF	±20%	6.3V	1.00
76	CSA0603X6S106M100JT	X6S	10uF	±20%	10V	1.00
77	CSA0603X6S106M160JT	X6S	10uF	±20%	16V	1.00

## X6S系列料号表

尺寸：0805(公制：2.0mmx1.25mm)

序号	HRE料号	材质	容值	容差	耐压	最大厚度 (mm)
1	CSA0805X6S103K500KT	X6S	10nF	±10%	50V	0.95
2	CSA0805X6S153K500KT	X6S	15nF	±10%	50V	0.95
3	CSA0805X6S183K500KT	X6S	18nF	±10%	50V	0.95
4	CSA0805X6S223K500KT	X6S	22nF	±10%	50V	0.95
5	CSA0805X6S273K500KT	X6S	27nF	±10%	50V	0.95
6	CSA0805X6S333K500KT	X6S	33nF	±10%	50V	0.95
7	CSA0805X6S393K500KT	X6S	39nF	±10%	50V	0.95
8	CSA0805X6S473K500KT	X6S	47nF	±10%	50V	0.95
9	CSA0805X6S563K500KT	X6S	56nF	±10%	50V	0.95
10	CSA0805X6S683K500KT	X6S	68nF	±10%	50V	0.95
11	CSA0805X6S104K500KT	X6S	100nF	±10%	50V	0.95
12	CSA0805X6S154K500KT	X6S	150nF	±10%	50V	0.95
13	CSA0805X6S184K500KT	X6S	180nF	±10%	50V	0.95
14	CSA0805X6S224K160KT	X6S	220nF	±10%	16V	0.95
15	CSA0805X6S224K250KT	X6S	220nF	±10%	25V	0.95
16	CSA0805X6S224K500MT	X6S	220nF	±10%	50V	1.45
17	CSA0805X6S274K160KT	X6S	270nF	±10%	16V	0.95
18	CSA0805X6S274K250KT	X6S	270nF	±10%	25V	0.95
19	CSA0805X6S274K500MT	X6S	270nF	±10%	50V	1.45
20	CSA0805X6S334K160KT	X6S	330nF	±10%	16V	0.95
21	CSA0805X6S334K250KT	X6S	330nF	±10%	25V	0.95
22	CSA0805X6S334K500MT	X6S	330nF	±10%	50V	1.45
23	CSA0805X6S474K100KT	X6S	470nF	±10%	6.3V	0.95
24	CSA0805X6S474K100KT	X6S	470nF	±10%	10V	0.95
25	CSA0805X6S474K160MT	X6S	470nF	±10%	16V	1.45
26	CSA0805X6S474K250MT	X6S	470nF	±10%	25V	1.45
27	CSA0805X6S474K500MT	X6S	470nF	±10%	50V	1.45
28	CSA0805X6S684K100KT	X6S	680nF	±10%	6.3V	0.95
29	CSA0805X6S684K100KT	X6S	680nF	±10%	10V	0.95
30	CSA0805X6S684K160MT	X6S	680nF	±10%	16V	1.45
31	CSA0805X6S684K250MT	X6S	680nF	±10%	25V	1.45
32	CSA0805X6S684K500KT	X6S	680nF	±10%	50V	1.45
33	CSA0805X6S105K100KT	X6S	1.0uF	±10%	6.3V	0.95
34	CSA0805X6S105K100KT	X6S	1.0uF	±10%	10V	0.95
35	CSA0805X6S105K160MT	X6S	1.0uF	±10%	16V	1.45

## X6S系列料号表

尺寸: 0805(公制: 2.0mmx1.25mm)

序号	HRE料号	材质	容值	容差	耐压	最大厚度 (mm)
36	CSA0805X6S105K250MT	X6S	1.0uF	±10%	25V	1.45
37	CSA0805X6S105K500MT	X6S	1.0uF	±10%	50V	1.45
38	CSA0805X6S225K100MT	X6S	2.2uF	±10%	6.3V	1.45
39	CSA0805X6S225K100MT	X6S	2.2uF	±10%	10V	1.45
40	CSA0805X6S225K160MT	X6S	2.2uF	±10%	16V	1.45
41	CSA0805X6S225K250MT	X6S	2.2uF	±10%	25V	1.45
42	CSA0805X6S475K100MT	X6S	4.7uF	±10%	6.3V	1.45
43	CSA0805X6S475K100MT	X6S	4.7uF	±10%	10V	1.45
44	CSA0805X6S475K160MT	X6S	4.7uF	±10%	16V	1.45
45	CSA0805X6S475K250MT	X6S	4.7uF	±10%	25V	1.45
46	CSA0805X6S106M100MT	X6S	10uF	±20%	6.3V	1.45
47	CSA0805X6S106M100MT	X6S	10uF	±20%	10V	1.45
48	CSA0805X6S106M160MT	X6S	10uF	±20%	16V	1.45
49	CSA0805X6S106M250MT	X6S	10uF	±20%	25V	1.45
50	CSA0805X6S226M100MT	X6S	22uF	±20%	6.3V	1.45

尺寸: 1206(公制: 3.2mmx1.6mm)

序号	HRE料号	材质	容值	容差	耐压	最大厚度 (mm)
1	CSA1206X6S103K500KT	X6S	10nF	±10%	50V	0.95
2	CSA1206X6S153K500KT	X6S	15nF	±10%	50V	0.95
3	CSA1206X6S183K500KT	X6S	18nF	±10%	50V	0.95
4	CSA1206X6S223K500KT	X6S	22nF	±10%	50V	0.95
5	CSA1206X6S273K500KT	X6S	27nF	±10%	50V	0.95
6	CSA1206X6S333K500KT	X6S	33nF	±10%	50V	0.95
7	CSA1206X6S393K500KT	X6S	39nF	±10%	50V	0.95
8	CSA1206X6S473K500KT	X6S	47nF	±10%	50V	0.95
9	CSA1206X6S563K500KT	X6S	56nF	±10%	50V	0.95
10	CSA1206X6S683K500KT	X6S	68nF	±10%	50V	0.95
11	CSA1206X6S104K500KT	X6S	100nF	±10%	50V	0.95
12	CSA1206X6S154K500KT	X6S	150nF	±10%	50V	0.95
13	CSA1206X6S184K500KT	X6S	180nF	±10%	50V	0.95
14	CSA1206X6S224K160KT	X6S	220nF	±10%	16V	0.95
15	CSA1206X6S224K250KT	X6S	220nF	±10%	25V	0.95

## X6S系列料号表

尺寸: 1206(公制: 3.2mmx1.6mm)

序号	HRE料号	材质	容值	容差	耐压	最大厚度 (mm)
16	CSA1206X6S224K500KT	X6S	220nF	±10%	50V	0.95
17	CSA1206X6S274K160KT	X6S	270nF	±10%	16V	0.95
18	CSA1206X6S274K250KT	X6S	270nF	±10%	25V	0.95
19	CSA1206X6S274K500KT	X6S	270nF	±10%	50V	0.95
20	CSA1206X6S334K160KT	X6S	330nF	±10%	16V	0.95
21	CSA1206X6S334K250KT	X6S	330nF	±10%	25V	0.95
22	CSA1206X6S334K500KT	X6S	330nF	±10%	50V	0.95
23	CSA1206X6S474K6R3MT	X6S	470nF	±10%	6.3V	1.45
24	CSA1206X6S474K100MT	X6S	470nF	±10%	10V	1.45
25	CSA1206X6S474K160MT	X6S	470nF	±10%	16V	1.45
26	CSA1206X6S474K250MT	X6S	470nF	±10%	25V	1.45
27	CSA1206X6S474K500MT	X6S	470nF	±10%	50V	1.45
28	CSA1206X6S684K6R3MT	X6S	680nF	±10%	6.3V	1.45
29	CSA1206X6S684K100MT	X6S	680nF	±10%	10V	1.45
30	CSA1206X6S684K160MT	X6S	680nF	±10%	16V	1.45
31	CSA1206X6S684K250MT	X6S	680nF	±10%	25V	1.45
32	CSA1206X6S684K500NT	X6S	680nF	±10%	50V	1.80
33	CSA1206X6S105K6R3MT	X6S	1.0uF	±10%	6.3V	1.45
34	CSA1206X6S105K100MT	X6S	1.0uF	±10%	10V	1.45
35	CSA1206X6S105K160MT	X6S	1.0uF	±10%	16V	1.45
36	CSA1206X6S105K250MT	X6S	1.0uF	±10%	25V	1.45
37	CSA1206X6S105K500NT	X6S	1.0uF	±10%	50V	1.80
38	CSA1206X6S225K6R3MT	X6S	2.2uF	±10%	6.3V	1.45
39	CSA1206X6S225K100MT	X6S	2.2uF	±10%	10V	1.45
40	CSA1206X6S225K160MT	X6S	2.2uF	±10%	16V	1.45
41	CSA1206X6S225K250MT	X6S	2.2uF	±10%	25V	1.45
42	CSA1206X6S225K500NT	X6S	2.2uF	±10%	50V	1.80
43	CSA1206X6S475K6R3NT	X6S	4.7uF	±10%	6.3V	1.90
44	CSA1206X6S475K100NT	X6S	4.7uF	±10%	10V	1.90
45	CSA1206X6S475K160NT	X6S	4.7uF	±10%	16V	1.90
46	CSA1206X6S475K250NT	X6S	4.7uF	±10%	25V	1.90
47	CSA1206X6S475K500NT	X6S	4.7uF	±10%	50V	1.90
48	CSA1206X6S106M6R3NT	X6S	10uF	±20%	6.3V	1.90
49	CSA1206X6S106M100NT	X6S	10uF	±20%	10V	1.90
50	CSA1206X6S106M160NT	X6S	10uF	±20%	16V	1.90

## X6S系列料号表

尺寸: 1206(公制: 3.2mmx1.6mm)

序号	HRE料号	材质	容值	容差	耐压	最大厚度 (mm)
51	CSA1206X6S106M250NT	X6S	10uF	±20%	25V	1.90
52	CSA1206X6S226M6R3NT	X6S	22uF	±20%	6.3V	1.90
53	CSA1206X6S226M100NT	X6S	22uF	±20%	10V	1.90
54	CSA1206X6S226M160NT	X6S	22uF	±20%	16V	1.90
55	CSA1206X6S226M250NT	X6S	22uF	±20%	25V	1.90
56	CSA1206X6S476M6R3NT	X6S	47uF	±20%	6.3V	1.90

尺寸: 1210(公制: 3.2mmx2.5mm)

序号	HRE料号	材质	容值	容差	耐压	最大厚度 (mm)
1	CSA1210X6S474K6R3QT	X6S	470nF	±10%	6.3V	2.20
2	CSA1210X6S474K100QT	X6S	470nF	±10%	10V	2.20
3	CSA1210X6S474K160QT	X6S	470nF	±10%	16V	2.20
4	CSA1210X6S474K250QT	X6S	470nF	±10%	25V	2.20
5	CSA1210X6S474K500QT	X6S	470nF	±10%	50V	2.20
6	CSA1210X6S684K6R3NT	X6S	680nF	±10%	6.3V	1.80
7	CSA1210X6S684K100NT	X6S	680nF	±10%	10V	1.80
8	CSA1210X6S684K160NT	X6S	680nF	±10%	16V	1.80
9	CSA1210X6S684K250NT	X6S	680nF	±10%	25V	1.80
10	CSA1210X6S684K500NT	X6S	680nF	±10%	50V	1.80
11	CSA1210X6S105K6R3NT	X6S	1.0uF	±10%	6.3V	1.80
12	CSA1210X6S105K100NT	X6S	1.0uF	±10%	10V	1.80
13	CSA1210X6S105K160NT	X6S	1.0uF	±10%	16V	1.80
14	CSA1210X6S105K250NT	X6S	1.0uF	±10%	25V	1.80
15	CSA1210X6S105K500NT	X6S	1.0uF	±10%	50V	1.80
16	CSA1210X6S225K6R3NT	X6S	2.2uF	±10%	6.3V	1.80
17	CSA1210X6S225K100NT	X6S	2.2uF	±10%	10V	1.80
18	CSA1210X6S225K160NT	X6S	2.2uF	±10%	16V	1.80
19	CSA1210X6S225K250NT	X6S	2.2uF	±10%	25V	1.80
20	CSA1210X6S225K500NT	X6S	2.2uF	±10%	50V	1.80
21	CSA1210X6S475K6R3NT	X6S	4.7uF	±10%	6.3V	1.80
22	CSA1210X6S475K100NT	X6S	4.7uF	±10%	10V	1.80
23	CSA1210X6S475K160NT	X6S	4.7uF	±10%	16V	1.80
24	CSA1210X6S475K250NT	X6S	4.7uF	±10%	25V	2.20
25	CSA1210X6S475K500RT	X6S	4.7uF	±10%	50V	2.80

## X6S系列料号表

尺寸: 1210(公制: 3.2mmx2.5mm)

序号	HRE料号	材质	容值	容差	耐压	最大厚度 (mm)
26	CSA1210X6S106K6R3RT	X6S	10uF	±10%	6.3V	2.80
27	CSA1210X6S106K100RT	X6S	10uF	±10%	10V	2.80
28	CSA1210X6S106K160QT	X6S	10uF	±10%	16V	2.20
29	CSA1210X6S106K250RT	X6S	10uF	±10%	25V	2.80
30	CSA1210X6S106M500RT	X6S	10uF	±20%	50V	2.80
31	CSA1210X6S226K6R3RT	X6S	22uF	±10%	6.3V	2.80
32	CSA1210X6S226K100RT	X6S	22uF	±10%	10V	2.80
33	CSA1210X6S226M160RT	X6S	22uF	±20%	16V	2.80
34	CSA1210X6S226M250RT	X6S	22uF	±20%	25V	2.80
35	CSA1210X6S476M6R3RT	X6S	47uF	±20%	6.3V	2.80
36	CSA1210X6S476M100RT	X6S	47uF	±20%	10V	2.80
37	CSA1210X6S107M6R3RT	X6S	100uF	±20%	6.3V	2.80

## 工业级电容--Level I

### 特性

工业级--Level I 电容 (MLCC) 是一种使用于工业应用的贴片电容。在一般常规电容 (MLCC) 性能的基础上, 提高了产品的防潮性能和更高的可靠性。

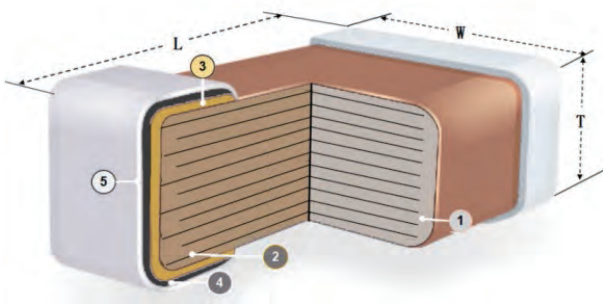

序号	名称
1	陶瓷介质
2	内电极
3	外电极
4	镍层
5	锡层

### 增强可靠度

可靠度项目	一般常规电容 (含中高压)	工业级-Level I	工业级-Level II
高温高湿	40°C 95%RH 1Vr 500h	65°C 95%RH 1Vr 500h	85°C 85%RH 1Vr 1000h
高温加载	高温 1.5Vr 1000h	高温 1.5Vr 1000h	高温 1.5Vr 1000h
抗弯曲力	1mm	1mm	2mm
冷热冲击	5个循环	5个循环	1000个循环

### 应用

服务器, 网络, 基站, 太阳能逆变器, DC-DC转换器等。

### COG系列容值范围表

产品等级	材质	尺寸 (inch)	电压 (Vdc)	pF			nF			uF			容值范围	
				0.1	1	10	100	1	10	100	1	10		100
工业级 Level I	COG 125°C	0201	25				100						100pF~100pF	
			50				33	47						33pF~47pF
		0402	50	0.5	1	10							0.5pF~1nF	
		0603	25					680	1500					680pF~1.5nF
			50	1	10	100								1pF~2.2nF
			100				10	330						10pF~330pF
		0805	50	33	10									33pF~10nF
			100				330	1						330pF~1nF
			200						220					220pF
			250				10							10pF
		1206	25							10				10nF
			50							1.5	33			1.5nF~33nF
			100								1			1nF
			500				10	39						10pF~39pF
			630										220	220pF
		1210	100									47	47nF	



### X7R系列容值范围表

产品等级	材质	尺寸 (inch)	电压 (Vdc)	pF			nF			uF			容值范围	
				0.1	1	10	100	1	10	100	1	10		100
工业级 Level I	X7R 125°C	0201	10										10nF~10nF	
			16										1nF~10nF	
			25											680pF~1nF
		0402	6.3											220nF~1uF
			10											27nF~220nF
			16											1nF~220nF
			25											1nF~220nF
		0603	50											220nF~100nF
			10											220nF~1uF
			16											100nF~1uF
			25											39nF~1uF
			50											100pF~220nF
		0805	100											1nF~100nF
			6.3											10uF~10uF
			10											2.2uF~10uF
			16											2.2uF~4.7uF
			25											100nF~2.2uF
			50											1nF~2.2uF
		1206	100											10nF~10nF
			6.3											22uF~22uF
			10											22uF~22uF
			16											1uF~2.2uF
			25											1uF~2.2uF
			50											100nF~2.2uF
100												2.2uF~2.2uF		
630												10nF~10nF		
1210	25											10uF~10uF		
	50											4.7uF~10uF		
	100											4.7uF~4.7uF		
	630											47nF~47nF		
	1000											22nF~22nF		

### X5R系列容值范围表

产品等级	材质	尺寸 (inch)	电压 (Vdc)	pF			nF			uF			容值范围	
				0.1	1	10	100	1	10	100	1	10		100
工业级 Level I	X5R 85°C	0201	6.3										10nF~470nF	
			10										2.2nF~100nF	
		0402	4											2.2uF~4.7uF
			6.3											220nF~4.7uF
			10											100nF~1uF
			16											100nF~1uF
		0603	25											100nF~1uF
			4											10uF~47uF
			6.3											2.2uF~10uF
			10											470nF~4.7uF
			16											1uF~2.2uF
		0805	25											220nF~1uF
			4											47uF~47uF
			6.3											4.7uF~47uF
			10											2.2uF~22uF
			16											10uF~22uF
		1206	25											2.2uF~22uF
			6.3											22uF~100uF
			10											22uF~47uF
			16											22uF~22uF
		1210	25											4.7uF~22uF
			6.3											22uF~100uF
			10											22uF~22uF
			16											22uF~47uF
		25										22uF~22uF		

### X6S系列容值范围表

产品等级	材质	尺寸 (inch)	电压 (Vdc)	pF			nF			uF			容值范围	
				0.1	1	10	100	1	10	100	1	10		100
工业级 Level I	X6S 105°C	0201	6.3							■			100nF~100nF	
			16							■			100nF~100nF	
		0402	6.3								■			470nF~1uF
			10								■			1uF~2.2uF
			25								■			1uF~1uF
		0603	2.5										■	47uF~47uF
			4									■		4.7uF~47uF
			6.3									■		4.7uF~22uF
			10									■		10uF~10uF
			16									■		4.7uF~4.7uF
		0805	4										■	22uF~47uF
			6.3										■	10uF~22uF
			10										■	22uF~22uF
		1206	16										■	10uF~22uF
			4										■	100uF~100uF
			6.3										■	47uF~47uF
		1210	6.3										■	100uF~100uF

### COG系列料号表

尺寸: 0201(公制: 0.6mmx0.3mm)

序号	HRE料号	材质	容值	容差	耐压	最大厚度 (mm)
1	CIA0201COG100J250ET	COG	10pF	±5%	25	0.33
2	CIA0201COG330J250ET	COG	33pF	±5%	25	0.33
3	CIA0201COG330J500ET	COG	33pF	±5%	50	0.33
4	CIA0201COG470J500ET	COG	47pF	±5%	50	0.33
5	CIA0201COG101J250ET	COG	100pF	±5%	25	0.33

尺寸: 0402(公制: 1.0mmx0.5mm)

序号	HRE料号	材质	容值	容差	耐压	最大厚度 (mm)
1	CIA0402COG0R5C500GT	COG	0.5pF	±0.25pF	50V	0.55
2	CIA0402COGR75C500GT	COG	0.75pF	±0.25pF	50V	0.55
3	CIA0402COG1R3C500GT	COG	1.3pF	±0.25pF	50V	0.55
4	CIA0402COG2R0C500GT	COG	2.0pF	±0.25pF	50V	0.55
5	CIA0402COG2R2C500GT	COG	2.2pF	±0.25pF	50V	0.55
6	CIA0402COG2R4B500GT	COG	2.4pF	±0.10pF	50V	0.55
7	CIA0402COG4R0C500GT	COG	4.0pF	±0.25pF	50V	0.55
8	CIA0402COG4R3C500GT	COG	4.3pF	±0.25pF	50V	0.55
9	CIA0402COG4R7C500GT	COG	4.7pF	±0.25pF	50V	0.55
10	CIA0402COG5R6C500GT	COG	5.6pF	±0.25pF	50V	0.55
11	CIA0402COG8R2C500GT	COG	8.2pF	±0.25pF	50V	0.55
12	CIA0402COG9R0C500GT	COG	9.0pF	±0.25pF	50V	0.55
13	CIA0402COG100J500GT	COG	10pF	±5%	50V	0.55
14	CIA0402COG120C500GT	COG	12pF	±0.25pF	50V	0.55
15	CIA0402COG150C500GT	COG	15pF	±0.25pF	50V	0.55
16	CIA0402COG150J500GT	COG	15pF	±5%	50V	0.55
17	CIA0402COG180J500GT	COG	18pF	±5%	50V	0.55
18	CIA0402COG200J500GT	COG	20pF	±5%	50V	0.55
19	CIA0402COG220J500GT	COG	22pF	±5%	50V	0.55
20	CIA0402COG240J500GT	COG	24pF	±5%	50V	0.55
21	CIA0402COG270J500GT	COG	27pF	±5%	50V	0.55
22	CIA0402COG330J500GT	COG	33pF	±5%	50V	0.55
23	CIA0402COG390J500GT	COG	39pF	±5%	50V	0.55
24	CIA0402COG470J500GT	COG	47pF	±5%	50V	0.55
25	CIA0402COG560J500GT	COG	56pF	±5%	50V	0.55
26	CIA0402COG680J500GT	COG	68pF	±5%	50V	0.55

### COG系列料号表

尺寸: 0402(公制: 1.0mmx0.5mm)

序号	HRE料号	材质	容值	容差	耐压	最大厚度 (mm)
27	CIA0402COG820J500GT	COG	82pF	±5%	50V	0.55
28	CIA0402COG101J500GT	COG	100pF	±5%	50V	0.55
29	CIA0402COG151J500GT	COG	150pF	±5%	50V	0.55
30	CIA0402COG181J500GT	COG	180pF	±5%	50V	0.55
31	CIA0402COG221J500GT	COG	220pF	±5%	50V	0.55
32	CIA0402COG271J500GT	COG	270pF	±5%	50V	0.55
33	CIA0402COG331J500GT	COG	330pF	±5%	50V	0.55
34	CIA0402COG391J500GT	COG	390pF	±5%	50V	0.55
35	CIA0402COG471J500GT	COG	470pF	±5%	50V	0.55
36	CIA0402COG561J500GT	COG	560pF	±5%	50V	0.55
37	CIA0402COG681J500GT	COG	680pF	±5%	50V	0.55
38	CIA0402COG821J500GT	COG	820pF	±5%	50V	0.55
39	CIA0402COG102J500GT	COG	1nF	±5%	50V	0.55

尺寸: 0603(公制: 1.6mmx0.8mm)

序号	HRE料号	材质	容值	容差	耐压	最大厚度 (mm)
1	CIA0603COG1R0C500JT	COG	1.0pF	±0.25pF	50V	0.90
2	CIA0603COG1R8C500JT	COG	1.8pF	±0.25pF	50V	0.90
3	CIA0603COG2R2C500JT	COG	2.2pF	±0.25pF	50V	0.90
4	CIA0603COG3R3C500JT	COG	3.3pF	±0.25pF	50V	0.90
5	CIA0603COG3R9B500JT	COG	3.9pF	±0.10pF	50V	0.90
6	CIA0603COG3R9C500JT	COG	3.9pF	±0.25pF	50V	0.90
7	CIA0603COG4R7B500JT	COG	4.7pF	±0.10pF	50V	0.90
8	CIA0603COG4R7C500JT	COG	4.7pF	±0.25pF	50V	0.90
9	CIA0603COG050B500JT	COG	5.0pF	±0.10pF	50V	0.90
10	CIA0603COG5R6C500JT	COG	5.6pF	±0.25pF	50V	0.90
11	CIA0603COG6R2C500JT	COG	6.2pF	±0.25pF	50V	0.90
12	CIA0603COG6R8C500JT	COG	6.8pF	±0.25pF	50V	0.90
13	CIA0603COG8R2C500JT	COG	8.2pF	±0.25pF	50V	0.90
14	CIA0603COG100C500JT	COG	10pF	±0.25pF	50V	0.90
15	CIA0603COG100J500JT	COG	10pF	±5%	50V	0.90
16	CIA0603COG100J101JT	COG	10pF	±5%	100V	0.90
17	CIA0603COG120J500JT	COG	12pF	±5%	50V	0.90
18	CIA0603COG150J500JT	COG	15pF	±5%	50V	0.90
19	CIA0603COG180J500JT	COG	18pF	±5%	50V	0.90

### C0G系列料号表

尺寸: 0603(公制: 1.6mmx0.8mm)

序号	HRE料号	材质	容值	容差	耐压	最大厚度 (mm)
20	CIA0603C0G220J500JT	C0G	22pF	±5%	50V	0.90
21	CIA0603C0G270J500JT	C0G	27pF	±5%	50V	0.90
22	CIA0603C0G330J500JT	C0G	33pF	±5%	50V	0.90
23	CIA0603C0G330J101JT	C0G	33pF	±5%	100V	0.90
24	CIA0603C0G390J500JT	C0G	39pF	±5%	50V	0.90
25	CIA0603C0G470J500JT	C0G	47pF	±5%	50V	0.90
26	CIA0603C0G560J500JT	C0G	56pF	±5%	50V	0.90
27	CIA0603C0G680J500JT	C0G	68pF	±5%	50V	0.90
28	CIA0603C0G820J500JT	C0G	82pF	±5%	50V	0.90
29	CIA0603C0G101J500JT	C0G	100pF	±5%	50V	0.90
30	CIA0603C0G101J101JT	C0G	100pF	±5%	100V	0.90
31	CIA0603C0G121J500JT	C0G	120pF	±5%	50V	0.90
32	CIA0603C0G151J101JT	C0G	150pF	±5%	100V	0.90
33	CIA0603C0G201J500JT	C0G	200pF	±5%	50V	0.90
34	CIA0603C0G221J500JT	C0G	220pF	±5%	50V	0.90
35	CIA0603C0G221J101JT	C0G	220pF	±5%	100V	0.90
36	CIA0603C0G271J101JT	C0G	270pF	±5%	100V	0.90
37	CIA0603C0G331J500JT	C0G	330pF	±5%	50V	0.90
38	CIA0603C0G331J101JT	C0G	330pF	±5%	100V	0.90
39	CIA0603C0G471J500JT	C0G	470pF	±5%	50V	0.90
40	CIA0603C0G681J500JT	C0G	680pF	±5%	50V	0.90
41	CIA0603C0G102J500JT	C0G	1nF	±5%	50V	0.90
42	CIA0603C0G122J500JT	C0G	1.2nF	±5%	50V	0.90
43	CIA0603C0G152G500JT	C0G	1.5nF	±2%	50V	0.90
44	CIA0603C0G152J500JT	C0G	1.5nF	±5%	50V	0.90
45	CIA0603C0G222J500JT	C0G	2.2nF	±5%	50V	0.90

尺寸: 0805(公制: 2.0mmx1.25mm)

序号	HRE料号	材质	容值	容差	耐压	最大厚度 (mm)
1	CIA0805C0G100J251KT	C0G	10pF	±5%	250V	0.95
2	CIA0805C0G330J500KT	C0G	33pF	±5%	50V	0.75
3	CIA0805C0G101J500KT	C0G	100pF	±5%	50V	0.75
4	CIA0805C0G221J500KT	C0G	220pF	±5%	50V	0.75
5	CIA0805C0G221J201KT	C0G	220pF	±5%	200V	0.95
6	CIA0805C0G331J101KT	C0G	330pF	±5%	100V	0.75

## C0G系列料号表

尺寸: 0805(公制: 2.0mmx1.25mm)

序号	HRE料号	材质	容值	容差	耐压	最大厚度 (mm)
7	CIA0805C0G471J101KT	C0G	470pF	±5%	100	0.95
8	CIA0805C0G681J500KT	C0G	680pF	±5%	50	0.95
9	CIA0805C0G102J500KT	C0G	1.0nF	±5%	50	0.95
10	CIA0805C0G102J101MT	C0G	1.0nF	±5%	100	1.35
11	CIA0805C0G222J500MT	C0G	2.2nF	±5%	50	1.35
12	CIA0805C0G272J500MT	C0G	2.7nF	±5%	50	1.35
13	CIA0805C0G472J500MT	C0G	4.7nF	±5%	50	1.35
14	CIA0805C0G103J500MT	C0G	10nF	±5%	50	1.35

尺寸: 1206(公制: 3.2mmx1.6mm)

序号	HRE料号	材质	容值	容差	耐压	最大厚度 (mm)
1	CIA1206C0G100J500MT	C0G	10pF	±5%	500V	1.40
2	CIA1206C0G390J500MT	C0G	39pF	±5%	500V	1.40
3	CIA1206C0G221J500MT	C0G	220pF	±5%	630V	1.40
4	CIA1206C0G102K500MT	C0G	1.0nF	±10%	100V	1.00
5	CIA1206C0G152G500MT	C0G	1.5nF	±2%	50V	1.00
6	CIA1206C0G332J500MT	C0G	3.3nF	±5%	50V	1.40
7	CIA1206C0G103G500MT	C0G	10nF	±2%	25V	1.40
8	CIA1206C0G273J500NT	C0G	27nF	±5%	50V	1.80
9	CIA1206C0G333J500NT	C0G	33nF	±5%	50V	1.80

尺寸: 1210(公制: 3.2mmx2.5mm)

序号	HRE料号	材质	容值	容差	耐压	最大厚度 (mm)
1	CIA1210C0G473J500RT	C0G	47nF	±5%	100V	2.70

### X7R系列料号表

尺寸: 0201(公制: 0.6mmx0.3mm)

序号	HRE料号	材质	容值	容差	耐压	最大厚度 (mm)
1	CIA0201X7R681K250ET	X7R	680pF	±10%	25V	0.33
2	CIA0201X7R102K160ET	X7R	1nF	±10%	16V	0.33
3	CIA0201X7R102K250ET	X7R	1nF	±10%	25V	0.33
4	CIA0201X7R103K100ET	X7R	10nF	±10%	10V	0.33
5	CIA0201X7R103K160ET	X7R	10nF	±10%	16V	0.33

尺寸: 0402(公制: 1.0mmx0.5mm)

序号	HRE料号	材质	容值	容差	耐压	最大厚度 (mm)
1	CIA0402X7R221K500GT	X7R	220pF	±10%	50V	0.55
2	CIA0402X7R271K500GT	X7R	270pF	±10%	50V	0.55
3	CIA0402X7R331K500GT	X7R	330pF	±10%	50V	0.55
4	CIA0402X7R391K500GT	X7R	390pF	±10%	50V	0.55
5	CIA0402X7R471K500GT	X7R	470pF	±10%	50V	0.55
6	CIA0402X7R561K500GT	X7R	560pF	±10%	50V	0.55
7	CIA0402X7R681K500GT	X7R	680pF	±10%	50V	0.55
8	CIA0402X7R102K160GT	X7R	1nF	±10%	10V	0.55
9	CIA0402X7R102K250GT	X7R	1.0nF	±10%	25V	0.55
10	CIA0402X7R102K500GT	X7R	1.0nF	±10%	50V	0.55
11	CIA0402X7R152K500GT	X7R	1.5nF	±10%	50V	0.55
12	CIA0402X7R182K500GT	X7R	1.8nF	±10%	50V	0.55
13	CIA0402X7R222K500GT	X7R	2.2nF	±10%	50V	0.55
14	CIA0402X7R272K500GT	X7R	2.7nF	±10%	50V	0.55
15	CIA0402X7R332K500GT	X7R	3.3nF	±10%	50V	0.55
16	CIA0402X7R392K500GT	X7R	3.9nF	±10%	50V	0.55
17	CIA0402X7R472K500GT	X7R	4.7nF	±10%	50V	0.55
18	CIA0402X7R562K250GT	X7R	5.6nF	±10%	25V	0.55
19	CIA0402X7R682K250GT	X7R	6.8nF	±10%	25V	0.55
20	CIA0402X7R822K500GT	X7R	8.2nF	±10%	50V	0.55
21	CIA0402X7R103K160GT	X7R	10nF	±10%	16V	0.55
22	CIA0402X7R103K250GT	X7R	10nF	±10%	25V	0.55
23	CIA0402X7R103K500GT	X7R	10nF	±10%	50V	0.55
24	CIA0402X7R153K160GT	X7R	15nF	±10%	16V	0.55
25	CIA0402X7R153K250GT	X7R	15nF	±10%	25V	0.55
26	CIA0402X7R223K160GT	X7R	22nF	±10%	16V	0.55



### X7R系列料号表

尺寸: 0402(公制: 1.0mmx0.5mm)

序号	HRE料号	材质	容值	容差	耐压	最大厚度 (mm)
27	CIA0402X7R223K250GT	X7R	22nF	±10%	25V	0.55
28	CIA0402X7R223K500GT	X7R	22nF	±10%	50V	0.55
29	CIA0402X7R273K100GT	X7R	27nF	±10%	10V	0.55
30	CIA0402X7R333K100GT	X7R	33nF	±10%	10V	0.55
31	CIA0402X7R333K160GT	X7R	33nF	±10%	16V	0.55
32	CIA0402X7R333K250GT	X7R	33nF	±10%	25V	0.55
33	CIA0402X7R473K100GT	X7R	47nF	±10%	10V	0.55
34	CIA0402X7R473K160GT	X7R	47nF	±10%	16V	0.55
35	CIA0402X7R473K250GT	X7R	47nF	±10%	25V	0.55
36	CIA0402X7R683K160GT	X7R	68nF	±10%	16V	0.55
37	CIA0402X7R823K160GT	X7R	82nF	±10%	16V	0.55
38	CIA0402X7R104K100GT	X7R	100nF	±10%	10V	0.55
39	CIA0402X7R104K160GT	X7R	100nF	±10%	16V	0.55
40	CIA0402X7R104K250GT	X7R	100nF	±10%	25V	0.55
41	CIA0402X7R104K500GT	X7R	100nF	±10%	50V	0.55
42	CIA0402X7R224K6R3GT	X7R	220nF	±10%	6.3V	0.55
43	CIA0402X7R224K100GT	X7R	220nF	±10%	10V	0.55
44	CIA0402X7R224K160GT	X7R	220nF	±10%	16V	0.55
45	CIA0402X7R224K250GT	X7R	220nF	±10%	25V	0.55
46	CIA0402X7R105K6R3GT	X7R	1uF	±10%	6.3V	0.55

尺寸: 0603(公制: 1.6mmx0.8mm)

序号	HRE料号	材质	容值	容差	耐压	最大厚度 (mm)
1	CIA0603X7R101K500JT	X7R	100pF	±10%	50V	0.90
2	CIA0603X7R681K500JT	X7R	680pF	±10%	50V	0.90
3	CIA0603X7R102K500JT	X7R	1.0nF	±10%	50V	0.90
4	CIA0603X7R102K101JT	X7R	1nF	±10%	100V	0.90
5	CIA0603X7R152K500JT	X7R	1.5nF	±10%	50V	0.90
6	CIA0603X7R222K500JT	X7R	2.2nF	±10%	50V	0.90
7	CIA0603X7R332K500JT	X7R	3.3nF	±10%	50V	0.90
8	CIA0603X7R472K500JT	X7R	4.7nF	±10%	50V	0.90
9	CIA0603X7R682K500JT	X7R	6.8nF	±10%	50V	0.90
10	CIA0603X7R103K500JT	X7R	10nF	±10%	50V	0.90
11	CIA0603X7R105K250JT	X7R	10nF	±10%	100V	0.90

### X7R系列料号表

尺寸: 0603(公制: 1.6mmx0.8mm)

序号	HRE料号	材质	容值	容差	耐压	最大厚度 (mm)
12	CIA0603X7R223K500JT	X7R	22nF	±10%	50V	0.90
13	CIA0603X7R273K500JT	X7R	27nF	±10%	50V	0.90
14	CIA0603X7R393K250JT	X7R	39nF	±10%	25V	0.90
15	CIA0603X7R473K250JT	X7R	47nF	±10%	25V	0.90
16	CIA0603X7R473K500JT	X7R	47nF	±10%	50V	0.90
17	CIA0603X7R104K160JT	X7R	100nF	±10%	16V	0.90
18	CIA0603X7R104K250JT	X7R	100nF	±10%	25V	0.90
19	CIA0603X7R104K500JT	X7R	100nF	±10%	50V	0.90
20	CIA0603X7R104K101JT	X7R	100nF	±10%	100V	0.90
21	CIA0603X7R154K160JT	X7R	150nF	±10%	16V	0.90
22	CIA0603X7R224K100JT	X7R	220nF	±10%	10V	0.90
23	CIA0603X7R224K160JT	X7R	220nF	±10%	16V	0.90
24	CIA0603X7R224K500JT	X7R	220nF	±10%	50V	0.90
25	CIA0603X7R474K160JT	X7R	470nF	±10%	16V	0.90
26	CIA0603X7R105K100JT	X7R	1.0uF	±10%	10V	0.90
27	CIA0603X7R105K160JT	X7R	1.0uF	±10%	16V	0.90
28	CIA0603X7R105K250JT	X7R	1.0uF	±10%	25V	0.90

尺寸: 0805(公制: 2.0mmx1.25mm)

序号	HRE料号	材质	容值	容差	耐压	最大厚度 (mm)
1	CIA0805X7R102K500KT	X7R	1nF	±10%	50V	0.75
2	CIA0805X7R103K500KT	X7R	10nF	±10%	50V	0.75
3	CIA0805X7R103K101KT	X7R	10nF	±10%	100V	0.75
4	CIA0805X7R153K500KT	X7R	15nF	±10%	50V	0.75
5	CIA0805X7R223K500KT	X7R	22nF	±10%	50V	0.75
6	CIA0805X7R104K250KT	X7R	100nF	±10%	25V	0.95
7	CIA0805X7R225K100MT	X7R	2.2uF	±10%	10V	1.35
8	CIA0805X7R225K160MT	X7R	2.2uF	±10%	16V	1.35
9	CIA0805X7R225K250MT	X7R	2.2uF	±10%	25V	1.35
10	CIA0805X7R225K500MT	X7R	2.2uF	±10%	50V	1.45
11	CIA0805X7R475K160MT	X7R	4.7uF	±10%	16V	1.35
12	CIA0805X7R106K6R3MT	X7R	10uF	±10%	6.3V	1.40
13	CIA0805X7R106K100MT	X7R	10uF	±10%	10V	1.40

### X7R系列料号表

尺寸: 1206(公制: 3.2mmx1.6mm)

序号	HRE料号	材质	容值	容差	耐压	最大厚度 (mm)
1	CIA1206X7R103K631MT	X7R	10nF	±10%	630V	1.40
2	CIA1206X7R104K500KT	X7R	100nF	±10%	50V	1.00
3	CIA1206X7R334K500MT	X7R	330nF	±10%	50V	1.40
4	CIA1206X7R474K500NT	X7R	470nF	±10%	50V	1.80
5	CIA1206X7R105K160MT	X7R	1uF	±10%	16V	1.40
6	CIA1206X7R105K250NT	X7R	1uF	±10%	25V	1.80
7	CIA1206X7R105K500NT	X7R	1uF	±10%	50V	1.80
8	CIA1206X7R225K160NT	X7R	2.2uF	±10%	16V	1.80
9	CIA1206X7R225K250NT	X7R	2.2uF	±10%	25V	1.80
10	CIA1206X7R225K500NT	X7R	2.2uF	±10%	50V	1.80
11	CIA1206X7R225K101NT	X7R	2.2uF	±10%	100V	1.80
12	CIA1206X7R226K6R3NT	X7R	22uF	±10%	6.3V	1.80
13	CIA1206X7R226K100NT	X7R	22uF	±10%	10V	1.80

尺寸: 1210(公制: 3.2mmx2.5mm)

序号	HRE料号	材质	容值	容差	耐压	最大厚度 (mm)
1	CIA1210X7R223K102QT	X7R	22nF	±10%	1000V	2.20
2	CIA1210X7R473K631QT	X7R	47nF	±10%	630V	2.20
3	CIA1210X7R475K500RT	X7R	4.7uF	±10%	50V	2.70
4	CIA1210X7R475K101QT	X7R	4.7uF	±10%	100V	2.20
5	CIA1210X7R106K250QT	X7R	10uF	±10%	25V	2.00
6	CIA1210X7R106K500RT	X7R	10uF	±10%	50V	2.80

### X5R系列料号表

尺寸: 0201(公制: 0.6mmx0.3mm)

序号	HRE料号	材质	容值	容差	耐压	最大厚度 (mm)
1	CIA0201X5R222K100ET	X5R	2.2nF	±10%	10V	0.33
2	CIA0201X5R472K100ET	X5R	4.7nF	±10%	10V	0.33
4	CIA0201X5R103K6R3ET	X5R	10nF	±20%	6.3V	0.33
5	CIA0201X5R103K100ET	X5R	10nF	±10%	10V	0.33
6	CIA0201X5R104K6R3ET	X5R	100nF	±10%	6.3V	0.33
7	CIA0201X5R104K100ET	X5R	100nF	±10%	10V	0.33
8	CIA0201X5R474M6R3ET	X5R	470nF	±10%	6.3V	0.33

尺寸: 0402(公制: 1.0mmx0.5mm)

序号	HRE料号	材质	容值	容差	耐压	最大厚度 (mm)
1	CIA0402X5R104K100GT	X5R	100nF	±20%	10V	0.55
2	CIA0402X5R104K160GT	X5R	100nF	±20%	16V	0.55
3	CIA0402X5R104K250GT	X5R	100nF	±10%	25V	0.55
4	CIA0402X5R224K6R3GT	X5R	220nF	±10%	6.3V	0.55
5	CIA0402X5R224K100GT	X5R	220nF	±20%	10V	0.55
6	CIA0402X5R224K160GT	X5R	220nF	±20%	16V	0.55
7	CIA0402X5R474K6R3GT	X5R	470nF	±20%	6.3V	0.55
8	CIA0402X5R474K250GT	X5R	470nF	±10%	25V	0.55
9	CIA0402X5R105M6R3GT	X5R	1.0uF	±10%	6.3V	0.55
10	CIA0402X5R105K100GT	X5R	1.0uF	±10%	10V	0.55
11	CIA0402X5R105K160GT	X5R	1.0uF	±10%	16V	0.55
12	CIA0402X5R105K250GT	X5R	1.0uF	±10%	25V	0.60
13	CIA0402X5R225M4R0GT	X5R	2.2uF	±10%	4V	0.55
14	CIA0402X5R225M6R3GT	X5R	2.2uF	±10%	6.3V	0.55
15	CIA0402X5R475M4R0GT	X5R	4.7uF	±10%	4V	0.65
16	CIA0402X5R475M6R3GT	X5R	4.7uF	±10%	6.3V	0.65

尺寸: 0603(公制: 1.6mmx0.8mm)

序号	HRE料号	材质	容值	容差	耐压	最大厚度 (mm)
1	CIA0603X5R224K250JT	X5R	220nF	±20%	25V	0.90
2	CIA0603X5R474K100JT	X5R	470nF	±20%	10V	0.90
3	CIA0603X5R474K250JT	X5R	470nF	±20%	25V	0.90
4	CIA0603X5R105K100JT	X5R	1.0uF	±10%	10V	0.90

### X5R系列料号表

尺寸: 0603(公制: 1.6mmx0.8mm)

序号	HRE料号	材质	容值	容差	耐压	最大厚度 (mm)
5	CIA0603X5R105K160JT	X5R	1.0uF	±10%	16V	0.90
6	CIA0603X5R105K250JT	X5R	1.0uF	±10%	25V	0.90
7	CIA0603X5R225K6R3JT	X5R	2.2uF	±10%	6.3V	0.90
8	CIA0603X5R225K100JT	X5R	2.2uF	±10%	10V	0.90
9	CIA0603X5R225K160JT	X5R	2.2uF	±10%	16V	0.90
10	CIA0603X5R475K6R3JT	X5R	4.7uF	±10%	6.3V	0.90
11	CIA0603X5R475K100JT	X5R	4.7uF	±10%	10V	0.90
12	CIA0603X5R106M4R0JT	X5R	10uF	±20%	4V	0.90
13	CIA0603X5R106M6R3JT	X5R	10uF	±20%	6.3V	0.90
14	CIA0603X5R226M4R0JT	X5R	22uF	±20%	4V	0.95
15	CIA0603X5R476M4R0JT	X5R	47uF	±20%	4V	1.00

尺寸: 0805(公制: 2.0mmx1.25mm)

序号	HRE料号	材质	容值	容差	耐压	最大厚度 (mm)
1	CIA0805X5R225K100MT	X5R	2.2uF	±10%	10V	1.35
2	CIA0805X5R225K250MT	X5R	2.2uF	±10%	25V	1.35
3	CIA0805X5R475M6R3MT	X5R	4.7uF	±20%	6.3V	1.35
4	CIA0805X5R475K100MT	X5R	4.7uF	±10%	10V	1.35
5	CIA0805X5R475K250MT	X5R	4.7uF	±10%	25V	1.45
6	CIA0805X5R106K6R3MT	X5R	10uF	±10%	6.3V	1.35
7	CIA0805X5R106M100MT	X5R	10uF	±20%	10V	1.45
8	CIA0805X5R106K160MT	X5R	10uF	±10%	16V	1.40
9	CIA0805X5R226M6R3MT	X5R	22uF	±20%	6.3V	1.45
10	CIA0805X5R226M100MT	X5R	22uF	±20%	10V	1.45
11	CIA0805X5R226M160MT	X5R	22uF	±20%	16V	1.45
12	CIA0805X5R226M250MT	X5R	22uF	±20%	25V	1.45
13	CIA0805X5R476M4R0MT	X5R	47uF	±20%	4V	1.45
14	CIA0805X5R476M6R3MT	X5R	47uF	±20%	6.3V	1.45

## X5R系列料号表

尺寸: 1206(公制: 3.2mmx1.6mm)

序号	HRE料号	材质	容值	容差	耐压	最大厚度 (mm)
1	CIA1206X5R475K250NT	X5R	4.7uF	±10%	25V	1.80
2	CIA1206X5R106K250NT	X5R	10uF	±10%	25V	1.80
3	CIA1206X5R226K6R3NT	X5R	22uF	±10%	6.3V	1.80
4	CIA1206X5R226M100NT	X5R	22uF	±20%	10V	1.80
5	CIA1206X5R226K160NT	X5R	22uF	±10%	16V	1.80
6	CIA1206X5R226K250NT	X5R	22uF	±10%	25V	1.80
7	CIA1206X5R476M6R3NT	X5R	47uF	±20%	6.3V	1.80
8	CIA1206X5R476M100NT	X5R	47uF	±20%	10V	1.80
9	CIA1206X5R107M6R3NT	X5R	100uF	±20%	6.3V	1.90

尺寸: 1210(公制: 3.2mmx2.5mm)

序号	HRE料号	材质	容值	容差	耐压	最大厚度 (mm)
1	CIA1210X5R226M6R3RT	X5R	22uF	±20%	6.3V	2.70
2	CIA1210X5R226M100RT	X5R	22uF	±20%	10V	2.70
3	CIA1210X5R226K160RT	X5R	22uF	±10%	16V	2.70
4	CIA1210X5R226M250RT	X5R	22uF	±20%	25V	2.70
5	CIA1210X5R476M160RT	X5R	47uF	±20%	16V	2.70
6	CIA1210X5R107M6R3RT	X5R	100uF	±20%	6.3V	2.80

## X6S系列料号表

尺寸: 0201(公制: 0.6mmx0.3mm)

序号	HRE料号	材质	容值	容差	耐压	最大厚度 (mm)
1	CIA0201X6S104K6R3ET	X6S	100nF	±10%	6.3V	0.33
2	CIA0201X6S104K160ET	X6S	100nF	±10%	16V	0.33

尺寸: 0402(公制: 1.0mmx0.5mm)

序号	HRE料号	材质	容值	容差	耐压	最大厚度 (mm)
1	CIA0402X6S474K6R3GT	X6S	470nF	±10%	6.3V	0.55
2	CIA0402X6S105K6R3GT	X6S	1uF	±10%	6.3V	0.55
3	CIA0402X6S105K6R3GT	X6S	1uF	±10%	6.3V	0.6
4	CIA0402X6S105K100GT	X6S	1uF	±10%	10V	0.55
5	CIA0402X6S105K250GT	X6S	1uF	±10%	25V	0.6
6	CIA0402X6S225K100GT	X6S	2.2uF	±10%	10V	0.7

尺寸: 0603(公制: 1.6mmx0.8mm)

序号	HRE料号	材质	容值	容差	耐压	最大厚度 (mm)
1	CIA0603X6S475K4R0JT	X6S	4.7uF	±10%	4V	0.90
2	CIA0603X6S475M6R3JT	X6S	4.7uF	±20%	6.3V	0.90
3	CIA0603X6S475K1600JT	X6S	4.7uF	±10%	16V	1.00
4	CIA0603X6S106M6R3JT	X6S	10uF	±20%	6.3V	0.90
5	CIA0603X6S106M100JT	X6S	10uF	±20%	10V	1.00
6	CIA0603X6S226M4R0JT	X6S	22uF	±20%	4V	1.00
7	CIA0603X6S226M6R3JT	X6S	22uF	±20%	6.3V	1.00
8	CIA0603X6S476M2R5JT	X6S	47uF	±20%	2.5V	1.00
9	CIA0603X6S476M4R0JT	X6S	47uF	±20%	4V	1.00

尺寸: 0805(公制: 2.0mmx1.25mm)

序号	HRE料号	材质	容值	容差	耐压	最大厚度 (mm)
1	CIA0805X6S106K6R3MT	X6S	10uF	±10%	6.3V	1.4
2	CIA0805X6S106K160MT	X6S	10uF	±10%	16V	1.45
3	CIA0805X6S226M4R0MT	X6S	22uF	±20%	4V	1.45
4	CIA0805X6S226M6R3MT	X6S	22uF	±20%	6.3V	1.45

## X6S系列料号表

尺寸: 0805(公制: 2.0mmx1.25mm)

序号	HRE料号	材质	容值	容差	耐压	最大厚度 (mm)
5	CIA0805X6S226M100MT	X6S	22uF	±20%	10V	1.45
6	CIA0805X6S226M160MT	X6S	22uF	±20%	16V	1.45
7	CIA0805X6S476M4R0MT	X6S	47uF	±20%	4V	1.45

尺寸: 1206(公制: 3.2mmx1.6mm)

序号	HRE料号	材质	容值	容差	耐压	最大厚度 (mm)
1	CIA1206X6S476M6R3NT	X6S	47uF	±20%	6.3V	1.8
2	CIA1206X6S107M4R0NT	X6S	100uF	±20%	4V	1.9

尺寸: 1206(公制: 3.2mmx1.6mm)

序号	HRE料号	材质	容值	容差	耐压	最大厚度 (mm)
1	CIA1210X6S107M6R3RT	X6S	100uF	±20%	6.3V	2.7



## 工业级电容--Level II

### 特性

工业级--Level II 电容 (MLCC) 是一种使用于工业应用的贴片电容。在一般常规电容 (MLCC) 性能的基础上, 提高了产品的防潮性能和更高的可靠性。

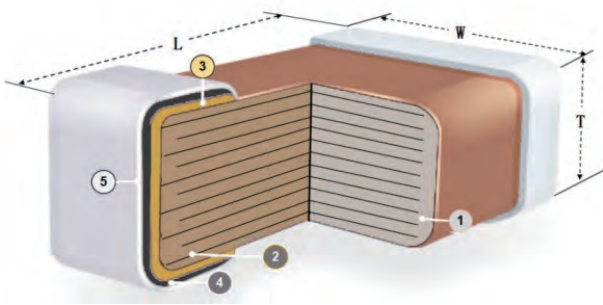

序号	名称
1	陶瓷介质
2	内电极
3	外电极
4	镍层
5	锡层

### 增强可靠度

可靠度项目	一般常规电容 (含中高压)	工业级-Level I	工业级-Level II
高温高湿	40°C 95%RH 1Vr 500h	65°C 90%RH 1Vr 500h	85°C 85%RH 1Vr 1000h
高温加载	高温 1.5Vr 1000h	高温 1.5Vr 1000h	高温 1.5Vr 1000h
抗弯曲力	1mm	1mm	2mm
冷热冲击	5个循环	5个循环	1000个循环

### 应用

基站, 太阳能逆变器, DC-DC转换器等。

### C0G系列容值范围表

产品等级	材质	尺寸 (inch)	电压 (Vdc)	pF				nF			uF		容值范围
				0.1	1	10	100	1	10	100	1	10	
工业级 Level II	C0G 125°C	0402	50		■								0.56pF

### X7R系列容值范围表

产品等级	材质	尺寸 (inch)	电压 (Vdc)	pF				nF			uF		容值范围	
				0.1	1	10	100	1	10	100	1	10		100
工业级 Level II	X7R 125°C	0603	25									■	1.0uF	
			50									■	220nF~270nF	
		0805	25										■	2.2uF
			50										■	1.0uF

### C0G系列料号表

尺寸: 0402(公制: 1.0mmx0.5mm)

序号	HRE料号	材质	容值	容差	耐压	最大厚度 (mm)
1	CIB0402C0G5R6C500GT	C0G	5.6pF	±0.25pF	50	0.55

### X7R系列料号表

尺寸: 0603(公制: 1.6mmx0.8mm) & 尺寸: 0805(公制: 2.0mmx1.25mm)

序号	HRE料号	材质	容值	容差	耐压	最大厚度 (mm)
1	CIB0603X7R224K500JT	X7R	220nF	±10%	50V	0.90
2	CIB0603X7R334K500JT	X7R	330nF	±10%	50V	0.90
3	CIB0603X7R474K500JT	X7R	470nF	±10%	50V	0.90
4	CIB0603X7R105K250JT	X7R	1.0uF	±10%	25V	0.90
5	CIB0805X7R105K500MT	X7R	1.0uF	±10%	50V	1.35
6	CIB0805X7R225K250MT	X7R	2.2uF	±10%	25V	1.35

### 可靠性规格和测试条件

序号	项目	技术规格	测试条件																																																														
1	外观	电容陶瓷本体和端电极无明显伤痕	在10倍显微镜下目测																																																														
2	尺寸	产品符合对应的结构和尺寸要求	使用精度不低于 0.01 mm 的量具 测量(千分尺)																																																														
3	电容量 (C)	符合标称电容量及其允许偏差范围 (二类材质 (X7R、X5R、X6S) 电容量测前, 需对样品进行 150°C±10 °C,1小时热处理, 再常温静置 24小时)																																																															
		C0G Cap < 30pF, DF ≤ 1/(400+20*C)(C:pF); Cap ≥ 30pF, DF ≤ 10*10 <sup>-4</sup>																																																															
4	损耗 DF/Tanδ	<table border="1"> <thead> <tr> <th>尺寸</th> <th>电压</th> <th>容值范围</th> <th>DF</th> </tr> </thead> <tbody> <tr> <td rowspan="2">0201</td> <td>≤25V</td> <td>Cap ≤ 0.22uF</td> <td>≤10%</td> </tr> <tr> <td>&gt; 25V</td> <td>Cap ≤ 0.01uF</td> <td>≤7%</td> </tr> <tr> <td rowspan="4">0402</td> <td rowspan="2">≤25V</td> <td>Cap ≤ 0.47uF</td> <td>≤7%</td> </tr> <tr> <td>Cap &gt; 0.47uF</td> <td>≤10%</td> </tr> <tr> <td rowspan="2">&gt; 25V</td> <td>Cap ≤ 0.1uF</td> <td>≤7%</td> </tr> <tr> <td>Cap &gt; 0.1uF</td> <td>≤10%</td> </tr> <tr> <td rowspan="4">0603</td> <td rowspan="2">≤25V</td> <td>Cap ≤ 0.47uF</td> <td>≤7%</td> </tr> <tr> <td>Cap &gt; 0.47uF</td> <td>≤10%</td> </tr> <tr> <td rowspan="2">&gt; 25V</td> <td>Cap ≤ 0.1uF</td> <td>≤5%</td> </tr> <tr> <td>0.1uF &lt; Cap ≤ 0.22uF</td> <td>≤7%</td> </tr> <tr> <td rowspan="4">0805</td> <td rowspan="2">≤25V</td> <td>Cap ≤ 1uF</td> <td>≤7%</td> </tr> <tr> <td>Cap &gt; 1uF</td> <td>≤10%</td> </tr> <tr> <td rowspan="2">&gt; 25V</td> <td>Cap ≤ 0.47uF</td> <td>≤7%</td> </tr> <tr> <td>Cap &gt; 0.47uF</td> <td>≤10%</td> </tr> <tr> <td rowspan="4">1206</td> <td rowspan="2">≤25V</td> <td>Cap &lt; 2.2uF</td> <td>≤7%</td> </tr> <tr> <td>2.2uF ≤ Cap ≤ 47uF</td> <td>≤10%</td> </tr> <tr> <td rowspan="2">&gt; 25V</td> <td>Cap &lt; 1uF</td> <td>≤7%</td> </tr> <tr> <td>1uF ≤ Cap &lt; 47uF</td> <td>≤10%</td> </tr> <tr> <td rowspan="2">1210</td> <td>≤25V</td> <td>Cap &lt; 2.2uF</td> <td>≤7%</td> </tr> <tr> <td>&gt; 25V</td> <td>2.2uF ≤ Cap ≤ 47uF</td> <td>≤10%</td> </tr> </tbody> </table>	尺寸	电压	容值范围	DF	0201	≤25V	Cap ≤ 0.22uF	≤10%	> 25V	Cap ≤ 0.01uF	≤7%	0402	≤25V	Cap ≤ 0.47uF	≤7%	Cap > 0.47uF	≤10%	> 25V	Cap ≤ 0.1uF	≤7%	Cap > 0.1uF	≤10%	0603	≤25V	Cap ≤ 0.47uF	≤7%	Cap > 0.47uF	≤10%	> 25V	Cap ≤ 0.1uF	≤5%	0.1uF < Cap ≤ 0.22uF	≤7%	0805	≤25V	Cap ≤ 1uF	≤7%	Cap > 1uF	≤10%	> 25V	Cap ≤ 0.47uF	≤7%	Cap > 0.47uF	≤10%	1206	≤25V	Cap < 2.2uF	≤7%	2.2uF ≤ Cap ≤ 47uF	≤10%	> 25V	Cap < 1uF	≤7%	1uF ≤ Cap < 47uF	≤10%	1210	≤25V	Cap < 2.2uF	≤7%	> 25V	2.2uF ≤ Cap ≤ 47uF	≤10%	测试温度: 25°C±3°C 测试湿度: < 70%RH  C0G: C ≤ 1000pF, 测试频率: 1MHz±10% 测试电压: 1.0Vrms±0.2Vrms C > 1000pF, 测试频率: 1KHz±10% 测试电压: 1.0Vrms±0.2Vrms  X7R/X5R/X6S C ≤ 10μF 测试频率: 1KHz±10% 测试电压: 1.0Vrms±0.2Vrms C > 10μF 测试频率: 120Hz±24Hz 测试电压: 0.5Vrms±0.1Vrms
尺寸	电压	容值范围	DF																																																														
0201	≤25V	Cap ≤ 0.22uF	≤10%																																																														
	> 25V	Cap ≤ 0.01uF	≤7%																																																														
0402	≤25V	Cap ≤ 0.47uF	≤7%																																																														
		Cap > 0.47uF	≤10%																																																														
	> 25V	Cap ≤ 0.1uF	≤7%																																																														
		Cap > 0.1uF	≤10%																																																														
0603	≤25V	Cap ≤ 0.47uF	≤7%																																																														
		Cap > 0.47uF	≤10%																																																														
	> 25V	Cap ≤ 0.1uF	≤5%																																																														
		0.1uF < Cap ≤ 0.22uF	≤7%																																																														
0805	≤25V	Cap ≤ 1uF	≤7%																																																														
		Cap > 1uF	≤10%																																																														
	> 25V	Cap ≤ 0.47uF	≤7%																																																														
		Cap > 0.47uF	≤10%																																																														
1206	≤25V	Cap < 2.2uF	≤7%																																																														
		2.2uF ≤ Cap ≤ 47uF	≤10%																																																														
	> 25V	Cap < 1uF	≤7%																																																														
		1uF ≤ Cap < 47uF	≤10%																																																														
1210	≤25V	Cap < 2.2uF	≤7%																																																														
	> 25V	2.2uF ≤ Cap ≤ 47uF	≤10%																																																														
5	绝缘阻抗 I.R.	UR ≤ 50V, Ri ≥ 10GΩ 或 Ri*C ≥ 100Ω-F (大于等于其中较小的数值) UR > 50V, Ri ≥ 4GΩ 或 Ri*C ≥ 100Ω-F (大于等于其中较小的数值)	测试温度: 25°C±3°C U <sub>测</sub> = U <sub>R</sub> 直流电压 充电时间: 60±5 秒																																																														

### 可靠性规格和测试条件

序号	项目	技术规格	测试条件																												
6	耐电压	不应有电介质被击穿或损伤	$U_R \leq 50V$ COG: $3 \cdot U_R$ , 5 秒, 最大电流不超过 50mA X5R/X7R: $2.5 \cdot U_R$ , 5 秒, 最大电流不超过 50mA. $50V < U_R < 200V$ $2.5 \cdot U_R$ , 5 秒, 最大电流不超过 50mA. $200V \leq U_R \leq 1000V$ $1.5 \cdot U_R$ , 5 秒, 最大电流不超过 50mA. $U_R > 1000V$ $1.2 \cdot U_R$ , 5 秒, 最大电流不超过 50mA.																												
7	温度特性	COG 容量变化在 $\pm 30ppm/^\circ C$ 以内 X7R/X5R 容量变化在 $\pm 15\%$ 以内 X6S 容量变化在 $\pm 22\%$ 以内	X5R/X7R/X6S先 $150^\circ C$ 预处理 1 小时, 放置 24h后进行测量。在 $t_1$ 、 $25^\circ C$ 、 $t_2$ 下测量电容量, 符合相应的容量变化特性 NP0/X7R: $t_1 - 55^\circ C$ , $t_2 125^\circ C$ X5R: $t_1 - 55^\circ C$ , $t_2 85^\circ C$ X6S: $t_1 - 55^\circ C$ , $t_2 105^\circ C$																												
8	附着力	外观无可见损伤	施加5N的平行推力, 并保持 $10 \pm 1$ 秒。 *2N for 0201(公制: 0603) *1N for 01005(公制: 0402 )																												
9	端电极的结合强度	当按如下所示板子弯曲1mm时: 外观: 无可见损伤; 容量变化: NP0 (COG): $\Delta C/C \leq \pm 5\%$ 或 $\pm 0.5pF$ (取较大值); X7R/X5R/X6S: $\Delta C/C \leq \pm 12.5\%$ ;	<table border="1"> <thead> <tr> <th>Size EIA</th> <th>a(mm)</th> <th>b(mm)</th> <th>c(mm)</th> </tr> </thead> <tbody> <tr> <td>0201</td> <td>0.3</td> <td>0.9</td> <td>0.3</td> </tr> <tr> <td>0402</td> <td>0.4</td> <td>1.5</td> <td>0.5</td> </tr> <tr> <td>0603</td> <td>1.0</td> <td>3.0</td> <td>1.2</td> </tr> <tr> <td>0805</td> <td>1.2</td> <td>4.0</td> <td>1.65</td> </tr> <tr> <td>1206</td> <td>2.2</td> <td>5.0</td> <td>2.0</td> </tr> <tr> <td>1808</td> <td>3.5</td> <td>7.0</td> <td>2.5</td> </tr> </tbody> </table>	Size EIA	a(mm)	b(mm)	c(mm)	0201	0.3	0.9	0.3	0402	0.4	1.5	0.5	0603	1.0	3.0	1.2	0805	1.2	4.0	1.65	1206	2.2	5.0	2.0	1808	3.5	7.0	2.5
Size EIA	a(mm)	b(mm)	c(mm)																												
0201	0.3	0.9	0.3																												
0402	0.4	1.5	0.5																												
0603	1.0	3.0	1.2																												
0805	1.2	4.0	1.65																												
1206	2.2	5.0	2.0																												
1808	3.5	7.0	2.5																												
10	端头可焊性	上锡良好, 端头润湿率大于 90%	将测试电容浸入含松香的乙醇溶液3-5秒, 在 $80 \sim 140^\circ C$ 预热 30 ~ 60秒, 浸入 $235 \pm 5^\circ C$ 的熔融锡液 $3.0 \pm 0.3$ 秒, 浸入10mm。																												

### 可靠性规格和测试条件

序号	项目	技术规格	测试条件
11	耐焊接热	外观无明显损伤异常 NP0(C0G): 容量变化在 $\pm 2.5\%$ 或 $\pm 0.25\text{pF}$ (取较大值) X7R/X5R: 容量变化在 $\pm 15\%$ 以内; X6S:容量变化在 $\pm 22\%$ 以内; DF&IR符合初值的要求	II类材质 $150^{\circ}\text{C}$ 、1小时预热处理后放置 $24\pm 1$ 小时初始值测量。 然后 $110\sim 140^{\circ}\text{C}$ 预热 30~60秒, 浸入 $260\pm 5^{\circ}\text{C}$ 的锡槽中 $10\pm 1$ 秒, 浸入深度 10mm; 然后在室温放置 $24\pm 2$ 小时NP0(C0G)或 $48\pm 4$ 小时 (X7R、X5R、X6S) 后进行外观检查与电性测试。
12	温度快速变化	外观无明显损伤异常 NP0(C0G): 容量变化在 $\pm 2.5\%$ 或 $\pm 0.25\text{pF}$ (取较大值) X7R/X5R: 容量变化在 $\pm 15\%$ 以内; X6S:容量变化在 $\pm 22\%$ 以内; DF&IR符合初值的要求	按下列步骤进行 5 次循环: 步骤 温度( $^{\circ}\text{C}$ ) 时间 1 $t_1$ 30 min. 2 25 2~5min. 3 $t_2$ 30 min. 4 25 2~5 min. NP0: $t_1-55^{\circ}\text{C}, t_2 125^{\circ}\text{C}$ X5R: $t_1-55^{\circ}\text{C}, t_2 85^{\circ}\text{C}$ X6S: $t_1-55^{\circ}\text{C}, t_2 105^{\circ}\text{C}$ X7R: $t_1-55^{\circ}\text{C}, t_2 125^{\circ}\text{C}$ 然后在室温放置 $24\pm 2$ 小时NP0 (C0G) 或 $48\pm 4$ 小时 (X7R、X5R、X6S) 后进行外观检查与电性测试。 II类材质 $150^{\circ}\text{C}$ 、1小时预热处理后放置 $24\pm 1$ 小时初始值测量。
13	稳态湿热	外观无明显可见损伤 NP0(C0G): 容量变化在 $\pm 5\%$ 或 $\pm 0.5\text{pF}$ (取较大值) 以内 $C < 10\text{pF}, Q \geq 200 + 10^{\circ}\text{C}$ ; $10 \leq C < 30\text{pF}, Q \geq 275 + 2.5^{\circ}\text{C}$ $C \geq 30\text{pF}, Q \geq 350$ IR: $> 1\text{G}\Omega$ 或 $R_i \cdot C \geq 10\Omega \cdot \text{F}$ (取较小值) X5R/X7R/X6S: 容量变化在 $\pm 12.5\%$ 以内 DF 为初始值的 2 倍以下 IR:大于 $1000\text{M}\Omega$ 或 $10\Omega \cdot \text{F}$ (取较小值)	测试温度: $40\pm 2^{\circ}\text{C}$ 湿度: 90~95% RH 测试时间: $500 \pm 12\text{hrs}$ 在室温下放置 $24\pm 2$ (NP0) 或 $48\pm 4$ (X7R、X5R、X6S) 小时以后测量。 II类材质 $150^{\circ}\text{C}$ 、1小时预热处理后放置 $24\pm 1$ 小时初始值测量。

### 可靠性规格和测试条件

序号	项目	技术规格	测试条件
14	耐湿负荷	外观无明显可见损伤 NPO(C0G): 容量变化在 $\pm 7.5\%$ 或 $\pm 0.75\text{pF}$ (取较大值) 以内 $C < 30\text{pF}$ , $Q \geq 100 + 10/3 \cdot C_p$ ; $C \geq 30\text{pF}$ , $Q \geq 350$ IR: $> 500\text{M}\Omega$ 或 $R_i \cdot C \geq 5\Omega \cdot F$ (取较小值) X5R/X7R/X6S 容量变化在 $\pm 12.5\%$ 以内 DF 为初始值的 2 倍以下 IR:大于 $500\text{M}\Omega$ 或 $5\Omega \cdot F$ (取较小值)	测试温度: $40 \pm 2^\circ\text{C}$ 湿度: 90~95% RH 电压: 额定电压 测试时间: $500 \pm 12\text{hrs}$ 在室温下放置 $24 \pm 2$ (NPO) 或 $48 \pm 4$ (X7R/X5R/X6S)小时以后 测量 * II 类材质在 $40 \pm 2^\circ\text{C}$ 温 度下, 将电容加额定直流电压 1hrs.去掉电压, 将电容器在室 温下放置 $48 \pm 4\text{hrs}$ 测量初始电 容值。
15	寿命试验	外观无明显可见损伤 NPO(C0G): 容量变化在 $\pm 3\%$ 或 $\pm 0.3\text{pF}$ (取较大值) 以内 $C < 10\text{pF}$ , $Q \geq 200 + 10 \cdot C$ ; $10 \leq C_p < 30\text{pF}$ , $Q \geq 275 + 2.5 \cdot C$ $C \geq 30\text{pF}$ , $Q \geq 350$ IR: $> 1\text{G}\Omega$ 或 $R_i \cdot C \geq 5\Omega \cdot F$ (取较小值) X5R/X7R/X6S: 容量变化在 $\pm 12.5\%$ 以内 DF 为初始值的 2 倍以下 IR:大于 $1000\text{M}\Omega$ 或 $5\Omega \cdot F$ (取较小值)	测试温度: NPO/X7R: $125^\circ\text{C}$ ; X5R: $85^\circ\text{C}$ X6S: $105^\circ\text{C}$ 温度 $\pm 3^\circ\text{C}$ 电压: $U_r < 100\text{V}$ 1.5 倍额定电压 测试时间: 1000 小时 在室温下放置 $24 \pm 2$ (NPO) 或 $48 \pm 4$ (X7R/X5R/X6S) 小时后测量 * II 类材质电容器的初始值测量 在限类别温度 $\pm 3^\circ\text{C}$ , 将电容器 加1.5倍额定直流电压 1 小时去 掉电压, 将电容器在室温下放置 $48 \pm 4\text{hrs}$ 测量初始电容值

## 产品包装

载带卷盘包装是目前最常见的包装方式，一个直径为180mm（7"）的卷轴可包含1000~20000个电容,也可按照客户的要求进行卷盘包装。

### 包装数量

规格	尺寸 Size (mm)			编带规格	
	长度 L	宽度 W	厚度 T	包装数量 (pcs)	包材 (默认卷盘7inch)
01005	0.40	0.20	0.20	20,000	纸带
0201	0.60	0.30	0.30	15,000	纸带
0402	1.00	0.50	0.50	10,000	纸带
0603	1.60	0.80	0.80	4,000	纸带
			0.60	4,000	纸带
0805	2.00	1.25	0.85	4,000	纸带
			1.25	2,000/3,000	塑胶带
			0.85	4,000	纸带
1206	3.20	1.60	1.25	2,000/3,000	塑胶带
			1.60	2,000	塑胶带
			1.25	2,000	塑胶带
1210	3.20	2.50	1.60	2,000	塑胶带
			2.00	1,000	塑胶带
			2.50	1,000	塑胶带

### 纸带尺寸

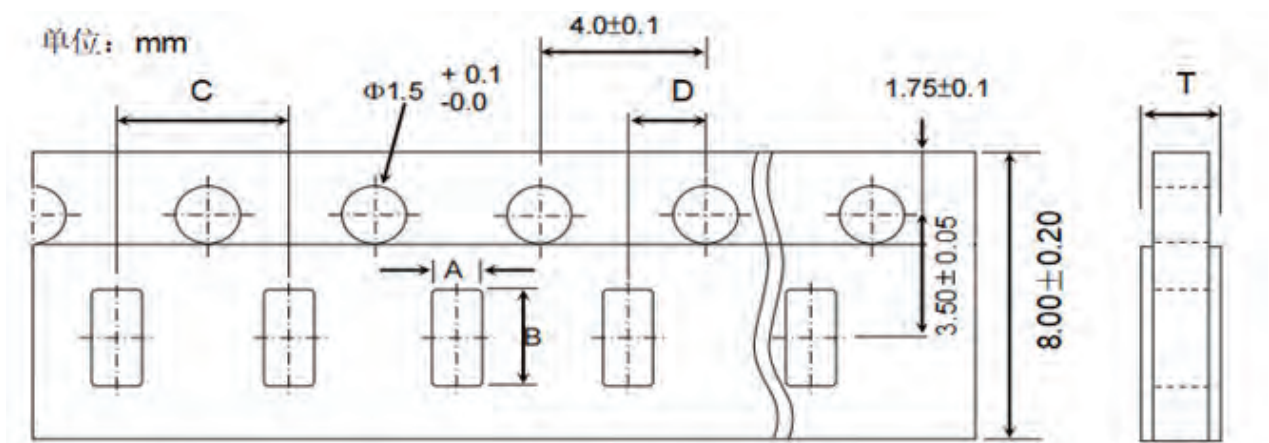

## 纸带尺寸

Type (inch)	A (mm)	B (mm)	C (mm)	D (mm)	T (mm)
01005	0.24±0.03	0.45±0.03	2.0±0.10	2.0±0.05	0.42max
0201	0.36±0.03	0.67±0.03	2.0±0.10	2.0±0.05	0.42max
0402	0.65±0.10	1.15±0.10	2.0±0.05	2.0±0.05	0.8max
0603	1.05±0.10	1.85±0.10	4.0±0.10	2.0±0.10	1.1max
0805	1.55±0.15	2.3±0.15	4.0±0.10	2.0±0.10	1.1max
1206	1.95±0.15	3.5±0.15	4.0±0.10	2.0±0.10	1.1max

## 塑料带尺寸

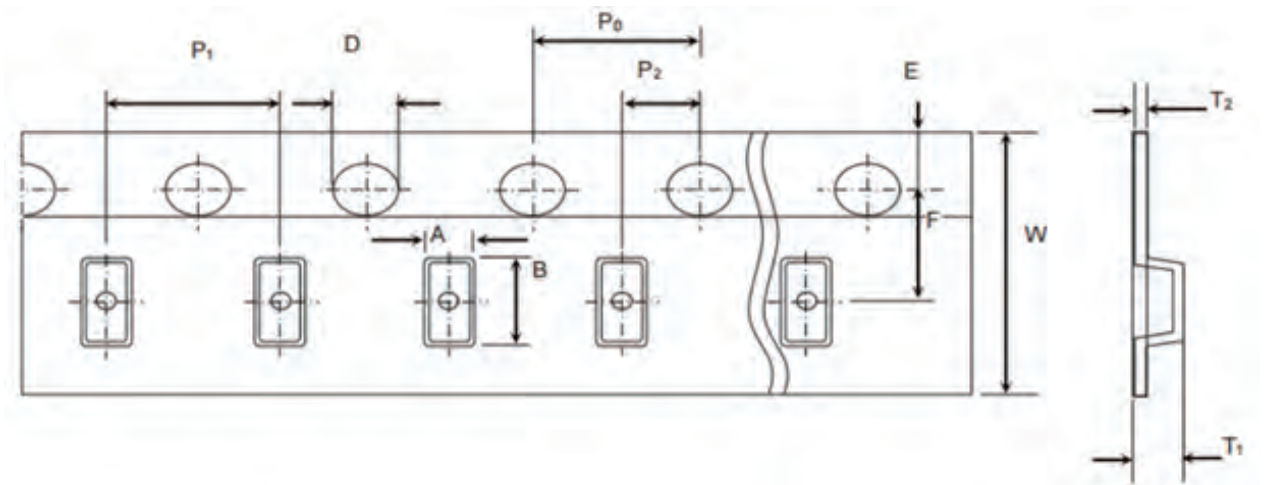

	1608 (0603)	2012 (0805)	3216 (1206)	3225 (1210)
P1	4±0.1	4±0.1	4±0.1	4±0.1
P0	4±0.1	4±0.1	4±0.1	4±0.1
P2	2±0.05	2±0.05	2±0.05	2±0.05
A	1.2±0.2	1.45±0.2	1.9±0.2	2.8±0.2
B	2.0±0.2	2.3±0.2	3.5±0.2	3.6±0.2
W	8±0.3	8±0.2	8±0.2	8±0.2
E	1.75±0.1	1.75±0.1	1.75±0.1	1.75±0.1
F	3.5±0.05	3.5±0.05	3.5±0.05	3.5±0.05
D	1.5 (+0.1/-0.0)	1.5 (+0.1/-0.0)	1.5 (+0.1/-0.0)	1.5 (+0.1/-0.0)
T1	1.4 max.	2.5 max.	2.5 max.	2.5 max.
T2	0.25±0.1	0.305±0.1	0.30±0.1	0.30±0.1



## 圆盘尺寸

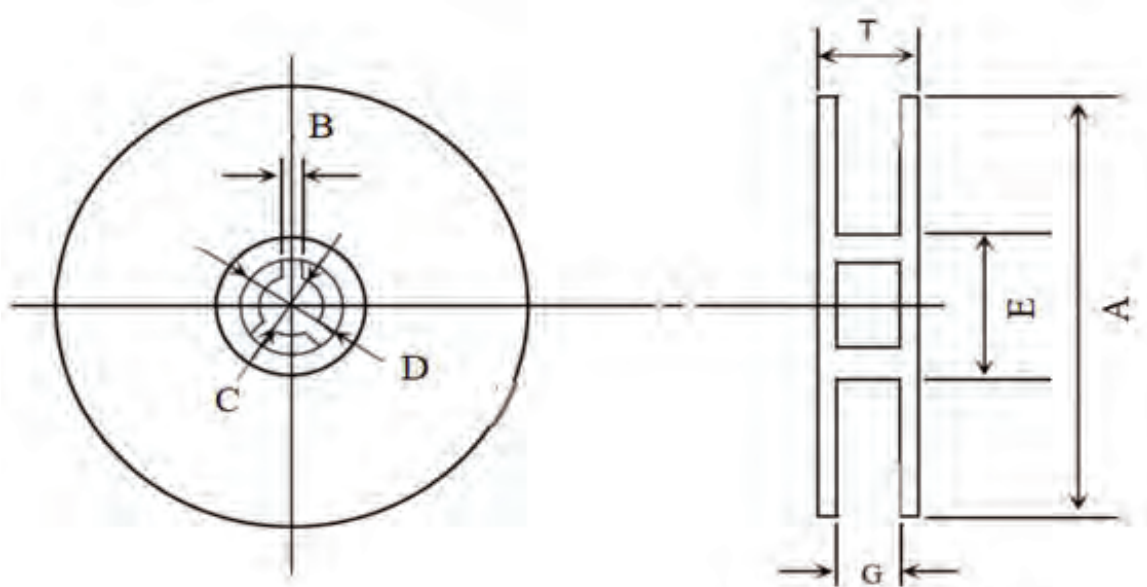

圆盘尺寸	A (mm)	B (mm)	C (mm)	D (mm)	E (mm)	G (mm)	T (mm)
7" Reel	$\Phi 178 \pm 2.0$	$2.0 \pm 0.5$	$\Phi 13 \pm 1.0$	$\Phi 21 \pm 0.8$	$\Phi 50$ 或更大	$10 \pm 1.0$	$13 \pm 1.0$

## 包装方式和规格

一般情况下使用 $\Phi 180\text{mm}$  (7") 的料盘进行包装，每5盘封装为一盒，每12盒为一整箱。不足整盒的单独用一小盒包装。也可以按照客户的要求进行包装。

Size EIA	载带	料盘尺寸	盘/盒	盒/箱
01005	纸带	7"	5	12
0201	纸带	7"	5	12
0402	纸带	7"	5	12
0603	纸带	7"	5	12
0805	纸带/塑料带	7"	5	12
1206	纸带/塑料带	7"	5	12
1210	塑料带	7"	5	12

## 卷装带使用说明

成品在使用时，上带（膜）以  $300 \pm 10\text{mm/min}$  的速度， $165^\circ \sim 180^\circ$  的角度(如下图所示)，剥离强度在  $0.1\text{N} \sim 0.7\text{N}$  ( $10\text{g.f} \leq \text{剥离力} \leq 70\text{g.f}$ )。

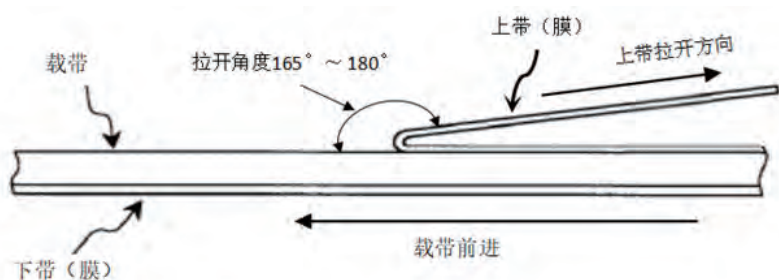

## 运输与储存方法

运输：包装的产品适应现代交通工具运输，在运输过程中要防止雨淋和酸碱腐蚀，不得重力抛掷和猛力挤压。

储存：确保产品可焊性良好的贮存期限为：自生产之日保存期为一年，产品使用之前请勿拆开编带(在包装好已交付的情况下)，编带拆开后，产品应在三个月内使用。

储存温度：5°C~40°C

储存相对湿度：< 70%

### 使用注意事项

多层片式瓷介电容器（MLCC）在超出本承诺书或相关说明书中所述使用频率的恶劣工作环境,或外界机械力超压作用下,电容有可能会短路、开路，或者有可能会冒烟、燃烧甚至爆炸,所以在使用的時候,首先应考虑按本承诺书的有关说明来进行,如有不明之处,请联系我们技术部、品管部或生产部。

焊接时焊料的用量：



A.焊料过多这样会因电容端头压力过大而引起电容受损；



B.焊料太少固定力量不足,可能会引起电容芯片与线路接触不良

推荐焊料用量：

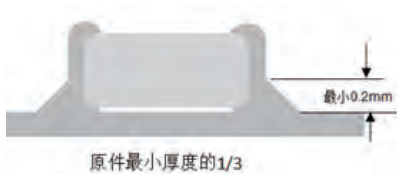

A.回流焊接的最佳焊料用量

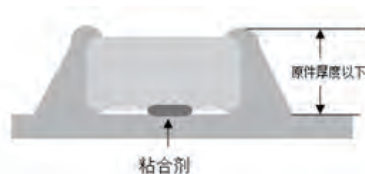

B.波峰焊接的最佳焊料用量



C.使用烙铁返修时的最佳焊料量

### 使用注意事项

#### 推荐焊接温度曲线图:

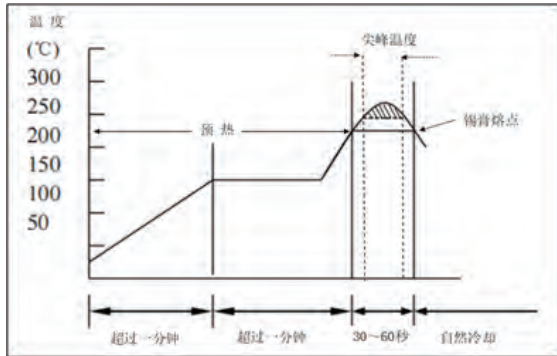

回流焊接

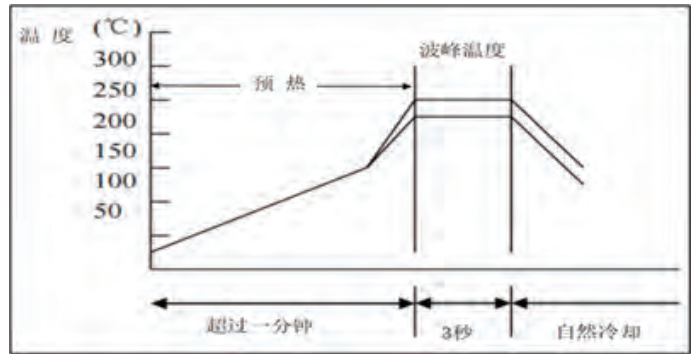

波峰焊接

焊锡类型	Pb-Sn焊接	无铅焊接
尖峰温度	230°C~250°C	240°C~260°C
尖峰温度	3s~10s	3s~10s

焊锡类型	Pb-Sn焊接	无铅焊接
尖峰温度	230°C~260°C	240°C~270°C
尖峰温度	3s内	3s内

#### 手工焊接

手工焊接很容易因为电容局部受热不均而引起瓷体微裂或局部爆裂现象。因此,使用电烙铁手工焊接时应仔细操作,并对电烙铁的尖端的选择和尖端温度控制应多加小心。

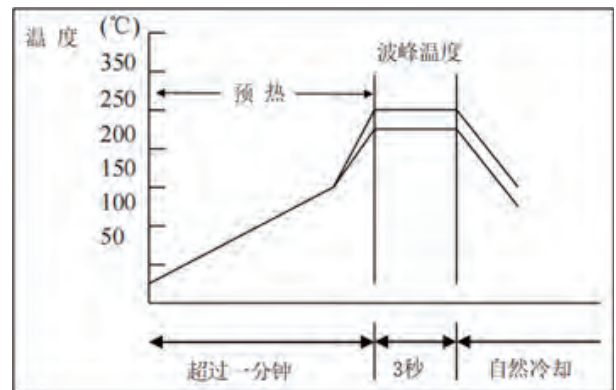

预热	烙铁头温度	烙铁功率	烙铁头直径	焊接时间	锡膏量	注意事项
$\Delta \leq 130^\circ\text{C}$	$\leq 350^\circ\text{C}$	$\leq 20\text{W}$	建议1mm	$\leq 3\text{s}$	$\leq 1/2$ 电容高度	烙铁头勿直接接触陶瓷本体

## X-ON Electronics

Largest Supplier of Electrical and Electronic Components

*Click to view similar products for [Multilayer Ceramic Capacitors MLCC - SMD/SMT](#) category:*

*Click to view products by [HRE](#) manufacturer:*

Other Similar products are found below :

[M39014/02-1225V](#) [M39014/22-0631](#) [D55342E07B523DR-T/R](#) [NCA1206X7R103K50TRPF](#) [NCA1206X7R104K16TRPF](#) [NIN-FC2R7JTRF](#)  
[NMC0402NPO220J50TRPF](#) [NMC0402X5R105K6.3TRPF](#) [NMC0402X5R224K6.3TRPF](#) [NMC0402X7R103J25TRPF](#)  
[NMC0402X7R392K50TRPF](#) [NMC0603NPO201J50TRPF](#) [NMC0603X7R333K16TRPF](#) [NMC0805NPO820J50TRPF](#)  
[NMC0805X7R224K16TRPLPF](#) [NMC1206X7R102K50TRPF](#) [NMC1206X7R106K10TRPLPF](#) [NMC1206X7R475K10TRPLPF](#) [NMC-](#)  
[Q0402NPO8R2D200TRPF](#) [C1608C0G2A221J](#) [C1608X7R1E334K](#) [C2012C0G2A472J](#) [2220J2K00562KXT](#) [CDR33BX104AKUR](#)  
[CDR33BX683AKUS](#) [CGA3E1X7R1C684K](#) [CL10C0R8BB8ANNC](#) [C1005X5R0G225M](#) [C2012X7R2E223K](#) [C3216C0G2J272J](#)  
[D55342E07B35E7R-T/R](#) [NMC0402X7R562J25TRPF](#) [NMC0603NPO102J25TRPF](#) [NMC1206X7R332K50TRPF](#) [726632-1](#)  
[CGA6M3X7R1H225K](#) [CGA5L2X7R2A105K](#) [CGA3E2X8R1H223K](#) [CDR33BX823AKUR\M500](#) [CDR35BX474AKUR\M500](#)  
[CDR35BX104BKUR\M500](#) [69995D](#) [NMC0201X5R473K6.3TRPF](#) [NMC0201X7R221K25TRPF](#) [NMC0402X5R105K10TRPF](#)  
[NMC0402X5R224K10TRPF](#) [NMC0603X7R104J25TRPF](#) [NMC0603X7R223K25TRPF](#) [NMC0805NPO100J50TRPF](#)  
[NMC0805X7R104M50TRPF](#)