

FPC0.5B-WTX-nP
 PIN数
 卧式、贴片
 PIN间距

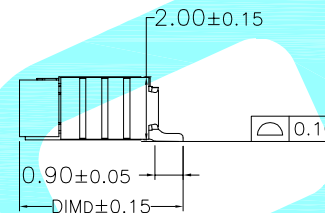
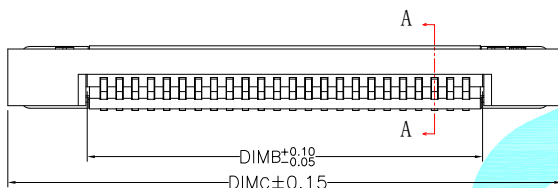
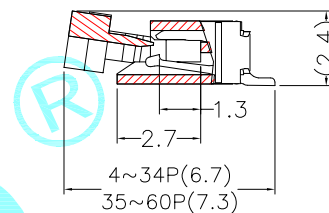
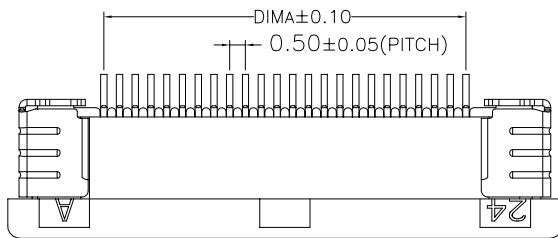

SECTION A-A

- 1.Pin pitch: 0.5
- 2.Rated voltage: 50V AC/DC
- 3.Contact resistance: $\leq 30m\Omega$
- 4.Insulation resistance: $\geq 500M\Omega$
- 5.Operating temperature: $-25^{\circ}C \sim +85^{\circ}C$

CKT	DIM A	DIM B	DIM C	DIM D	CKT	DIM A	DIM B	DIM C	DIM D
4	1.50	2.56	7.60	5.20	33	16.00	17.06	22.10	5.75
5	2.00	3.06	8.10		34	16.50	17.56	22.60	
6	2.50	3.56	8.60		35	17.00	18.06	23.10	
7	3.00	4.06	9.10		36	17.50	18.56	23.60	
8	3.50	4.56	9.60		37	18.00	19.06	24.10	
9	4.00	5.06	10.10		38	18.50	19.56	24.60	
10	4.50	5.56	10.60		39	19.00	20.06	25.10	
11	5.00	6.06	11.10		40	19.50	20.56	25.60	
12	5.50	6.56	11.60		41	20.00	21.06	26.10	
13	6.00	7.06	12.10		42	20.50	21.56	26.60	
14	6.50	7.56	12.60		43	21.00	22.06	27.10	
15	7.00	8.06	13.10		44	21.50	22.56	27.60	
16	7.50	8.56	13.60		45	22.00	23.06	28.10	
17	8.00	9.06	14.10		46	22.50	23.56	28.60	
18	8.50	9.56	14.60		47	23.00	24.06	29.10	
19	9.00	10.06	15.10		48	23.50	24.56	29.60	
20	9.50	10.56	15.60		49	24.00	25.06	30.10	
21	10.00	11.06	16.10		50	24.50	25.56	30.60	
22	10.50	11.56	16.60		51	25.00	26.06	31.10	
23	11.00	12.06	17.10		52	25.50	26.56	31.60	
24	11.50	12.56	17.60		53	26.00	27.06	32.10	
25	12.00	13.06	18.10		54	26.50	27.56	32.60	
26	12.50	13.56	18.60		55	27.00	28.06	33.10	
27	13.00	14.06	19.10		56	27.50	28.56	33.60	
28	13.50	14.56	19.60		57	28.00	29.06	34.10	
29	14.00	15.06	20.10		58	28.50	29.56	34.60	
30	14.50	15.56	20.60		59	29.00	30.06	35.10	
31	15.00	16.06	21.10		60	29.50	30.56	35.60	
32	15.50	16.56	21.60						

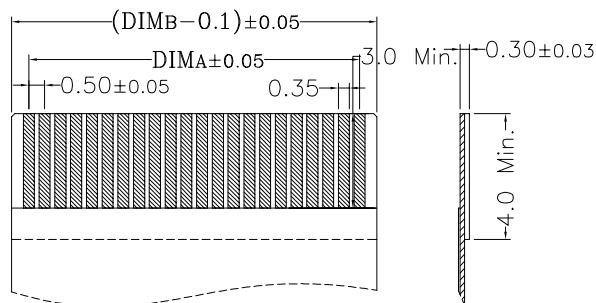
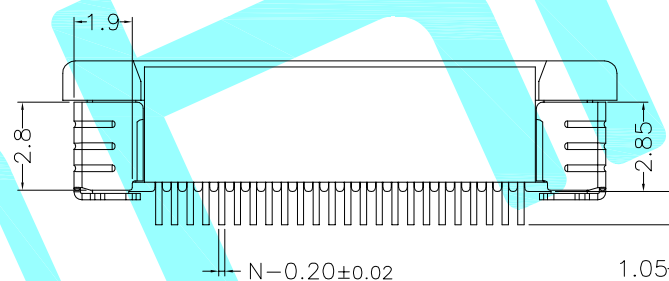

适用扁平线 (Applicable Flat Cable)

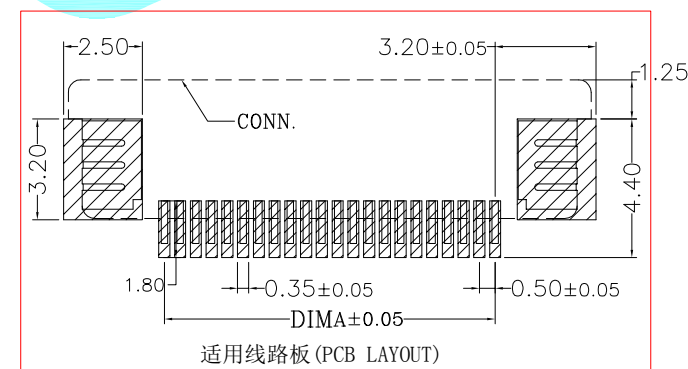

适用线路板 (PCB LAYOUT)

④	Soldering lug	—	1	Copper Alloy	Sn Plated	—
③	Cover	—	1	LCP UL94V0	Black	—
②	PIN	—	—	Copper Alloy	Sn Plated	—
①	Housing	—	1	LCP UL94V0	Natural	—
ITEM	PART NAME	TER'NO.	QTY.	MATERIAL	FINISHING	REMARK

APPROVALS		DATE						
DRAWN	LIUCAN	2021.11.9					TITLE:	Bar Connector Series
CHECKED				PART NO.	FPC0.5B-WTX-nP			
APPROVALS				TOLERANCES ARE	ANGLE	UNIT: mm	SCALE: 1:1	PROJ:
		30~以上	±0.30	±2'	DRAWING NO.	SHEET 1 OF 1		
		10~30	±0.20					
		5~10	±0.15					
		~ 5	±0.10					

ECN NO.	REV.	DATE.	DESCRIPTION.	CHANGE.	CHECK.	APPRO.
	A		NEW			

X-ON Electronics

Largest Supplier of Electrical and Electronic Components

Click to view similar products for [FFC & FPC Connectors](#) category:

Click to view products by [HRO parts](#) manufacturer:

Other Similar products are found below :

[00-6200-227-022-800](#) [006205250500825+](#) [006205280500825+](#) [FPH-1602G](#) [086222026001800](#) [52610-0675](#) [62674-201121DLF](#) [52746-1671-TR250](#) [10051922-1610EHLF](#) [10051922-2810EHLF](#) [686322124422](#) [XF3M-2915-1B-R100](#) [AYF353125A](#) [AYF530665TA](#) [AYF534065TA](#) [20FLH-RSM1-TB](#) [PCA-7F-25-HL-3-G](#) [207356-1](#) [52807-0430](#) [FFC05011-10SBB114W5M](#) [502250-8027](#) [FH28K-40S-0.5SH](#) [200528-0260](#) [FH28K-10S-0.5SH](#) [501951-1250](#) [X05B20U43T](#) [0.5K-DX-30PWB](#) [DS1020-08-10VBT12](#) [THD0515-34CL-GF](#) [X05A10L28G](#) [ECC2841061EU](#) [20539-030E-01](#) [1.0K-DHQX-16PWB](#) [1.0K-DHQX-30PWB](#) [1775333-6](#) [10054365-202110ELF](#) [10054365-242110ELF](#) [10054365-282110ELF](#) [10064555-392220HLF](#) [59453-041110EBHLF](#) [59453-091110EDHLF](#) [62674-241141ALF](#) [62684-432100ALF](#) [62684-451100AHLF](#) [62684-5721N0ALF](#) [HFW11R-1STE1MTLF](#) [HFW12R-1STE9LF](#) [HFW14R-1STE9MTLF](#) [HFW18S-2STE9LF](#) [HFW20R-1STAE1HLF](#)