

INGRESS PROTECTION:IP67

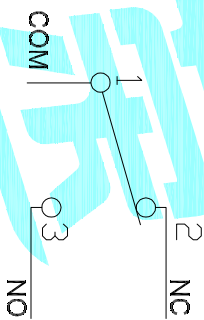

Circuit Diagram

- NOTE:
1. Rating:DC12V 3A
 2. Operating force:130gf MAX
 3. Mechanical Life:500,000

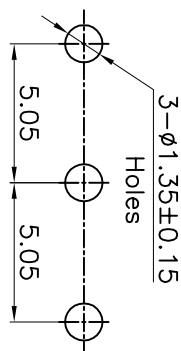
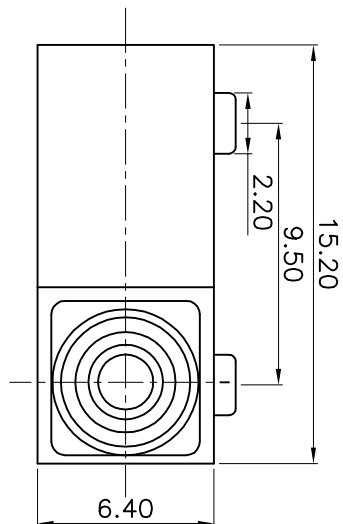
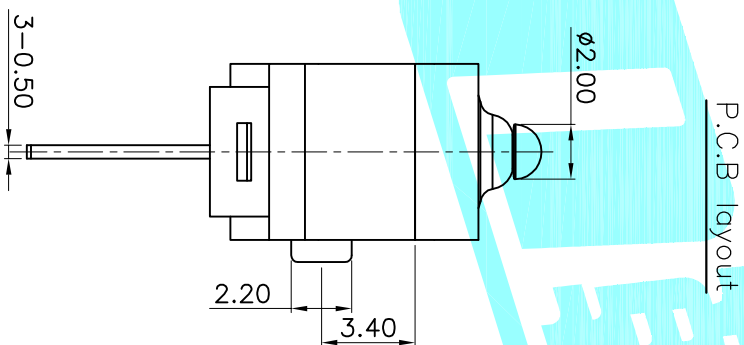
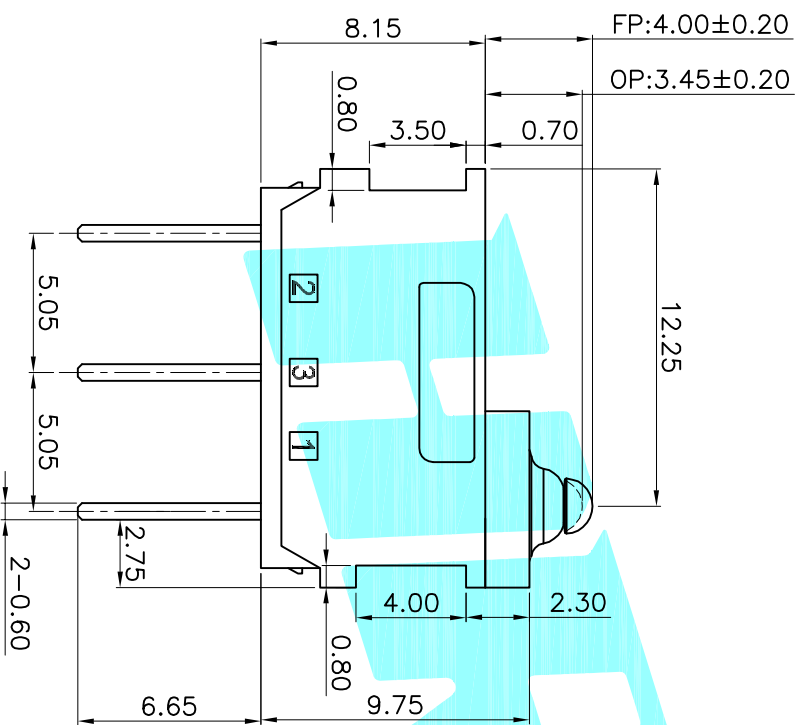

| ITEM | PART NAME | TER'NO. | QTY. | MATERIAL | FINISHING | REMARK |
|------|---------------|---------|------|-----------------|----------------|--------|
| ⑦ | Shrapnel | — | 1 | Brass | — | — |
| ⑥ | Contact | — | 1 | Ag | — | — |
| ⑤ | Sealed Circle | — | 1 | Silicone Rubber | — | — |
| ④ | Terminal | — | 3 | Brass(0.50t) | Plating silver | — |
| ③ | Plunger | — | 1 | POM | White | — |
| ② | Cose | — | 1 | PA | White | — |
| ① | Cover | — | 1 | PA | Black | — |



| APPROVALS | DATE | TITLE |
|-----------|-----------|----------|
| DRAWN | J.X.Zhang | 2018/8/1 |
| CHECKED | | |
| APPROVALS | | |

| | |
|---------------------|----------|
| ELECTRONICS CO.,LTD | |
| MICRO SWITCHS | |
| PART NO. | K9-1802B |

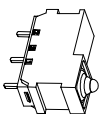
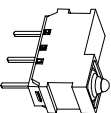
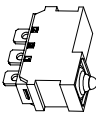
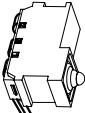
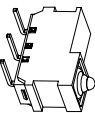
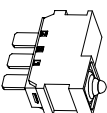
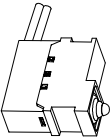
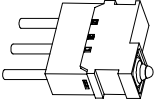
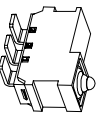
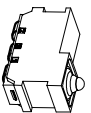
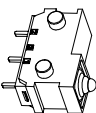
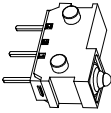
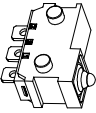
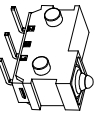
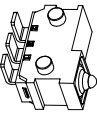
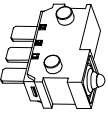
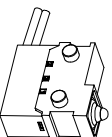
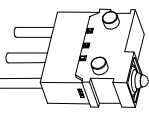
| ECN NO. | REV. | DATE. | DESCRIPTION. | CHANGE. | CHECK. | APPRO. | TOLERANCES ARE | 30 [±] mm | 10 [±] mm | 5 [±] mm | ±0.30 | ±0.20 | ±0.15 | ±0.10 | ANGLE | ±2° | UNIT: | mm | SCALE: | 1:1 | PROD. | SHEET |
|---------|------|-------|--------------|---------|--------|--------|--------------------|--------------------|--------------------|-------------------|-------|-------|-------|-------|-------|-----|-------|-----|--------|-------|--------|-------|
| | A | | NEW | | | | 10 [±] mm | 30 [±] mm | 5 [±] mm | ±0.15 | ±0.20 | ±0.15 | ±0.10 | ±2° | | | mm | 1:1 | | PROD. | 1 OF 1 | |

| | | | | | | |
|---|---|---|---|---|---|---|
|  |  |  |  |  |  |  |
| A | B | C | D | E | F | G |
|  |  |  |  |  |  |  |
| H | I | J | K | L | M | N |
|  |  |  |  | | | |
| O | P | Q | R | | | |

NO. : 1

| | | | | | | |
|----------------|-----------|---------------------|--------------|--|---|--------|
| APPROVALS | | DATE | |  ELECTRONICS CO.,LTD | | |
| DRAWN | J.X.Zhang | 2018/8/1 | | | | |
| CHECKED | | TITLE: | | MICRO SWITCHS | | |
| APPROVALS | | PART NO. | | K9-1802□ | | |
| TOLERANCES ARE | | 30 ^{±0.15} | ±0.30 | ANGLE | SCALE: 1:1 | |
| | | 10 ^{±0.10} | ±0.20 | | PROJ.  | |
| | | 5 ^{±0.05} | ±0.15 | | SHEET 1 OF 1 | |
| ECN NO. | REV. | DATE. | DESCRIPTION. | CHANGE. | CHECK. | APPRO. |
| | A | | NEW | | | |

X-ON Electronics

Largest Supplier of Electrical and Electronic Components

Click to view similar products for [Basic / Snap Action Switches](#) category:

Click to view products by [HRO parts manufacturer](#):

Other Similar products are found below :

[83228001](#) [01.098.1358.1](#) [602EN1-6B](#) [602EN532](#) [602EN535-RB](#) [602HE5-RB1](#) [604HE162](#) [604HE223-6B](#) [624HE17-RB](#) [6HM89](#) [6PA78-JM](#)
[6SE1](#) [6SX1-H58](#) [70500840](#) [MBD5B1](#) [MBH2731](#) [73-316-0012](#) [79211759](#) [79211923](#) [79218589](#) [7AS12](#) [ML-1155](#) [ML-1376](#) [831010C3.0](#)
[831060C3.TL](#) [831090C2.EL](#) [83131904](#) [84212012](#) [8AS239](#) [8HM73-3](#) [903VB1-PG](#) [914CE1-6G](#) [PL-100](#) [11SM1077-H4](#) [11SM1077-H58](#)
[11SM1-TN107](#) [11SM405](#) [11SM703-T](#) [11SM8423-H2](#) [11SX37-T](#) [11SX48-H58](#) [11SX55-H58](#) [11SM2442-T](#) [11SM76-T](#) [11SM77-H58](#)
[11SM77-T](#) [11SM863-T](#) [11SM866](#) [11SX47-H58](#) [A7CN-1M-1-LEFT](#)