

INGRESS PROTECTION:IP67

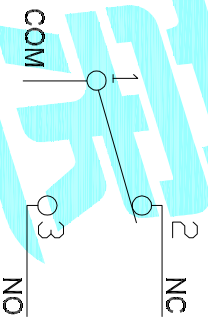

Circuit Diagram

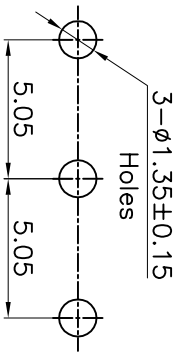
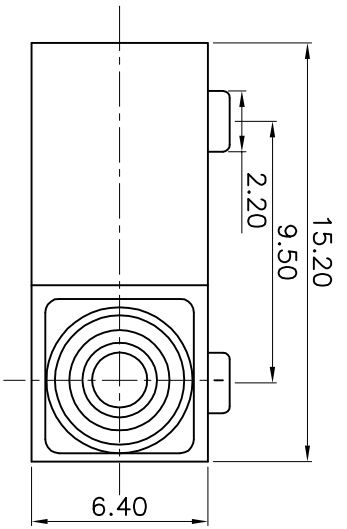
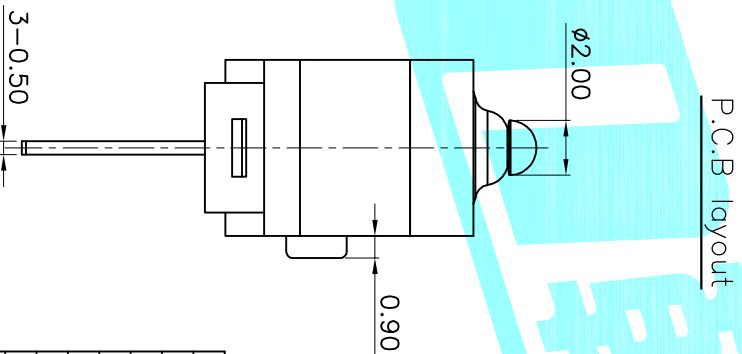
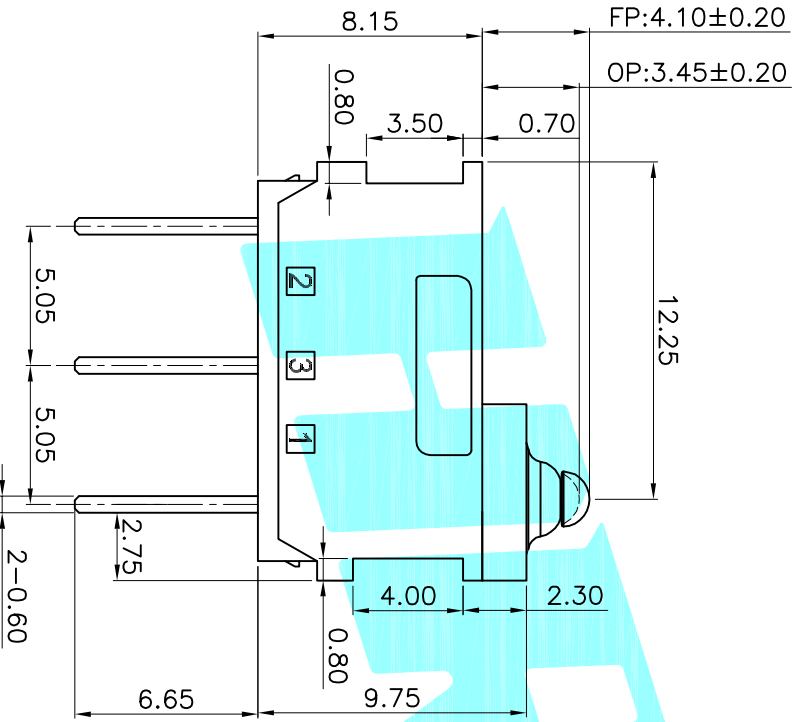

- NOTE:
1. Rating1: DC12V 3A
 2. Rating2: 48VDC/125VAC/250VAC 0.1A
 3. Operating force:75±30gf&130±30gf
 4. Electric Life:10,000
 5. Mechanical Life:1,000,000

⑦	Shrapnel	1	Brass	Plating silver	
⑥	Contact	1	Ag		
⑤	Sealed Circle	1	Silicone Rubber		
④	Terminal	3	Brass(0.50t)	Plating silver	
③	Plunger	1	POM	Black	
②	Cose	1	PA	Black	
①	Cover	1	PA	Black	

APPROVALS	DATE	TITLE
DRAWN J.X.Zhang	2018/8/1	MICRO SWITCHS
CHECKED		
APPROVALS		

APPROVALS	DATE	TITLE
DRAWN J.X.Zhang	2018/8/1	MICRO SWITCHS
CHECKED		
APPROVALS		

APPROVALS	DATE	TITLE
DRAWN J.X.Zhang	2018/8/1	MICRO SWITCHS
CHECKED		
APPROVALS		

APPROVALS	DATE	TITLE
DRAWN J.X.Zhang	2018/8/1	MICRO SWITCHS
CHECKED		
APPROVALS		

APPROVALS	DATE	TITLE
DRAWN J.X.Zhang	2018/8/1	MICRO SWITCHS
CHECKED		
APPROVALS		

ECN NO.	REV.	DATE.	DESCRIPTION.	CHANGE.	CHECK.	APPRO.
	A		NEW			

TOLERANCES ARE	30 ^{±0.15}	±0.30	ANGLE	UNIT: mm	SCALE: 1:1	PROD.
	10 ^{±0.20}	±0.20				
	5 ^{±0.15}	±0.15	±2°	DRAWING NO.		SHEET 1 OF 1



ELECTRONICS CO.,LTD

MICRO SWITCHS



K9-1802B

PROD.

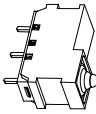
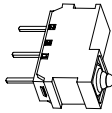
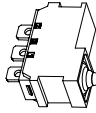
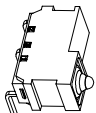
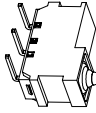
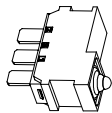
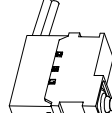
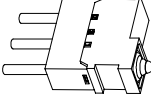
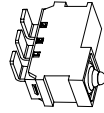
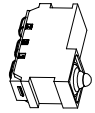
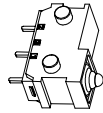
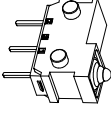
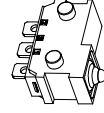
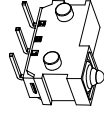
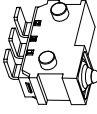
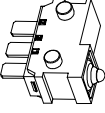
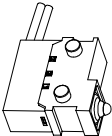
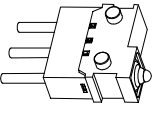
SHEET 1 OF 1

						
A	B	C	D	E	F	G
						
H	I	J	K	L	M	N
						
O	P	Q	R			

NO. : 1

APPROVALS		DATE		 ELECTRONICS CO.,LTD		
DRAWN	J.X.Zhang	2018/8/1				
CHECKED		TITLE:		MICRO SWITCHS		
APPROVALS		PART NO.		K9-1802□		
TOLERANCES ARE		30 ^{±0.15}	±0.30	ANGLE	SCALE: 1:1	
		10 ^{±0.10}	±0.20		PROJ. 	
		5 ^{±0.05}	±0.15		SHEET 1 OF 1	
ECN NO.	REV.	DATE.	DESCRIPTION.	CHANGE.	CHECK.	APPRO.
	A		NEW			

X-ON Electronics

Largest Supplier of Electrical and Electronic Components

Click to view similar products for [Basic / Snap Action Switches](#) category:

Click to view products by [HRO parts manufacturer](#):

Other Similar products are found below :

[83228001](#) [01.098.1358.1](#) [602EN1-6B](#) [602EN532](#) [602EN535-RB](#) [602HE5-RB1](#) [604HE162](#) [604HE223-6B](#) [624HE17-RB](#) [6HM89](#) [6PA78-JM](#)
[6SE1](#) [6SX1-H58](#) [70500840](#) [MBD5B1](#) [MBH2731](#) [73-316-0012](#) [79211759](#) [79211923](#) [79218589](#) [7AS12](#) [ML-1155](#) [ML-1376](#) [831010C3.0](#)
[831060C3.TL](#) [831090C2.EL](#) [83131904](#) [84212012](#) [8AS239](#) [8HM73-3](#) [903VB1-PG](#) [914CE1-6G](#) [PL-100](#) [11SM1077-H4](#) [11SM1077-H58](#)
[11SM1-TN107](#) [11SM405](#) [11SM703-T](#) [11SM8423-H2](#) [11SX37-T](#) [11SX48-H58](#) [11SX55-H58](#) [11SM2442-T](#) [11SM76-T](#) [11SM77-H58](#)
[11SM77-T](#) [11SM863-T](#) [11SM866](#) [11SX47-H58](#) [A7CN-1M-1-LEFT](#)