

定制款，尾接端子壳

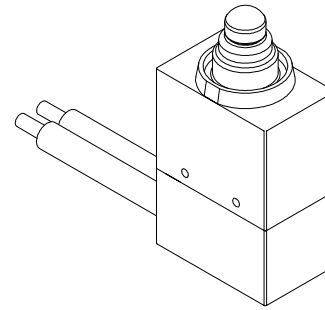

NOTE:

- 1.Rating:DC12V 0.1A
- 2.Operating froce:150gf MAX
- 3.Life:10,000

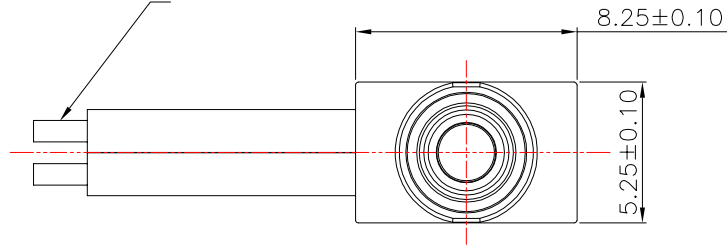

COM/NC:UL1571 28AWG

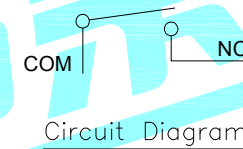
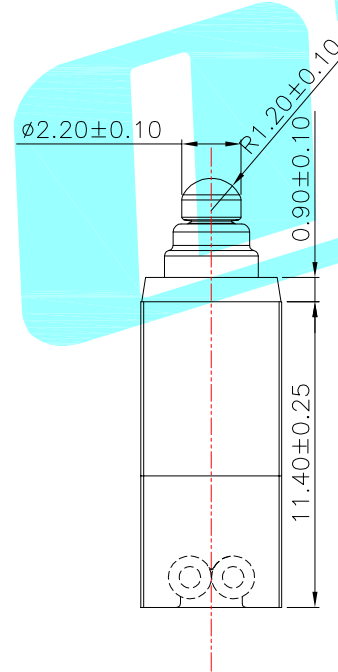
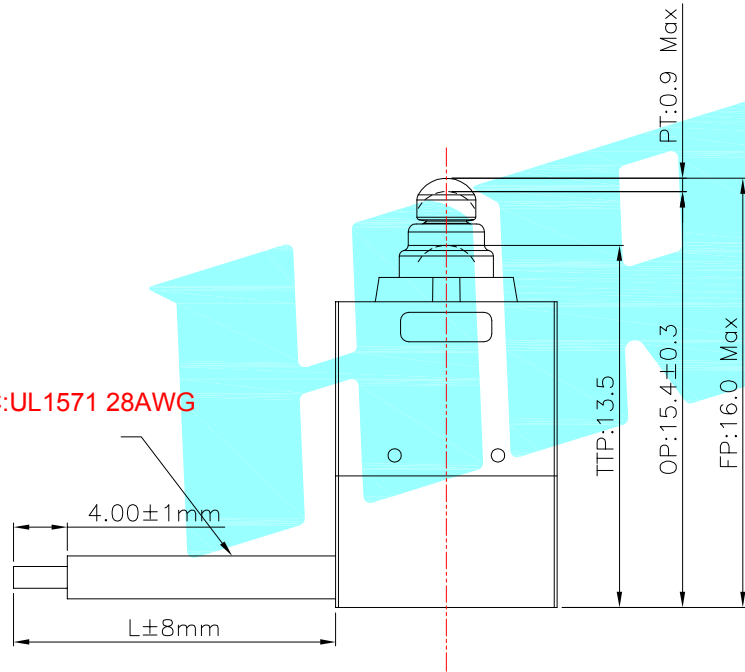

| Part No. | Wire color | L | Terminal |
|----------------|--------------|-----|----------|
| K9-1804ND-Y14E | Blue/Black | 200 | 1.5mm 2P |
| K9-1804ND-Y14F | Green/Black | 275 | 1.5mm 2P |
| K9-1804ND-Y14G | Yellow/Black | 380 | 1.5mm 3P |

| ⑥ | Shrapnel | — | 1 | Brass | Plating silver | — |
|------|---------------|---------|------|-----------------|----------------|--------|
| ⑤ | Sealed Circle | — | 1 | Silicone Rubber | — | — |
| ④ | Terminal | — | 2 | Brass(0.50t) | Plating silver | — |
| ③ | Plunger | — | 1 | POM | Black | — |
| ② | Case | — | 1 | PA | Black | — |
| ① | Cover | — | 1 | PA | Black | — |
| ITEM | PART NAME | TER'NO. | QTY. | MATERIAL | FINISHING | REMARK |

| APPROVALS | | DATE | | HRO 韓榮® ELECTRONICS CO.,LTD | | |
|----------------|--------|-------------------------------|----------------------------------|--------------------------------|---------------|-------------|
| DRAWN | LIUCAN | 2023.2.6 | | TITLE: | MICRO SWITCHS | |
| CHECKED | | | | PART NO. | | |
| APPROVALS | | | | UNIT: mm | SCALE: 1:1 | PROJ: |
| TOLERANCES ARE | | 30~以上 10~30 5~10 ~ 5 | ±0.30 ±0.20 ±0.15 ±0.10 | ANGLE | ±2' | DRAWING NO. |
| ECN NO. | REV. | DATE. | DESCRIPTION. | CHANGE. | CHECK. | APPRO. |

| | | | | | | |
|---------|------|-------|--------------|---------|--------|--------|
| _____ | A | _____ | NEW | _____ | _____ | _____ |
| ECN NO. | REV. | DATE. | DESCRIPTION. | CHANGE. | CHECK. | APPRO. |

| | | | | | |
|----------------|-------|-------|-------------|------------|--------------|
| 30~以上 | ±0.30 | ANGLE | UNIT: mm | SCALE: 1:1 | PROJ: |
| 10~30 | ±0.20 | | | | |
| 5~10 | ±0.15 | | | | |
| ~ 5 | ±0.10 | | | | |
| TOLERANCES ARE | | ±2' | DRAWING NO. | | SHEET 1 OF 1 |

K9-1804选型表

K9-1804ND-X12A

| | |
|------|--------|
| 开关系列 | 名称 |
| K9 | 防水微动开关 |

| 编码 | 图示 | 定位类型 |
|----|---|-----------|
| N |  | 无定位柱 |
| R |  | 右侧定位柱(右圆) |
| L |  | 左侧定位柱(右圆) |
| A |  | 右侧定位柱(左圆) |
| B |  | 左侧定位柱(左圆) |
| C |  | 右侧定位柱(双圆) |
| D |  | 左侧定位柱(双圆) |
| E |  | 两侧定位柱(左圆) |

| 编码 | 定位柱长度L |
|----|--------|
| D | 无定位柱 |
| 1 | 0.7MM |
| 2 | 1.0MM |
| 3 | 2.0MM |
| 4 | 5.0MM |

| 编码 | 线材长度L |
|----|-------|
| 0 | 无线材省略 |
| A | 300mm |
| B | 200mm |
| 其它 | ... |

| 流水号 | 电线规格 |
|-----|----------------|
| 0 | 无线材省略 |
| 1 | UL1007 22AWG美标 |
| 2 | UL1007 24AWG美标 |

| 编码 | 触点类型 |
|----|------------|
| 1 | 常开 SPST-NO |
| 2 | 常闭 SPST-NC |

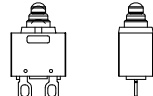
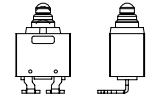
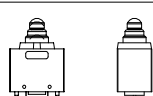
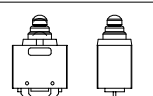
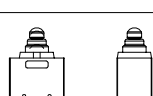
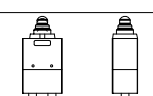
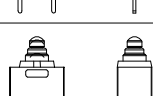
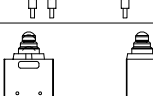
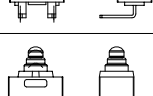
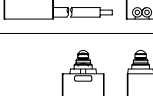
| 编码 | 端子类型 | 编码 | 端子类型 |
|----|---|----|---|
| A |  | E |  |
| B |  | F |  |
| P |  | W |  |
| R |  | X |  |
| L |  | Y |  |

X-ON Electronics

Largest Supplier of Electrical and Electronic Components

Click to view similar products for [Basic / Snap Action Switches](#) category:

Click to view products by [HRO parts manufacturer](#):

Other Similar products are found below :

[5SM901-S12](#) [5SM9-S12N195](#) [602EN532](#) [602EN535-RB](#) [602HE5-RB1](#) [604HE223-6B](#) [624HE17-RB](#) [6HM82](#) [6SE1](#) [6SX1-H58](#) [71051](#) [714-0293](#) [MBH2731](#) [79211923](#) [79218589](#) [MIL30126AB6BBMD4A12XAU](#) [ML-1155](#) [ML-1376](#) [831010C3.0](#) [831090C2.EL](#) [83131904](#) [84212012](#) [8AS239](#) [8HM73-3](#) [8SX26-H33](#) [914CE1-6G](#) [11SM1077-H4](#) [11SM1077-H58](#) [11SM1-TN107](#) [11SM405](#) [11SM703-T](#) [11SM8423-H2](#) [11SX37-T](#) [11SX48-H58](#) [11SM2442-T](#) [11SM76-T](#) [11SM77-H58](#) [11SM77-T](#) [11SM863-T](#) [11SM866](#) [121EN188-R](#) [1245.0120](#) [125EN56-RB](#) [D433V3RD](#) [1267.0101](#) [1267.7101](#) [D4BFC1](#) [12SM4-T2](#) [12SX2-T2](#) [1298.0101](#)