

定制款，尾接端子壳

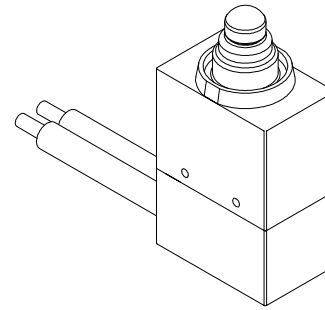

NOTE:

- 1.Rating:DC12V 0.1A
- 2.Operating froce:150gf MAX
- 3.Life:10,000

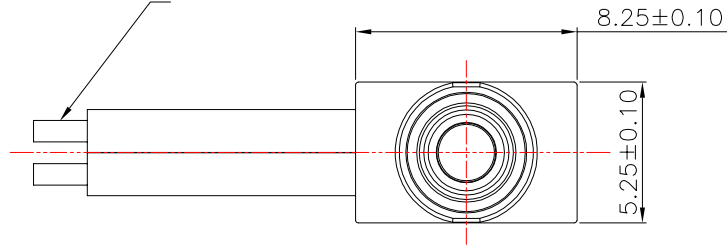

COM/NC:UL1571 28AWG

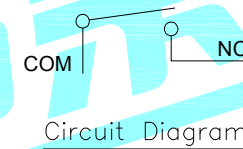
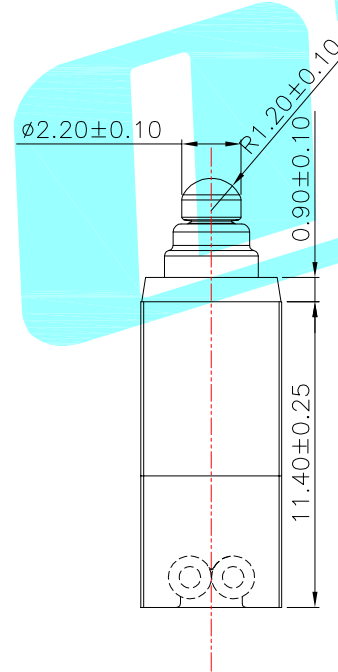
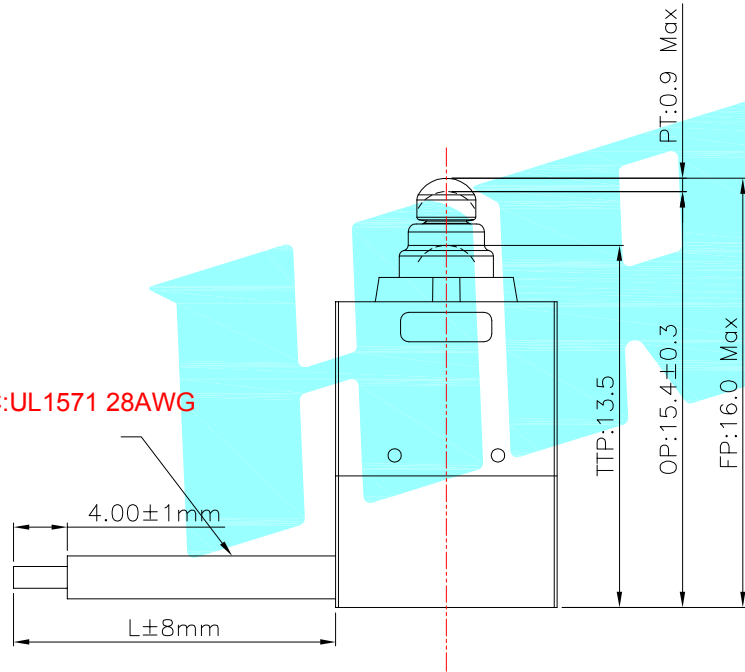

| Part No.       | Wire color   | L   | Terminal |
|----------------|--------------|-----|----------|
| K9-1804ND-Y14E | Blue/Black   | 200 | 1.5mm 2P |
| K9-1804ND-Y14F | Green/Black  | 275 | 1.5mm 2P |
| K9-1804ND-Y14G | Yellow/Black | 380 | 1.5mm 3P |

| ⑥    | Shrapnel      | —       | 1    | Brass           | Plating silver | —      |
|------|---------------|---------|------|-----------------|----------------|--------|
| ⑤    | Sealed Circle | —       | 1    | Silicone Rubber | —              | —      |
| ④    | Terminal      | —       | 2    | Brass(0.50t)    | Plating silver | —      |
| ③    | Plunger       | —       | 1    | POM             | Black          | —      |
| ②    | Case          | —       | 1    | PA              | Black          | —      |
| ①    | Cover         | —       | 1    | PA              | Black          | —      |
| ITEM | PART NAME     | TER'NO. | QTY. | MATERIAL        | FINISHING      | REMARK |

| APPROVALS      |        | DATE     |       | HRO 韓榮®<br>ELECTRONICS CO.,LTD |               |              |
|----------------|--------|----------|-------|--------------------------------|---------------|--------------|
| DRAWN          | LIUCAN | 2023.2.6 |       | TITLE:                         | MICRO SWITCHS |              |
| CHECKED        |        |          |       | PART NO.                       |               |              |
| APPROVALS      |        |          |       | UNIT: mm                       | SCALE: 1:1    | PROJ:        |
| TOLERANCES ARE |        | 30~以上    | ±0.30 | ANGLE                          | DRAWING NO.   | SHEET 1 OF 1 |
|                |        | 10~30    | ±0.20 |                                |               |              |
|                |        | 5~10     | ±0.15 |                                |               |              |
|                |        | ~ 5      | ±0.10 |                                |               |              |

| ECN NO. | REV. | DATE. | DESCRIPTION. | CHANGE. | CHECK. | APPRO. |
|---------|------|-------|--------------|---------|--------|--------|
|         | A    |       | NEW          |         |        |        |

# K9-1804选型表

## K9-1804ND-X12A

|      |        |
|------|--------|
| 开关系列 | 名称     |
| K9   | 防水微动开关 |

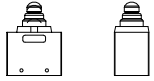
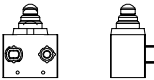
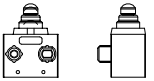
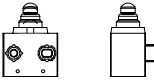
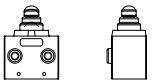
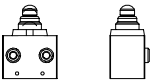
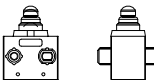
| 编码 | 图示  | 定位类型      |
|----|---|-----------|
| N  |    | 无定位柱      |
| R  |    | 右侧定位柱(右圆) |
| L  |    | 左侧定位柱(右圆) |
| A  |    | 右侧定位柱(左圆) |
| B  |    | 左侧定位柱(左圆) |
| C  |    | 右侧定位柱(双圆) |
| D  |   | 左侧定位柱(双圆) |
| E  |  | 两侧定位柱(左圆) |

| 编码 | 定位柱长度L |
|----|--------|
| D  | 无定位柱   |
| 1  | 0.7MM  |
| 2  | 1.0MM  |
| 3  | 2.0MM  |
| 4  | 5.0MM  |

| 编码 | 线材长度L |
|----|-------|
| 0  | 无线材省略 |
| A  | 300mm |
| B  | 200mm |
| 其它 | ...   |

| 流水号 | 电线规格           |
|-----|----------------|
| 0   | 无线材省略          |
| 1   | UL1007 22AWG美标 |
| 2   | UL1007 24AWG美标 |

| 编码 | 触点类型       |
|----|------------|
| 1  | 常开 SPST-NO |
| 2  | 常闭 SPST-NC |

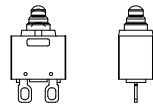
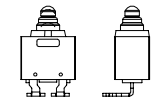
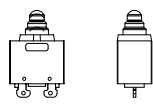
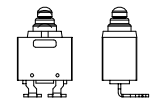
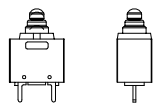
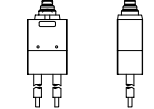
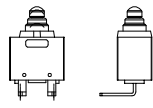
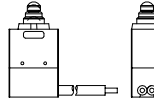
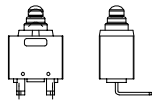
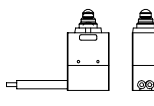
| 编码 | 端子类型  | 编码 | 端子类型  |
|----|---|----|---|
| A  |   | E  |   |
| B  |  | F  |  |
| P  |  | W  |  |
| R  |  | X  |  |
| L  |  | Y  |  |

## X-ON Electronics

Largest Supplier of Electrical and Electronic Components

*Click to view similar products for [Basic / Snap Action Switches](#) category:*

*Click to view products by [HRO parts manufacturer](#):*

Other Similar products are found below :

[5SM901-S12](#) [5SM9-S12N195](#) [602EN532](#) [602EN535-RB](#) [602HE5-RB1](#) [604HE223-6B](#) [624HE17-RB](#) [6HM82](#) [6SE1](#) [6SX1-H58](#) [71051](#) [714-0293](#) [MBH2731](#) [79211923](#) [79218589](#) [MIL30126AB6BBMD4A12XAU](#) [ML-1155](#) [ML-1376](#) [831010C3.0](#) [831090C2.EL](#) [83131904](#) [84212012](#) [8AS239](#) [8HM73-3](#) [8SX26-H33](#) [914CE1-6G](#) [11SM1077-H4](#) [11SM1077-H58](#) [11SM1-TN107](#) [11SM405](#) [11SM703-T](#) [11SM8423-H2](#) [11SX37-T](#) [11SX48-H58](#) [11SM2442-T](#) [11SM76-T](#) [11SM77-H58](#) [11SM77-T](#) [11SM863-T](#) [11SM866](#) [121EN188-R](#) [1245.0120](#) [125EN56-RB](#) [D433V3RD](#) [1267.0101](#) [1267.7101](#) [D4BFC1](#) [12SM4-T2](#) [12SX2-T2](#) [1298.0101](#)