

定制款，尾接端子壳

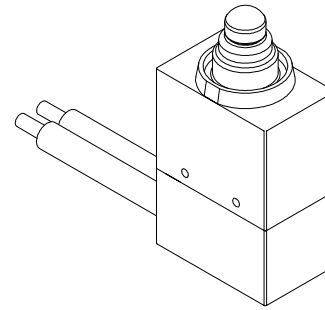

NOTE:

- 1.Rating:DC12V 0.1A
- 2.Operating froce:150gf MAX
- 3.Life:10,000

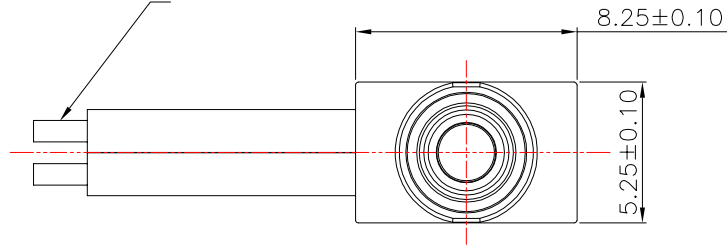

COM/NC:UL1571 28AWG

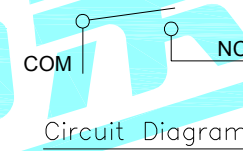
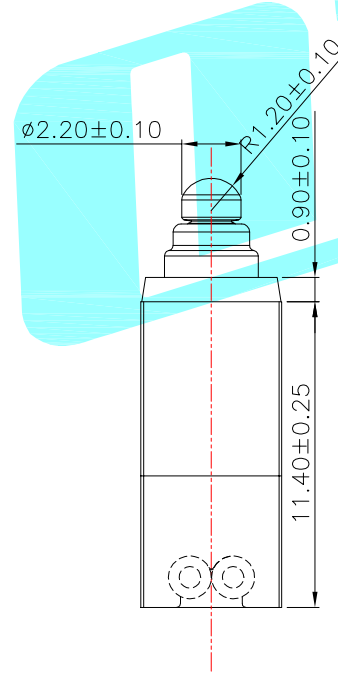
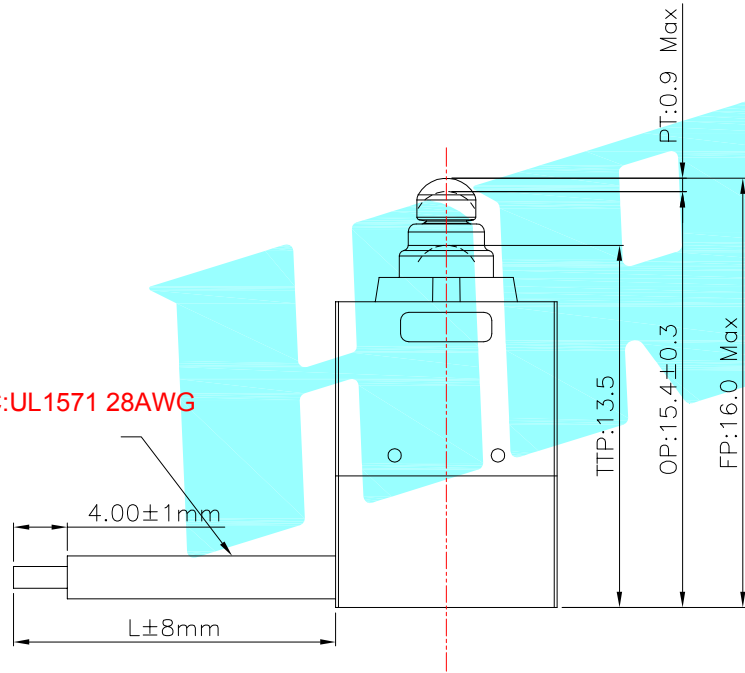

Part No.	Wire color	L	Terminal
K9-1804ND-Y14E	Blue/Black	200	1.5mm 2P
K9-1804ND-Y14F	Green/Black	275	1.5mm 2P
K9-1804ND-Y14G	Yellow/Black	380	1.5mm 3P

⑥	Shrapnel	—	1	Brass	Plating silver	—
⑤	Sealed Circle	—	1	Silicone Rubber	—	—
④	Terminal	—	2	Brass(0.50t)	Plating silver	—
③	Plunger	—	1	POM	Black	—
②	Case	—	1	PA	Black	—
①	Cover	—	1	PA	Black	—
ITEM	PART NAME	TER'NO.	QTY.	MATERIAL	FINISHING	REMARK

APPROVALS		DATE		HRO 韓榮® ELECTRONICS CO.,LTD		
DRAWN	LIUCAN	2023.2.6		TITLE:	MICRO SWITCHS	
CHECKED				PART NO.		
APPROVALS				UNIT: mm	SCALE: 1:1	PROJ:
TOLERANCES ARE		30~以上	±0.30	ANGLE	DRAWING NO.	SHEET 1 OF 1
		10~30	±0.20			
		5~10	±0.15			
		~ 5	±0.10			

ECN NO.	REV.	DATE.	DESCRIPTION.	CHANGE.	CHECK.	APPRO.
	A		NEW			

K9-1804选型表

K9-1804ND-X12A

开关系列	名称
K9	防水微动开关

编码	图示	定位类型
N		无定位柱
R		右侧定位柱(右圆)
L		左侧定位柱(右圆)
A		右侧定位柱(左圆)
B		左侧定位柱(左圆)
C		右侧定位柱(双圆)
D		左侧定位柱(双圆)
E		两侧定位柱(左圆)

编码	定位柱长度L
D	无定位柱
1	0.7MM
2	1.0MM
3	2.0MM
4	5.0MM

编码	线材长度L
0	无线材省略
A	300mm
B	200mm
其它	...

流水号	电线规格
0	无线材省略
1	UL1007 22AWG美标
2	UL1007 24AWG美标

编码	触点类型
1	常开 SPST-NO
2	常闭 SPST-NC

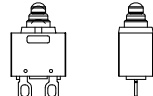
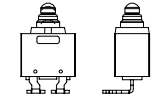
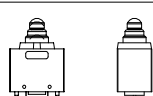
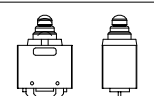
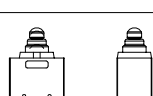
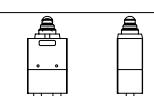
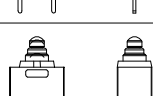
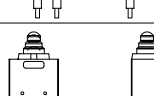
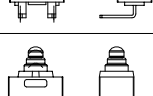
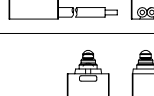
编码	端子类型	编码	端子类型
A		E	
B		F	
P		W	
R		X	
L		Y	

X-ON Electronics

Largest Supplier of Electrical and Electronic Components

Click to view similar products for [Basic / Snap Action Switches](#) category:

Click to view products by [HRO parts manufacturer](#):

Other Similar products are found below :

[5SM901-S12](#) [5SM9-S12N195](#) [602EN532](#) [602EN535-RB](#) [602HE5-RB1](#) [604HE223-6B](#) [624HE17-RB](#) [6HM82](#) [6SE1](#) [6SX1-H58](#) [71051](#) [714-0293](#) [MBH2731](#) [79211923](#) [79218589](#) [MIL30126AB6BBMD4A12XAU](#) [ML-1155](#) [ML-1376](#) [831010C3.0](#) [831090C2.EL](#) [83131904](#) [84212012](#) [8AS239](#) [8HM73-3](#) [8SX26-H33](#) [914CE1-6G](#) [11SM1077-H4](#) [11SM1077-H58](#) [11SM1-TN107](#) [11SM405](#) [11SM703-T](#) [11SM8423-H2](#) [11SX37-T](#) [11SX48-H58](#) [11SM2442-T](#) [11SM76-T](#) [11SM77-H58](#) [11SM77-T](#) [11SM863-T](#) [11SM866](#) [121EN188-R](#) [1245.0120](#) [125EN56-RB](#) [D433V3RD](#) [1267.0101](#) [1267.7101](#) [D4BFC1](#) [12SM4-T2](#) [12SX2-T2](#) [1298.0101](#)