

ROHS

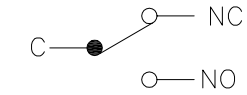

Circuit Diagram

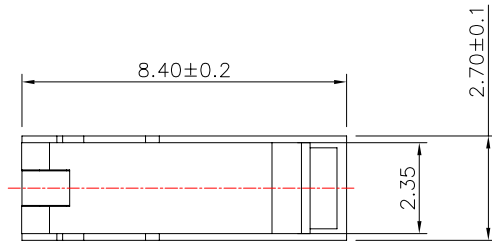
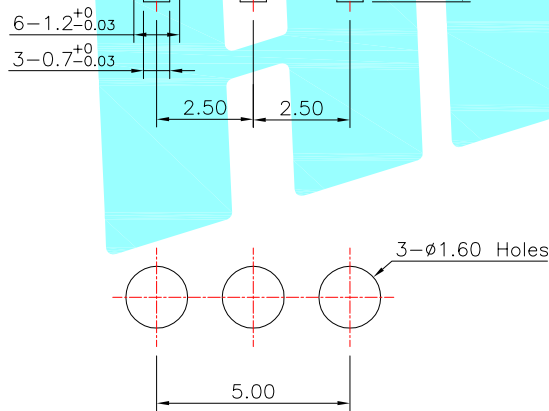
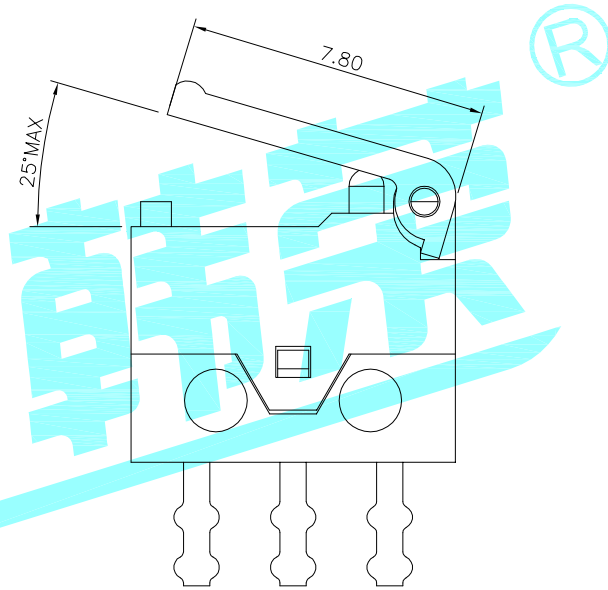
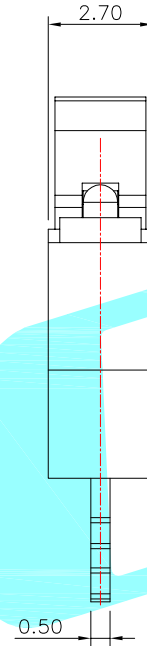
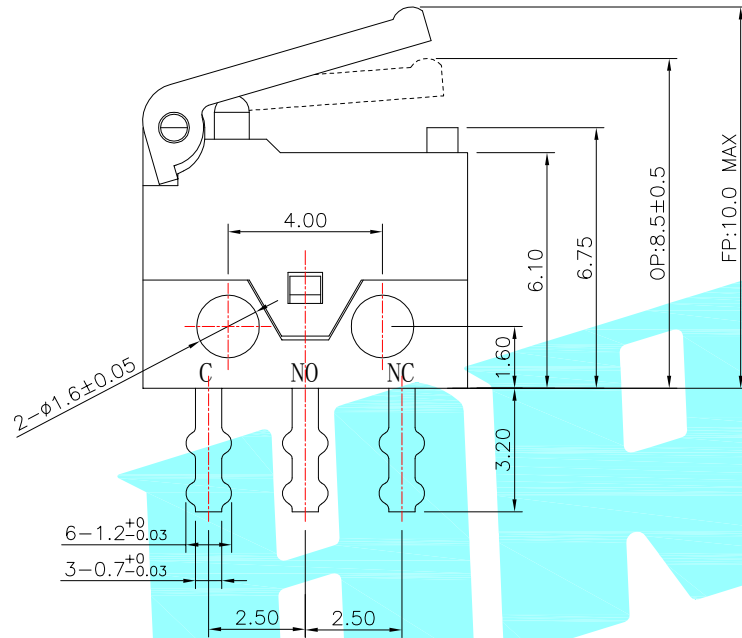

PCB Layout(Pattern side)

NOTE:
 Rating: DC 30V 100mA
 Operating Force: 50gf Max
 Lifetime: 10,000 Cycles

| ⑦ | Touch Point | — | 1 | Silver Alloy | Natural | — |
|------|--------------|---------|------|------------------|-----------|--------|
| ⑥ | Spring Plate | — | 1 | Beryllium copper | Natural | — |
| ⑤ | Terminal | — | 3 | Brass | Ag Plated | — |
| ④ | Housing | — | 1 | Nylon | Black | — |
| ③ | Cover | — | 1 | Nylon | Black | — |
| ② | Knob | — | 1 | PBT | White | — |
| ① | Lever | — | 1 | Nylon | Black | — |
| ITEM | PART NAME | TER'NO. | QTY. | MATERIAL | FINISHING | REMARK |

| | | | | | | |
|----------------|--------|-----------|---|---------------------------|----------|---------------------|
| APPROVALS | | DATE | | ELECTRONICS CO.,LTD | | |
| DRAWN | LIUCAN | 2022.3.14 | | | | |
| CHECKED | | | | TITLE: MICRO SWITCHES | | |
| APPROVALS | | | | PART NO. K9-8227Y-D3DF-1B | | |
| TOLERANCES ARE | | | 30~以上 ±0.30 10~30 ±0.20 5~10 ±0.15 ~ 5 ±0.10 | ANGLE ±2' | UNIT: mm | SCALE: 1:1 |
| ECN NO. | | | | DRAWING NO. | | PROJ: SHEET 1 OF 1 |

| _____ | A | _____ | NEW | _____ | _____ | _____ |
|---------|------|-------|--------------|---------|--------|--------|
| ECN NO. | REV. | DATE. | DESCRIPTION. | CHANGE. | CHECK. | APPRO. |

K9-8227□选型表

K9-8227N-L3DN-1B

| 开关系列 | 名称 |
|------|--------|
| K9 | 超小微动开关 |

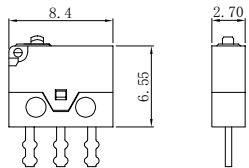

| 编码 | 图示 | 定位类型 |
|----|----|-------|
| Y | | 有定位孔 |
| N | | 无定位孔 |
| L | | 左侧定位柱 |
| R | | 右侧定位柱 |

| 编码 | 端子类型 |
|----|------|
| D | |
| L | |
| R | |

| 编码 | 端子脚长L |
|----|-------|
| 3 | 3.2MM |
| 4 | 4.0MM |
| 5 | 5.1MM |

| 编码 | 底座颜色 | 电气寿命 | 机械寿命 |
|----|------|------|------|
| B | 黑色 | 1W | 2W |
| W | 白色 | 2W | 30W |
| G | 灰色 | 30W | 30W |
| H | 橙色 | 100W | 100W |

| 编码 | 触点材质 | 额定负载 |
|----|-----------|---------------------------------|
| 1 | 银合金 | DC 30V 0.1A |
| 2 | 银合金 镀金 | 定制款 DC15V 1A 电气寿命2W, 机械寿命30W |

| 编码 | 手柄类型 | 编码 | 手柄类型 |
|----|------|----|------|
| N | 00 | D | 04 |
| A | 01 | E | 05 |
| B | 02 | F | 06 |
| C | 03 | G | 07 |
| H | | | |

| 编码 | 触点类型 |
|----|------------|
| D | 常开/常闭 SPDT |
| B | 常开 SPST-NO |
| C | 常闭 SPST-NC |

X-ON Electronics

Largest Supplier of Electrical and Electronic Components

Click to view similar products for [Basic / Snap Action Switches](#) category:

Click to view products by [HRO parts manufacturer](#):

Other Similar products are found below :

[5SM901-S12](#) [5SM9-S12N195](#) [602EN532](#) [602EN535-RB](#) [602HE5-RB1](#) [604HE223-6B](#) [624HE17-RB](#) [6HM82](#) [6SE1](#) [6SX1-H58](#) [70500216](#)
[70599106](#) [71051](#) [714-0293](#) [MBH2731](#) [79211923](#) [79218589](#) [MIL30126AB6BBMD4A12XAU](#) [ML-1155](#) [ML-1376](#) [831010C3.0](#) [8AS239](#)
[8HM73-3](#) [8SX26-H33](#) [914CE1-6G](#) [11SM1077-H4](#) [11SM1077-H58](#) [11SM1-TN107](#) [11SM405](#) [11SM703-T](#) [11SM8423-H2](#) [11SX37-T](#)
[11SX48-H58](#) [11SM2442-T](#) [11SM76-T](#) [11SM77-H58](#) [11SM77-T](#) [11SM863-T](#) [11SM866](#) [A831700C7.0](#) [121EN188-R](#) [1245.0120](#) [125EN56-](#)
[RB](#) [D433V3RD](#) [1267.0101](#) [1267.7101](#) [D4BFC1](#) [12SM4-T2](#) [12SX2-T2](#) [1298.0101](#)