

ROHS

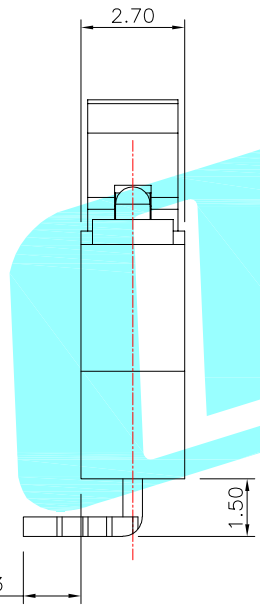

左弯脚

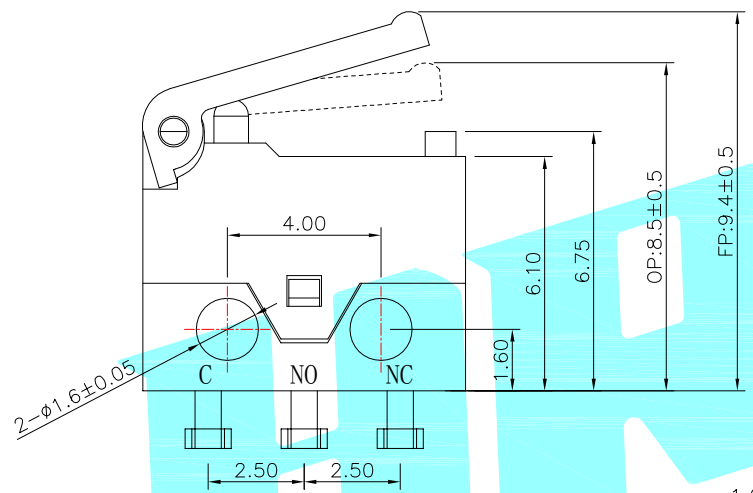
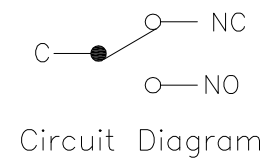
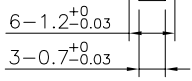
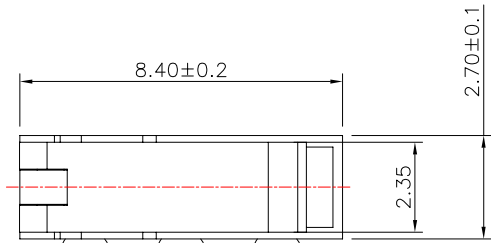
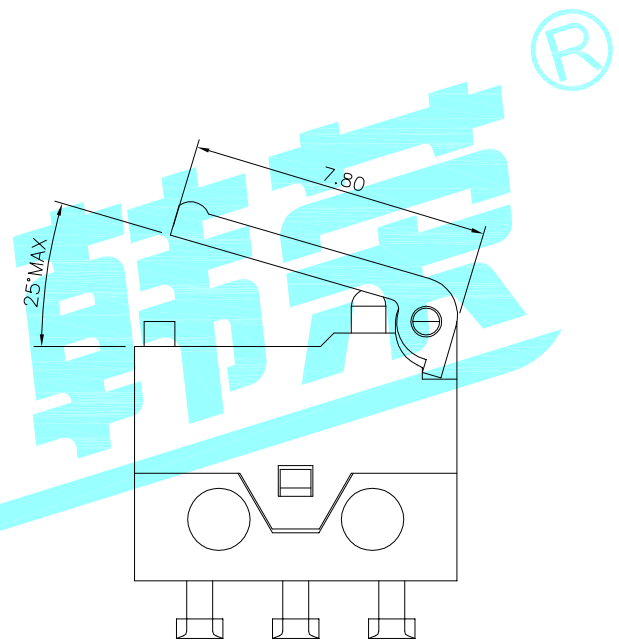

NOTE:
 Rating: DC 30V 100mA
 Operating Force: 50gf Max
 Lifetime: 10,000 Cycles

⑦	Touch Point	—	1	Silver Alloy	Natural	—
⑥	Spring Plate	—	1	Beryllium copper	Natural	—
⑤	Terminal	—	3	Brass	Ag Plated	—
④	Housing	—	1	Nylon	Black	—
③	Cover	—	1	Nylon	Black	—
②	Knob	—	1	PBT	White	—
①	Lever	—	1	Nylon	Black	—
ITEM	PART NAME	TER'NO.	QTY.	MATERIAL	FINISHING	REMARK

APPROVALS		DATE		 ELECTRONICS CO.,LTD			
DRAWN	LIUCAN	2022.9.6					
CHECKED				TITLE: MICRO SWITCHS			
APPROVALS				PART NO. K9-8227Y-L3DF-1B			
TOLERANCES ARE		30~以上	±0.30	ANGLE	UNIT: mm	SCALE: 1:1	
		10~30	±0.20				
		5~10	±0.15				
		~ 5	±0.10	±2'	DRAWING NO.	—	PROJ:
ECN NO.	REV. A	DATE.	NEW	DESCRIPTION.	CHANGE.	CHECK.	APPRO.

ECN NO.	REV. A	DATE.	NEW	DESCRIPTION.	CHANGE.	CHECK.	APPRO.
---------	--------	-------	-----	--------------	---------	--------	--------

K9-8227□选型表

K9-8227N-L3DN-1B

开关系列	名称
K9	超小微动开关

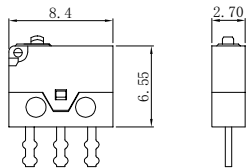

编码	图示	定位类型
Y		有定位孔
N		无定位孔
L		左侧定位柱
R		右侧定位柱

编码	端子类型
D	
L	
R	

编码	端子脚长L
3	3.2MM
4	4.0MM
5	5.1MM

编码	底座颜色	电气寿命	机械寿命
B	黑色	1W	2W
W	白色	2W	30W
G	灰色	30W	30W
H	橙色	100W	100W

编码	触点材质	额定负载
1	银合金	DC 30V 0.1A
2	银合金 镀金	定制款 DC15V 1A 电气寿命2W, 机械寿命30W

编码	手柄类型	编码	手柄类型
N	00	D	04
A	01	E	05
B	02	F	06
C	03	G	07
H	08		

编码	触点类型
D	常开/常闭 SPDT
B	常开 SPST-NO
C	常闭 SPST-NC

X-ON Electronics

Largest Supplier of Electrical and Electronic Components

Click to view similar products for [Basic / Snap Action Switches](#) category:

Click to view products by [HRO parts manufacturer](#):

Other Similar products are found below :

[5SM901-S12](#) [5SM9-S12N195](#) [602EN532](#) [602EN535-RB](#) [602HE5-RB1](#) [604HE223-6B](#) [624HE17-RB](#) [6HM82](#) [6SE1](#) [6SX1-H58](#) [70500216](#)
[70599106](#) [71051](#) [714-0293](#) [MBH2731](#) [79211923](#) [79218589](#) [MIL30126AB6BBMD4A12XAU](#) [ML-1155](#) [ML-1376](#) [831010C3.0](#) [8AS239](#)
[8HM73-3](#) [8SX26-H33](#) [914CE1-6G](#) [11SM1077-H4](#) [11SM1077-H58](#) [11SM1-TN107](#) [11SM405](#) [11SM703-T](#) [11SM8423-H2](#) [11SX37-T](#)
[11SX48-H58](#) [11SM2442-T](#) [11SM76-T](#) [11SM77-H58](#) [11SM77-T](#) [11SM863-T](#) [11SM866](#) [A831700C7.0](#) [121EN188-R](#) [1245.0120](#) [125EN56-](#)
[RB](#) [D433V3RD](#) [1267.0101](#) [1267.7101](#) [D4BFC1](#) [12SM4-T2](#) [12SX2-T2](#) [1298.0101](#)