

ROHS

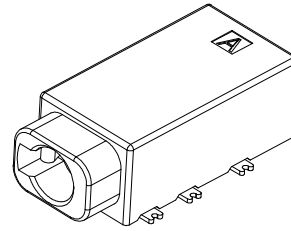

3D VIEW

1. CONTACT CURRENT RATING: 1A.
2. CONTACT RESISTANCE: 100 mΩ MAX.;
3. INSULATION RESISTANCE: 100MΩ MIN.;
4. DIELECTRIC WITHSTANDING: 500V AC MIN.;
5. DURABILITY: 5,000 CYCLES MIN.;
6. CONNECTOR MATING FORCES: 30N MAX.;
7. CONNECTOR UNMATING FORCES: 3N MIN.;
8. TERPROOF LEVEL: IPX7;

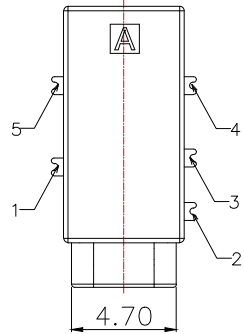
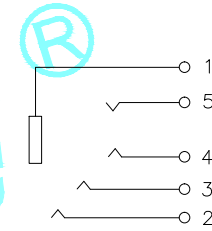
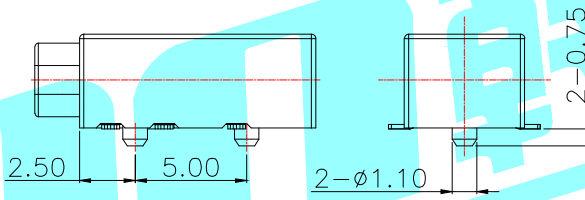
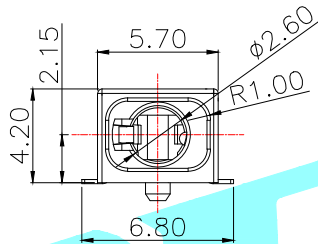
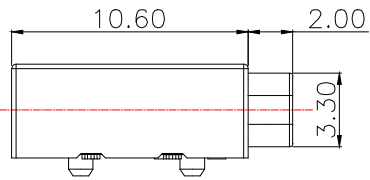

Schematic

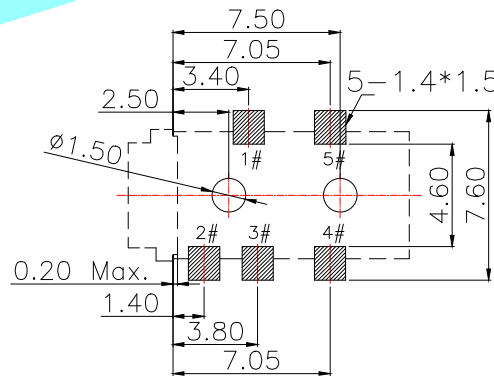
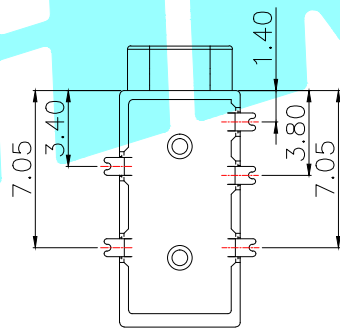

RECOMMENDED P.C.B LAYOUT
TOP VIEW (TOLRANCE:±0.05)

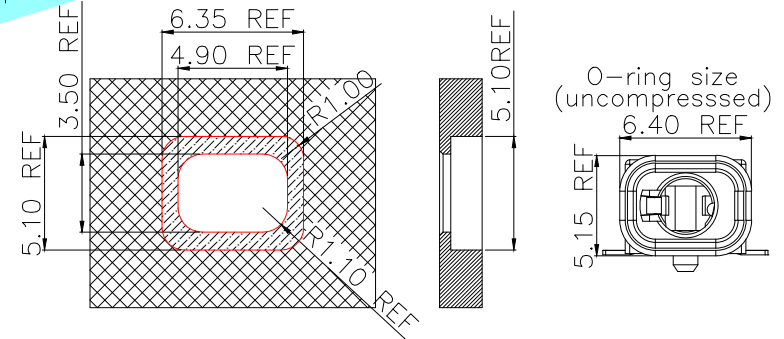

面板开孔参考尺寸

③	Silica gel	—	1	Silica gel	Black	—
②	Terminal	—	5	Phosphor bronze	Au Plating	—
①	Housing	—	1	HTP	Black	—
ITEM	PART NAME	TER'NO.	QTY.	MATERIAL	FINISHING	REMARK

APPROVALS		DATE		 ELECTRONICS CO.,LTD		
DRAWN	LIUCAN	2021.3.26				
CHECKED				TITLE: PHONE JACKES		
APPROVALS				PART NO. PJ-259		
TOLERANCES ARE		30~以上	±0.30	ANGLE	UNIT: mm	SCALE: 1:1
		10~30	±0.20			
		5~10	±0.15			
		~ 5	±0.10	±2'	DRAWING NO.	
				PROJ:		SHEET 1 OF 1

_____	A	_____	NEW	_____	_____	_____
ECN NO.	REV.	DATE.	DESCRIPTION.	CHANGE.	CHECK.	APPRO.

X-ON Electronics

Largest Supplier of Electrical and Electronic Components

Click to view similar products for [Phone Connectors](#) category:

Click to view products by [HRO parts manufacturer](#):

Other Similar products are found below :

[R4F](#) [14412GX](#) [E12BPKG](#) [MT333X](#) [171-3302-EX](#) [NC3MG-V](#) [NP2RX-AU-SILENT-D](#) [JM2PB-AU BULK](#) [S2674](#) [280L](#) [RJ5VI-S](#) [TM1R-AU](#) [TM2PJ-AU](#) [TM2PJ-AU BULK](#) [TS3PBJ-AU](#) [TS3PBMJ-AU](#) [MP-101](#) [54B](#) [T10711](#) [MT334F](#) [NJ3FP6F-P](#) [NPX-PROMO](#) [JS3PB-AU BULK](#) [XMT332A](#) [114BPCSX](#) [CMT334B](#) [AA0-A4830-A00](#) [PJ-218](#) [PJ-320-3P SMT](#) [PJ-321A](#) [PJ-393-8P](#) [KH-PJ-327D-SMT](#) [PJ-320D](#) [PJ-3106M](#) [PJ-376](#) [PJ-624](#) [PJ-339](#) [PJ-3200B](#) [PJ-307B-1.3-01](#) [PJ-324](#) [PJ-324M](#) [PJ-313D](#) [PJ-227](#) [PJ-343 Red](#) [PJ-3106AC1](#) [PJ-3505A](#) [PJ-321](#) [KH-PJ-307-5P](#) [PJ-389](#) [PJ-368-R](#)