

ROHS

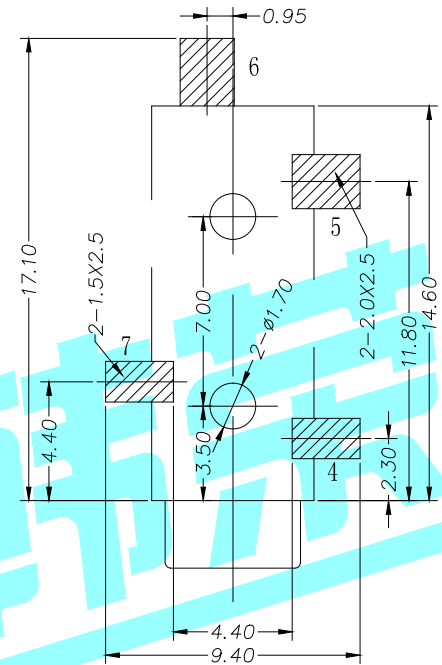

P.C.B Layout (copper-sided view)

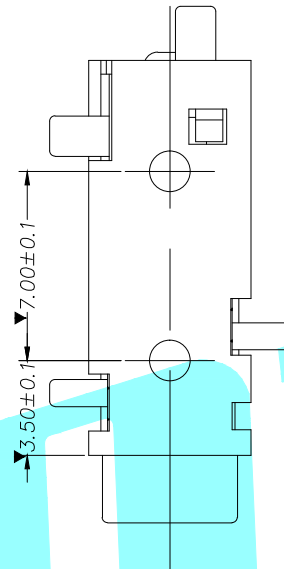
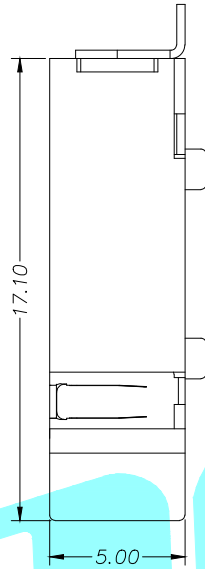
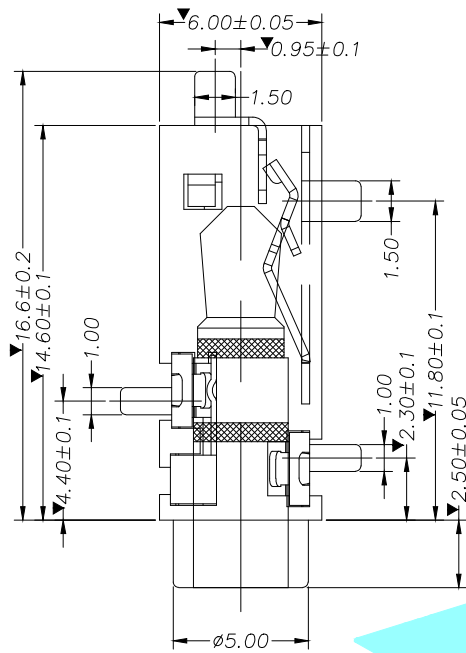
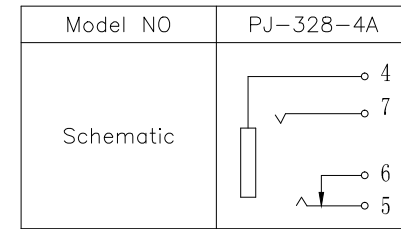
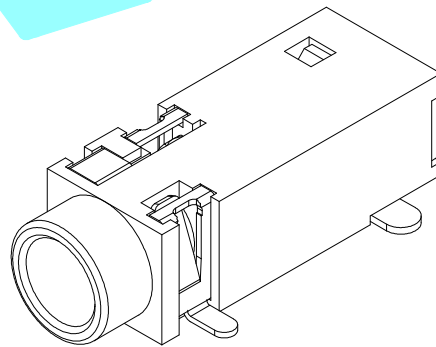
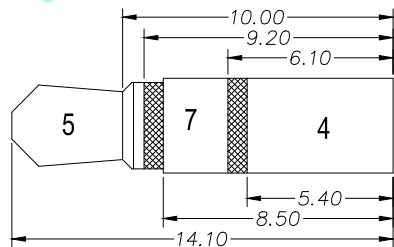
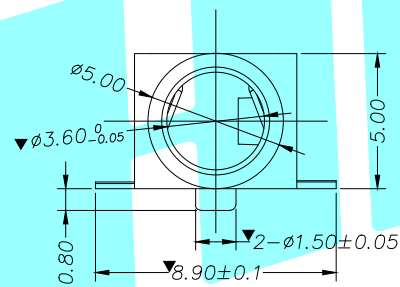

Rating:0.5A 30V DC
 Contact Resistance:100 mΩ Max.
 Operating temperature:-20℃~70℃
 Operating force:3-20N
 Operating Life:5,000cycles

②	Terminal	4	Phosphor bronze	Ag Plating																									
①	Housing	1	PPA	Black																									
ITEM	PART NAME	TER'NO.	QTY.	MATERIAL	FINISHING	REMARK																							
APPROVALS		DATE		 ELECTRONICS CO.,LTD																									
DRAWN	J.X.Zhang	2013/11/11					TITLE:	PHONE JACKES																					
CHECKED				PART NO.	PJ-328-4A																								
APPROVALS				TOLERANCES ARE	<table border="1"> <tr> <td>30~以上</td> <td>±0.30</td> <td>ANGLE</td> <td>UNIT: mm</td> <td>SCALE: 1:1</td> <td>PROJ: </td> </tr> <tr> <td>10~30</td> <td>±0.20</td> <td></td> <td></td> <td></td> <td></td> </tr> <tr> <td>5~10</td> <td>±0.15</td> <td></td> <td></td> <td></td> <td></td> </tr> <tr> <td>~ 5</td> <td>±0.10</td> <td></td> <td></td> <td></td> <td></td> </tr> </table>	30~以上	±0.30	ANGLE	UNIT: mm	SCALE: 1:1	PROJ:	10~30	±0.20					5~10	±0.15					~ 5	±0.10				
30~以上	±0.30	ANGLE	UNIT: mm	SCALE: 1:1	PROJ:																								
10~30	±0.20																												
5~10	±0.15																												
~ 5	±0.10																												
ECN NO.	REV.	DATE.	DESCRIPTION.	CHANGE.	CHECK.	APPRO.																							

_____	A	_____	NEW	_____	_____	_____
ECN NO.	REV.	DATE.	DESCRIPTION.	CHANGE.	CHECK.	APPRO.



X-ON Electronics

Largest Supplier of Electrical and Electronic Components

Click to view similar products for [HDMI, Displayport & DVI Connectors](#) category:

Click to view products by [HRO parts manufacturer](#):

Other Similar products are found below :

[30-528](#) [30-504](#) [33DVIR-24S1B](#) [47648-2000](#) [TC142X](#) [1932649-1](#) [HAGBH](#) [AABII](#) [ABIBG](#) [AAIBH](#) [52355](#) [XHLJQ-00026](#) [HDMI-019R](#)
[G46M2013201AWEU](#) [ST-0277D00-052-142](#) [HC-PJ-320A-3P-D](#) [HC-PJ-3133-5P-D](#) [PJ-342](#) [141](#) [PJ-320A-4P DIP](#) [HC-PJ-325C-5P](#) [HC-PJ-](#)
[320D-4P-S](#) [HC-PJ-3133-6P-S](#) [D-SUB-DR-9PCM-CB](#) [ST-0275S00-082-182](#) [HC-PJ-320A-4P-D](#) [HC-PJ-325A-5P](#) [HC-PJ-3134-6P-D](#) [HDR-](#)
[HX-102DIP](#) [HDMI-GD-121PWB](#) [C2939191](#) [C2939584](#) [PJ-208](#) [PJ-2040](#) [PJ-3580A-6A](#) [PJ-399M](#) [PJ-3200A-3A](#) [PJ-328B-4B](#) [PJ-3930-7A](#)
[PJ-615-5A](#) [PJ-332-6A](#) [KH-HDMI-0001](#) [KH-PJ-209-SMT](#) [KH-HDMI-0035-XK](#) [KH-PJ-328A-5P](#) [KH-PJ-322](#) [KH-PJ-327E-SMT](#) [KH-PJ-](#)
[320A-5.6](#) [KH-HDR15P-F3.08](#) [KH-HDMI-0005A-SMT](#) [KH-HDMI-0021-JBS](#)