

ROHS

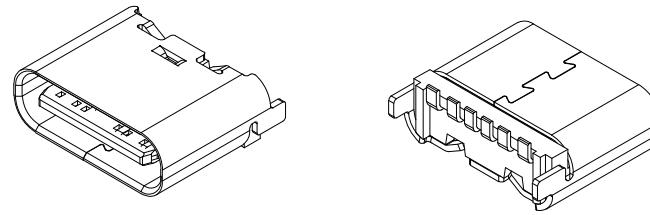

NOTE:

- 1.MATERIAL SPECIFICATION:
 - 1.HOUSING: HIGH TEMPERATURE RESISTANT PLASTIC,UL94 V-0.
 - 2.CONTACTS: COPPER ALLOY
- 2.PLATING SPECIFICATION:
 - 2-1.CONTACTS:
 - Ni 50u" MIN. UNDER PLATED OVER ALL.
 - Au PLATED ON THE FUNCTIONAL AREA OF CONTACT.
 - (GOLD PLATING THICKNESS FOLLOW THE P/N)
 - GOLD FLASH PLATING ON SOLDER AREA
 - 2-2.FRONT SHELL:
 - Ni 30u" MIN. UNDER PLATED OVER ALL.
- 3.MECHANICAL PERFORMANCE,
 - 3-1.INSERTION FORCE: 0.5~2.0kgf.
 - 3-2.REMOVAL FORCE: 0.8kgf~2.0kgf.
 - 3-3.DURABILITY: 3000 CYCLES.
- 4.ELECTRICAL PERFORMANCE,
 - 4-1. CURRENT RATING: 5.0A
VOLTAGE RATING: 20V
 - 4-2.INSULATION RESISTANCE: 100MΩ MIN
 - 4-3.DIELECTRIC WITHSTAND VOLTAGE,AC 100V FOR 1 MINUTE.
 - 4-4.LOW CONTACT RESISTANCE: INITIAL 40MΩ /AFTER 50MΩ
5. ENVIRONMENTAL PERFORMANCE:
 - OPERATING TEMPERATURE: -30°C~+80°C.
- 6.IR REFLOW:
 - THE PEAK TEMPERATURE ON THE BOARD SHALL BE MAINTAINED FOR 10 SECONDS AT 260°C.

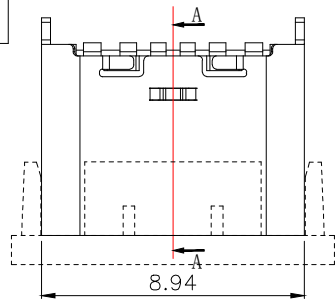
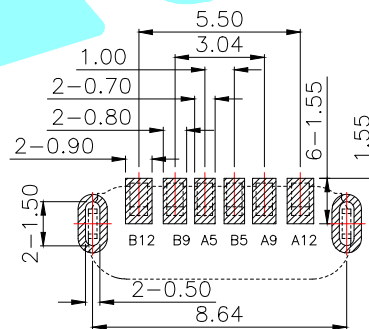
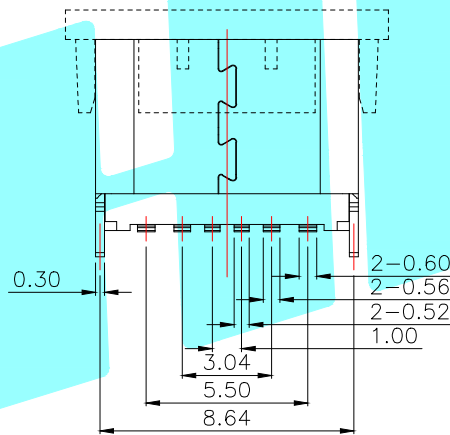
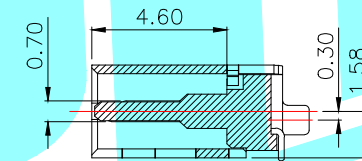
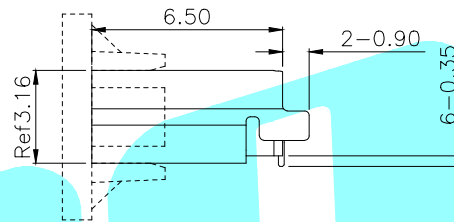
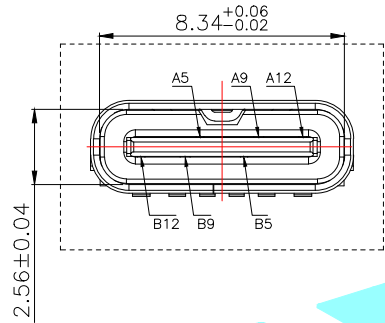

A5	CC1	B12	GND
A9	VBUS	B9	VBUS
A12	GND	B5	CC2
PIN	SIGNAL NAME	PIN	SIGNAL NAME

RECOMMEND P.C.B LAYOUT(COMPONENT SIDE)
TOLERANCE FOR PCB LAYOUT IS ± 0.05

APPROVALS		DATE	 ELECTRONICS CO.,LTD			
DRAWN	LIUCAN	2021.6.23				
CHECKED			TITLE:	USB CONNECTOR		
APPROVALS			PART NO.	TYPE-C-31-D-04		
TOLERANCES ARE	30~以上	±0.30	ANGLE	UNIT: mm	SCALE: 1:1	PROJ:
	10~30	±0.25				
	5~10	±0.20	±2'	DRAWING NO.		SHEET 1 OF 1
	~ 5	±0.15				

ECN NO.	REV.	DATE.	DESCRIPTION.	CHANGE.	CHECK.	APPRO.
	A		NEW			

X-ON Electronics

Largest Supplier of Electrical and Electronic Components

Click to view similar products for [USB Connectors](#) category:

Click to view products by [HRO parts manufacturer](#):

Other Similar products are found below :

[950](#) [A-USB B-TOP-C](#) [MUSBA511N5](#) [MUSBC111M5](#) [MUSBD11135](#) [17-200721](#) [217450-1](#) [KMBVX-TH-5S-B30](#) [896-30-004-00-000000](#)
[KUSBX-AS2N-W](#) [KUSBX-SMT2AP1S-W30](#) [935](#) [957](#) [30-498-6](#) [SK-60A-2](#) [1734082-1](#) [30-1574](#) [30-470](#) [30-489](#) [30-541](#) [30-572-3](#) [A-USB](#)
[A-2P-C](#) [MIKROE-1451](#) [USBFTV2PEM2G](#) [USBFTVSCCG](#) [4689-1](#) [1-1734084-2](#) [MUSBC11135](#) [USBF21ZNSCC](#) [USBBFTV6ZC](#)
[MUSBB151341](#) [10135326-001LF](#) [M9177/3-1](#) [TJ-105](#) [USB-A-S-F-B-VT](#) [4198](#) [690-024-633-031](#) [UB-20PMFP-LC7001](#) [USBFTVC6MRG](#)
[UA-20BMFA-SL8001](#) [17-200011](#) [USBFTVC7ZC](#) [UB-20AFMM-LL7A01](#) [USBFTVC2MN](#) [CAP-WCCMLPB1](#) [1310-1031-01](#) [2041386-1](#)
[2274475-3](#) [UB-20BMFA-SL8001](#) [UB-20PMFP-SC8003](#)