

# ROHS

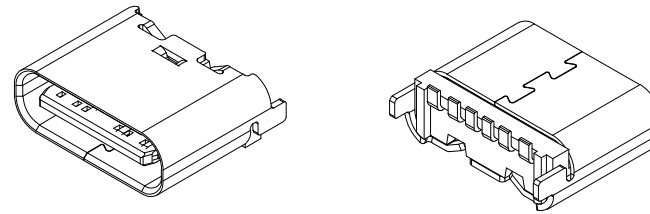

NOTE:

- 1.MATERIAL SPECIFICATION:
  - 1.HOUSING: HIGH TEMPERATURE RESISTANT PLASTIC, UL94 V-0.
  - 2.CONTACTS: COPPER ALLOY
- 2.PLATING SPECIFICATION:
  - 2-1.CONTACTS:
    - Ni 50u" MIN. UNDER PLATED OVER ALL.
    - Au PLATED ON THE FUNCTIONAL AREA OF CONTACT.
    - (GOLD PLATING THICKNESS FOLLOW THE P/N)
    - GOLD FLASH PLATING ON SOLDER AREA
  - 2-2.FRONT SHELL:
    - Ni 30u" MIN. UNDER PLATED OVER ALL.
- 3.MECHANICAL PERFORMANCE,
  - 3-1.INSERTION FORCE: 0.5~2.0kgf.
  - 3-2.REMOVAL FORCE: 0.8kgf~2.0kgf.
  - 3-3.DURABILITY: 3000 CYCLES.
- 4.ELECTRICAL PERFORMANCE,
  - 4-1. CURRENT RATING: 5.0A  
VOLTAGE RATING: 20V
  - 4-2.INSULATION RESISTANCE: 100MΩ MIN
  - 4-3.DIELECTRIC WITHSTAND VOLTAGE, AC 100V FOR 1 MINUTE.
  - 4-4.LOW CONTACT RESISTANCE: INITIAL 40MΩ /AFTER 50MΩ
5. ENVIRONMENTAL PERFORMANCE:
  - OPERATING TEMPERATURE: -30°C~+80°C.
- 6.IR REFLOW:
  - THE PEAK TEMPERATURE ON THE BOARD SHALL BE MAINTAINED FOR 10 SECONDS AT 260°C.

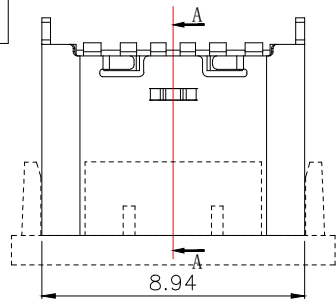
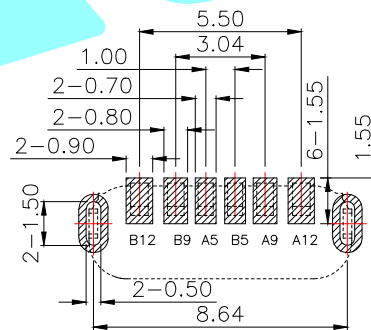
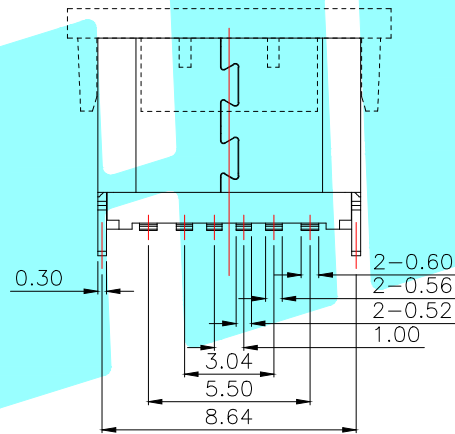
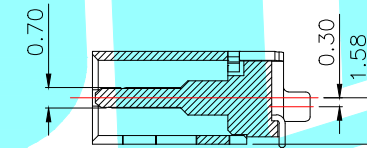
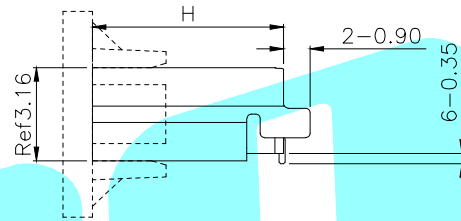
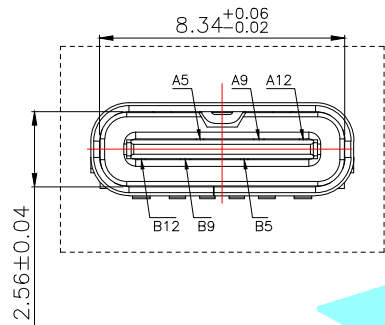

|     |             |     |             |
|-----|-------------|-----|-------------|
| A5  | CC1         | B12 | GND         |
| A9  | VBUS        | B9  | VBUS        |
| A12 | GND         | B5  | CC2         |
| PIN | SIGNAL NAME | PIN | SIGNAL NAME |

|                |     |
|----------------|-----|
| PART NO        | H   |
| TYPE-C-31-D-04 | 6.5 |
| TYPE-C-31-D-05 | 6.8 |

RECOMMEND P.C.B LAYOUT (COMPONENT SIDE)  
TOLERANCE FOR PCB LAYOUT IS ± 0.05

|                |        |           |              |                          |               |            |             |  |       |              |
|----------------|--------|-----------|--------------|--------------------------|---------------|------------|-------------|--|-------|--------------|
| APPROVALS      |        | DATE      |              | <br>ELECTRONICS CO., LTD |               |            |             |  |       |              |
| DRAWN          | LIUCAN | 2021.6.23 |              |                          |               |            |             |  |       |              |
| CHECKED        |        |           |              | TITLE:                   | USB CONNECTOR |            |             |  |       |              |
| APPROVALS      |        |           |              | PART NO.                 |               |            |             |  |       |              |
| TOLERANCES ARE |        | 30~以上     | ±0.30        | ANGLE                    | UNIT: mm      | SCALE: 1:1 |             |  |       |              |
|                |        | 10~30     | ±0.25        |                          |               |            |             |  |       |              |
|                |        | 5~10      | ±0.20        |                          |               |            |             |  |       |              |
|                |        | ~ 5       | ±0.15        |                          |               |            |             |  |       |              |
|                |        | ±2'       |              |                          |               |            |             |  |       |              |
| ECN NO.        | REV.   | DATE.     | DESCRIPTION. | CHANGE.                  | CHECK.        | APPRO.     | DRAWING NO. |  | PROJ: | SHEET 1 OF 1 |

|         |      |       |              |         |        |        |
|---------|------|-------|--------------|---------|--------|--------|
| ECN NO. | REV. | DATE. | DESCRIPTION. | CHANGE. | CHECK. | APPRO. |
|         | A    |       | NEW          |         |        |        |

## X-ON Electronics

Largest Supplier of Electrical and Electronic Components

*Click to view similar products for [USB Connectors](#) category:*

*Click to view products by [HRO parts manufacturer](#):*

Other Similar products are found below :

[950](#) [A-USB B-TOP-C](#) [MUSBA511N5](#) [MUSBC111M5](#) [MUSBD11135](#) [17-200721](#) [217450-1](#) [KMBVX-TH-5S-B30](#) [896-30-004-00-000000](#)  
[KUSBX-AS2N-W](#) [KUSBX-SMT2AP1S-W30](#) [935](#) [957](#) [30-498-6](#) [SK-60A-2](#) [1734082-1](#) [30-1574](#) [30-470](#) [30-489](#) [30-541](#) [30-572-3](#) [A-USB](#)  
[A-2P-C](#) [MIKROE-1451](#) [USBFTV2PEM2G](#) [USBFTVSCCG](#) [4689-1](#) [1-1734084-2](#) [MUSBC11135](#) [USBF21ZNSCC](#) [USBBFTV6ZC](#)  
[MUSBB151341](#) [10135326-001LF](#) [M9177/3-1](#) [TJ-105](#) [USB-A-S-F-B-VT](#) [4198](#) [690-024-633-031](#) [UB-20PMFP-LC7001](#) [USBFTVC6MRG](#)  
[UA-20BMFA-SL8001](#) [17-200011](#) [USBFTVC7ZC](#) [UB-20AFMM-LL7A01](#) [USBFTVC2MN](#) [CAP-WCCMLPB1](#) [1310-1031-01](#) [2041386-1](#)  
[2274475-3](#) [UB-20BMFA-SL8001](#) [UB-20PMFP-SC8003](#)