

NOTES:

SPECIFICATION:

1. RATING: 3.0V 5.0A
2. VOLTAGE: 100 VAC FOR 1 min
3. TEMPERATURE RANGE: -20 °C ~ 85 °C
4. CONTACT RESISTANCE: 40 MILLIONHM MAX
5. INSULATION RESISTANCE: 100 MEGOHMS MIN.
6. INSERTION FORCE: 5N~20N
7. UNMATING FORCE: 6N~20N
8. DURABILITY: 10,000 CYCLES
9. WATER PROOFNESS: THIS PRODUCT IS BASED ON IPX7.

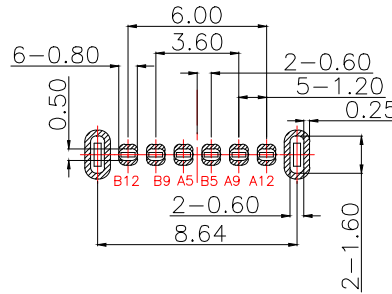
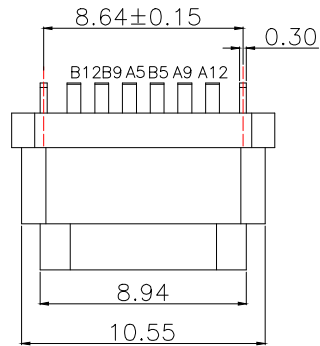

PCB Layout(Pattern side)

A5	CC1	B12	GND
A9	VBUS	B9	VBUS
A12	GND	B5	CC2
PIN	SIGNAL NAME	PIN	SIGNAL NAME

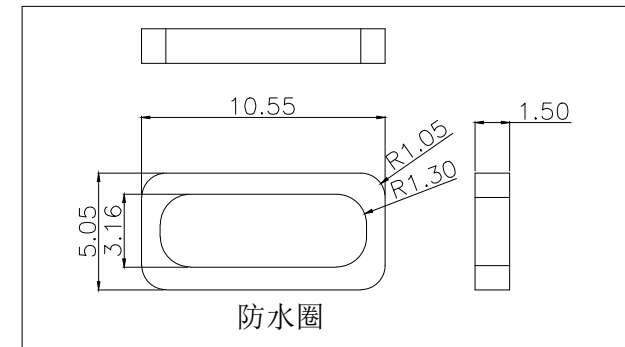
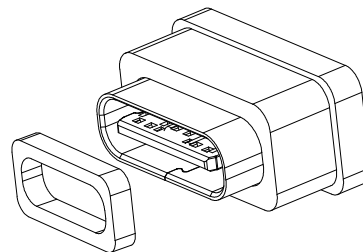
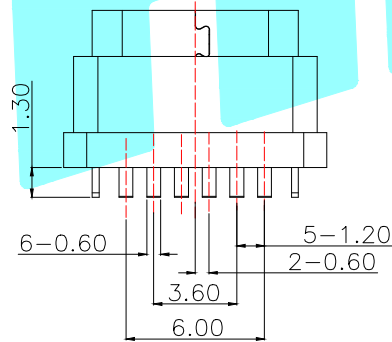
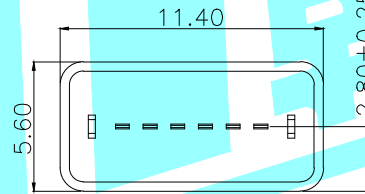
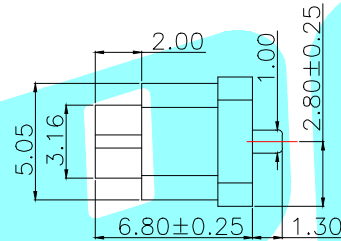
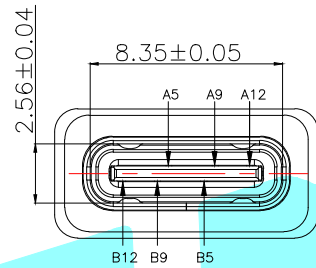

⑤	防水圈	—	1	硅胶	Black
④	Shell	—	1	SUS	Ni Plated
③	Mid Plate	—	1	SUS	Natural
②	Contact	—	1	COPPER ALLOY	TIN/Au/NI Plated
①	Housing	—	1	LCP	Black
ITEM	PART NAME	TER'NO.	QTY.	MATERIAL	FINISHING

APPROVALS		DATE		 ELECTRONICS CO.,LTD		
DRAWN	LIUCAN	2022.8.16				
CHECKED				TITLE:	USB CONNECTOR	
APPROVALS				PART NO.	TYPE-C-31-E-11B	
TOLERANCES ARE	30~以上	±0.30	ANGLE	UNIT: mm	SCALE: 1:1	PROJ:
	10~30	±0.25				
	5~10	±0.20	±2'	DRAWING NO.		SHEET 1 OF 1
	~ 5	±0.15				

_____	A	_____	NEW	_____	_____	_____
ECN NO.	REV.	DATE.	DESCRIPTION.	CHANGE.	CHECK.	APPRO.

## X-ON Electronics

Largest Supplier of Electrical and Electronic Components

*Click to view similar products for [USB Connectors](#) category:*

*Click to view products by [HRO parts manufacturer](#):*

Other Similar products are found below :

[950](#) [A-USB A-LP-SMT-C](#) [A-USB B-TOP-C](#) [MUSBD11135](#) [17-200721](#) [217450-1](#) [KMBVX-TH-5S-B30](#) [KUSBX-AS2N-W](#) [KUSBX-SMT2AP1S-W30](#) [935](#) [957](#) [30-498-6](#) [SK-60A-2](#) [1734082-1](#) [30-470](#) [30-489](#) [30-541](#) [MAB 5 S](#) [A-USB A-2P-C](#) [MIKROE-1451](#)  
[USBFTVSCCG](#) [1-1734084-2](#) [MUSBA81130](#) [NK-27-32SL](#) [NK-L8-22C-5/8](#) [10135326-001LF](#) [4198](#) [690-024-633-031](#) [UB-20PMFP-LC7001](#)  
[17-200011](#) [UB-20AFMM-LL7A01](#) [CAP-WCCMLPB1](#) [CAP-WCCMLPC1](#) [2274475-3](#) [914-614A2025S10200](#) [USB3FTV7SAGF059](#)  
[USB3FTV2SAZNF459](#) [USB3FTV7SAZNF459](#) [HYCW153-USBD05-500B](#) [HYCW219-USBD05-075B](#) [HYCW148-USBD05-117B](#)  
[HYCW149-USBD05-740B](#) [HYCW204-USBD05-108B](#) [HYCW214-USBA04-113B](#) [HYCW213-USBA04-113B](#) [KMMX-BSMT35S-1-B30TR](#)  
[2345986-1](#) [10082141-N340LF](#) [10117836-011LF](#) [GSB3C3133DSYHR](#)