

# ROHS

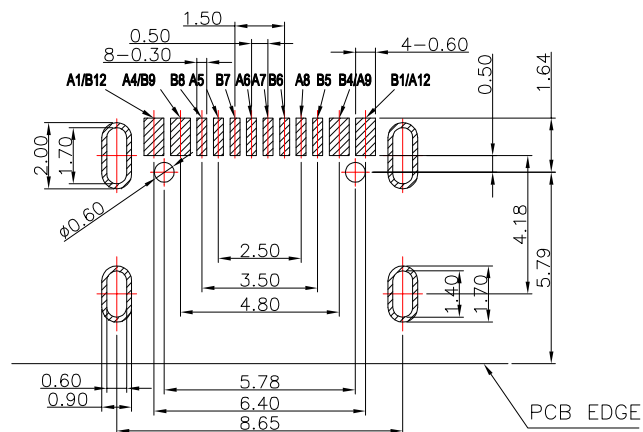

RECOMMEND P.C.B LAYOUT (COMPONENT SIDE)  
TOLERANCE FOR PCB LAYOUT IS ± 0.05

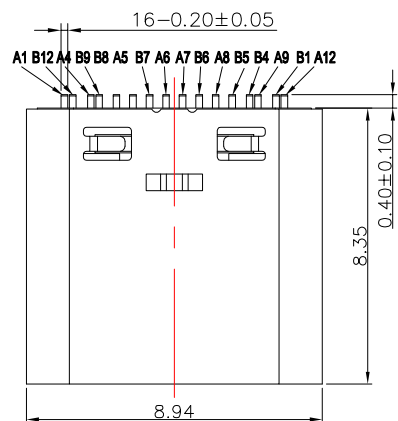
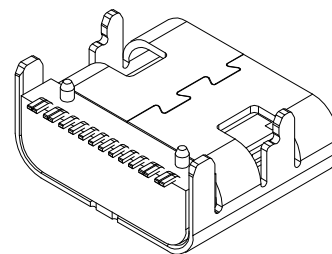
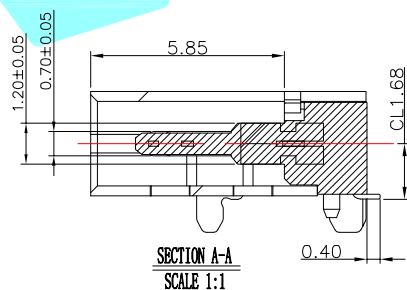
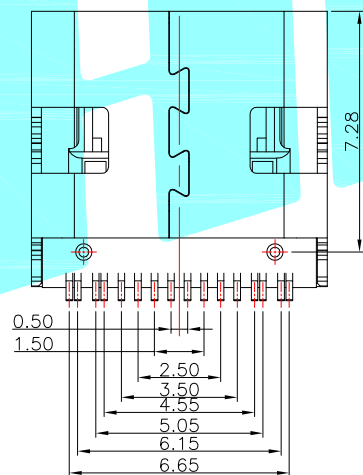
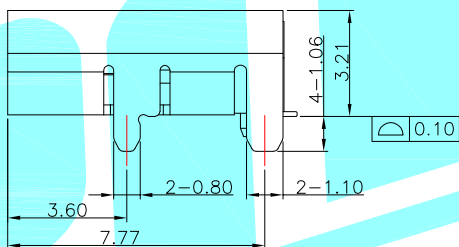
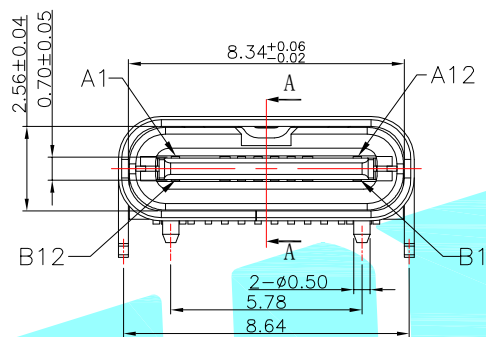

A1	GND	B12	GND
A4	VBUS	B9	VBUS
A5	CC1	B8	SBU2
A6	DP1	B7	DN2
A7	DN1	B6	DP2
A8	SBU1	B5	CC2
A9	VBUS	B4	VBUS
A12	GND	B1	GND
PIN	SIGNAL NAME	PIN	SIGNAL NAME

NOTE:

- MATERIAL SPECIFICATION:
  - HOUSING: LCP.
  - CONTACTS: COPPER ALLOY
  - MID PLATE: STAINLESS STEEL
- PLATING SPECIFICATION:
  - CONTACTS:
    - Ni 50u" MIN. UNDER PLATED OVER ALL.
    - Au PLATED ON THE FUNCTIONAL AREA OF CONTACT. (GOLD PLATING THICKNESS FOLLOW THE P/N)
    - GOLD FLASH PLATING ON SOLDER AREA
  - FRONT SHELL:
    - Ni 30u" MIN. UNDER PLATED OVER ALL.
- MECHANICAL PERFORMANCE,
  - INSERTION FORCE: 0.5~2.0kgf.
  - REMOVAL FORCE: 0.8kgf~2.0kgf.
  - DURABILITY: 10000 CYCLES.
- ELECTRICAL PERFORMANCE,
  - CURRENT RATING: 5A  
VOLTAGE RATING: 20V
  - INSULATION RESISTANCE: 100MΩ MIN
  - DIELECTRIC WITHSTAND VOLTAGE, AC 100V FOR 1 MINUTE.
  - LOW CONTACT RESISTANCE: INITIAL 40MΩ  
AFTER 50MΩ
- ENVIRONMENTAL PERFORMANCE:
  - OPERATING TEMPERATURE: -30°C~+80°C.
- IR REFLOW:
  - THE PEAK TEMPERATURE ON THE BOARD SHALL BE MAINTAINED FOR 10 SECONDS AT 260°C.

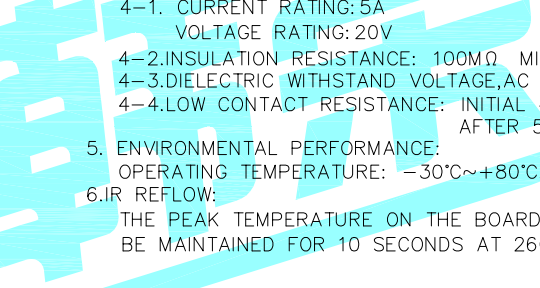

APPROVALS		DATE		 ELECTRONICS CO.,LTD		
DRAWN	LIUCAN	2022.12.24				
CHECKED				PART NO.	TYPE-C-31-M-38	
APPROVALS				UNIT: mm	SCALE: 1:1	PROJ:
TOLERANCES ARE		30~以上	±0.30	ANGLE	DRAWING NO.	SHEET 1 OF 1
		10~30	±0.20			
		5~10	±0.15			
		~ 5	±0.10	±2'		

ECN NO.	REV.	DATE.	DESCRIPTION.	CHANGE.	CHECK.	APPRO.
	A		NEW			

## X-ON Electronics

Largest Supplier of Electrical and Electronic Components

*Click to view similar products for [USB Connectors](#) category:*

*Click to view products by [HRO parts manufacturer](#):*

Other Similar products are found below :

[950](#) [A-USB A-LP-SMT-C](#) [A-USB B-TOP-C](#) [MUSBD11135](#) [17-200721](#) [217450-1](#) [KMBVX-TH-5S-B30](#) [KUSBX-AS2N-W](#) [KUSBX-SMT2AP1S-W30](#) [935](#) [957](#) [30-498-6](#) [SK-60A-2](#) [1734082-1](#) [30-470](#) [30-489](#) [30-541](#) [MAB 5 S](#) [A-USB A-2P-C](#) [MIKROE-1451](#)  
[USBFTVSCCG](#) [1-1734084-2](#) [MUSBA81130](#) [NK-27-32SL](#) [NK-L8-22C-5/8](#) [10135326-001LF](#) [4198](#) [690-024-633-031](#) [UB-20PMFP-LC7001](#)  
[17-200011](#) [UB-20AFMM-LL7A01](#) [CAP-WCCMLPB1](#) [CAP-WCCMLPC1](#) [2274475-3](#) [914-614A2025S10200](#) [USB3FTV7SAGF059](#)  
[USB3FTV2SAZNF459](#) [USB3FTV7SAZNF459](#) [HYCW153-USBD05-500B](#) [HYCW219-USBD05-075B](#) [HYCW148-USBD05-117B](#)  
[HYCW149-USBD05-740B](#) [HYCW204-USBD05-108B](#) [HYCW214-USBA04-113B](#) [HYCW213-USBA04-113B](#) [KMMX-BSMT35S-1-B30TR](#)  
[2345986-1](#) [10082141-N340LF](#) [10117836-011LF](#) [GSB3C3133DSYHR](#)