

## FEATURES

- High Current Capability 1.5A
- Low Dropout Voltage 350mV
- Low Ground Current
- Accurate 1% Guaranteed Initial Tolerance
- Extremely Fast Transient Response
- Reverse-Battery and "Load Dump" Protection
- Zero-Current Shutdown Mode(5-Pin Version)
- Error Flag Signals Output out-of-Regulation (5-Pin Version)
- Also Characterized For Smaller Loads With Industry -Leading Performance specifications
- Fixed Voltage and Adjustable Versions
- Moisture Sensitivity Level 3

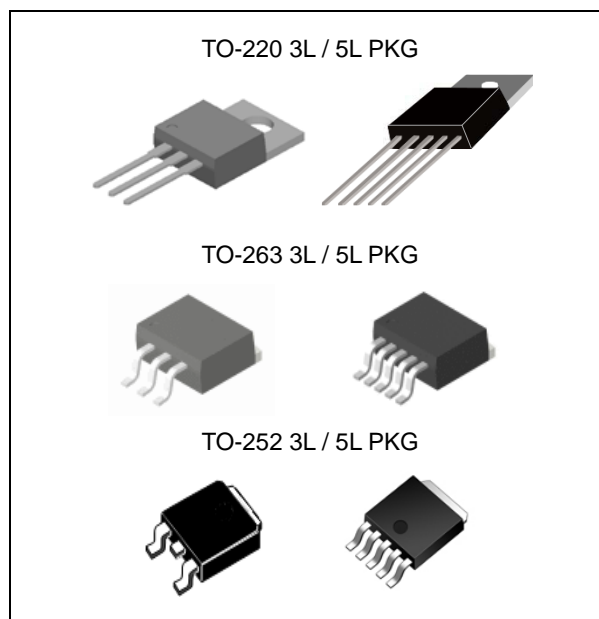

## APPLICATION

- Battery Powered Equipment
- High-Efficiency " Green" Computer System
- Automotive Electronics
- High-Efficiency Linear Power Supplies
- High-Efficiency Post-Regulator For Switching Supply

## DESCRIPTION

The LM29150, LM29151 and LM29152 are high current, high accuracy, and low-dropout voltage regulators. Using process with a PNP pass element, these regulators feature 350mV (full load) dropout voltages and very low ground current. These devices also find applications in lower current, low dropout-critical systems, where their tiny dropout voltage and ground current values are important attributes.

The LM29150, LM29151 and LM29152 are fully protected against over current faults, reversed input polarity, reversed lead insertion, over temperature operation, and positive and negative transient voltage spikes. LM29151 features logic level enable control and an error flag which signals whenever the output falls out of regulation. On the LM29151 and LM29152, the ENABLE pin may be tied to  $V_{in}$  if it is not required for ON/OFF control.

## ORDERING INFORMATION

| Device        | Package        |
|---------------|----------------|
| LM29150T-X.X  | TO-220 3L / 5L |
| LM29151T-X.X  |                |
| LM29152T      |                |
| LM29150R-X.X  | TO-263 3L / 5L |
| LM29151R-X.X  |                |
| LM29152R      |                |
| LM29150RS-X.X | TO-252 3L / 5L |
| LM29151RS-X.X |                |
| LM29152RS     |                |
| LM29152GRS    |                |

X.X = Output Voltage = 1.5, 1.8, 2.5, 3.0, 3.3, 5.0, 12

## Absolute Maximum Ratings

| CHARACTERISTIC                           | SYMBOL    | MIN. | MAX.  | UNIT |
|--|-----------|------|-------|------|
| Input Supply Voltage <sup>(Note 1)</sup> | $V_{IN}$  | - 20 | + 60  | V    |
| Enable Input Voltage <sup>(Note 1)</sup> | $V_{EN}$  | - 20 | + 60  | V    |
| Lead Temperature(Soldering, 5 sec)       | $T_{SOL}$ | -    | 260   | °C   |
| Storage Temperature Range                | $T_{STG}$ | - 65 | + 150 | °C   |

**Recommended Operating Ratings** (Note 2)

| CHARACTERISTIC                 | SYMBOL   | MIN. | MAX.  | UNIT |
|--------------------------------|----------|------|-------|------|
| Operating Input Voltage        | $V_{IN}$ | -    | + 26  | V    |
| Operating Enable Input Voltage | $V_{EN}$ | -    | + 26  | V    |
| Junction Temperature           | $T_J$    | - 40 | + 125 | °C   |

**Ordering Information**

| $V_{OUT}$ | Package   | Order No.     | Description         | Supplied As | Status |
|-----------|-----------|---------------|---------------------|-------------|--------|
| 1.5 V     | TO-220 3L | LM29150T-1.5  | 1.5A, Fixed         | Tube        | Active |
|           | TO-220 5L | LM29151T-1.5  | 1.5A, Fixed, Enable | Tube        | Active |
|           | TO-263 3L | LM29150R-1.5  | 1.5A, Fixed         | Reel        | Active |
|           | TO-263 5L | LM29151R-1.5  | 1.5A, Fixed, Enable | Reel        | Active |
|           | TO-252 3L | LM29150RS-1.5 | 1.5A, Fixed         | Reel        | Active |
|           | TO-252 5L | LM29151RS-1.5 | 1.5A, Fixed, Enable | Reel        | Active |
| 1.8 V     | TO-220 3L | LM29150T-1.8  | 1.5A, Fixed         | Tube        | Active |
|           | TO-220 5L | LM29151T-1.8  | 1.5A, Fixed, Enable | Tube        | Active |
|           | TO-263 3L | LM29150R-1.8  | 1.5A, Fixed         | Reel        | Active |
|           | TO-263 5L | LM29151R-1.8  | 1.5A, Fixed, Enable | Reel        | Active |
|           | TO-252 3L | LM29150RS-1.8 | 1.5A, Fixed         | Reel        | Active |
|           | TO-252 5L | LM29151RS-1.8 | 1.5A, Fixed, Enable | Reel        | Active |
| 2.5 V     | TO-220 3L | LM29150T-2.5  | 1.5A, Fixed         | Tube        | Active |
|           | TO-220 5L | LM29151T-2.5  | 1.5A, Fixed, Enable | Tube        | Active |
|           | TO-263 3L | LM29150R-2.5  | 1.5A, Fixed         | Reel        | Active |
|           | TO-263 5L | LM29151R-2.5  | 1.5A, Fixed, Enable | Reel        | Active |
|           | TO-252 3L | LM29150RS-2.5 | 1.5A, Fixed         | Reel        | Active |
|           | TO-252 5L | LM29151RS-2.5 | 1.5A, Fixed, Enable | Reel        | Active |
| 3.0 V     | TO-220 3L | LM29150T-3.0  | 1.5A, Fixed         | Tube        | Active |
|           | TO-220 5L | LM29151T-3.0  | 1.5A, Fixed, Enable | Tube        | Active |
|           | TO-263 3L | LM29150R-3.0  | 1.5A, Fixed         | Reel        | Active |
|           | TO-263 5L | LM29151R-3.0  | 1.5A, Fixed, Enable | Reel        | Active |
|           | TO-252 3L | LM29150RS-3.0 | 1.5A, Fixed         | Reel        | Active |
|           | TO-252 5L | LM29151RS-3.0 | 1.5A, Fixed, Enable | Reel        | Active |
| 3.3 V     | TO-220 3L | LM29150T-3.3  | 1.5A, Fixed         | Tube        | Active |
|           | TO-220 5L | LM29151T-3.3  | 1.5A, Fixed, Enable | Tube        | Active |
|           | TO-263 3L | LM29150R-3.3  | 1.5A, Fixed         | Reel        | Active |
|           | TO-263 5L | LM29151R-3.3  | 1.5A, Fixed, Enable | Reel        | Active |
|           | TO-252 3L | LM29150RS-3.3 | 1.5A, Fixed         | Reel        | Active |
|           | TO-252 5L | LM29151RS-3.3 | 1.5A, Fixed, Enable | Reel        | Active |

Ordering Information

| V <sub>OUT</sub> | Package   | Order No.     | Description              | Supplied As | Status |
|------------------|-----------|---------------|--------------------------|-------------|--------|
| 5.0 V            | TO-220 3L | LM29150T-5.0  | 1.5A, Fixed              | Tube        | Active |
|                  | TO-220 5L | LM29151T-5.0  | 1.5A, Fixed, Enable      | Tube        | Active |
|                  | TO-263 3L | LM29150R-5.0  | 1.5A, Fixed              | Reel        | Active |
|                  | TO-263 5L | LM29151R-5.0  | 1.5A, Fixed, Enable      | Reel        | Active |
|                  | TO-252 3L | LM29150RS-5.0 | 1.5A, Fixed              | Reel        | Active |
|                  | TO-252 5L | LM29151RS-5.0 | 1.5A, Fixed, Enable      | Reel        | Active |
| 12 V             | TO-220 3L | LM29150T-12   | 1.5A, Fixed              | Tube        | Active |
|                  | TO-220 5L | LM29151T-12   | 1.5A, Fixed, Enable      | Tube        | Active |
|                  | TO-263 3L | LM29150R-12   | 1.5A, Fixed              | Reel        | Active |
|                  | TO-263 5L | LM29151R-12   | 1.5A, Fixed, Enable      | Reel        | Active |
|                  | TO-252 3L | LM29150RS-12  | 1.5A, Fixed              | Reel        | Active |
|                  | TO-252 5L | LM29151RS-12  | 1.5A, Fixed, Enable      | Reel        | Active |
| ADJ              | TO-220 5L | LM29152T      | 1.5A, Adjustable, Enable | Tube        | Active |
|                  | TO-263 5L | LM29152R      | 1.5A, Adjustable, Enable | Reel        | Active |
|                  | TO-252 5L | LM29152RS     | 1.5A, Adjustable, Enable | Reel        | Active |
|                  | TO-252 5L | LM29152GRS    | 1.5A, Adjustable, Enable | Reel        | Active |

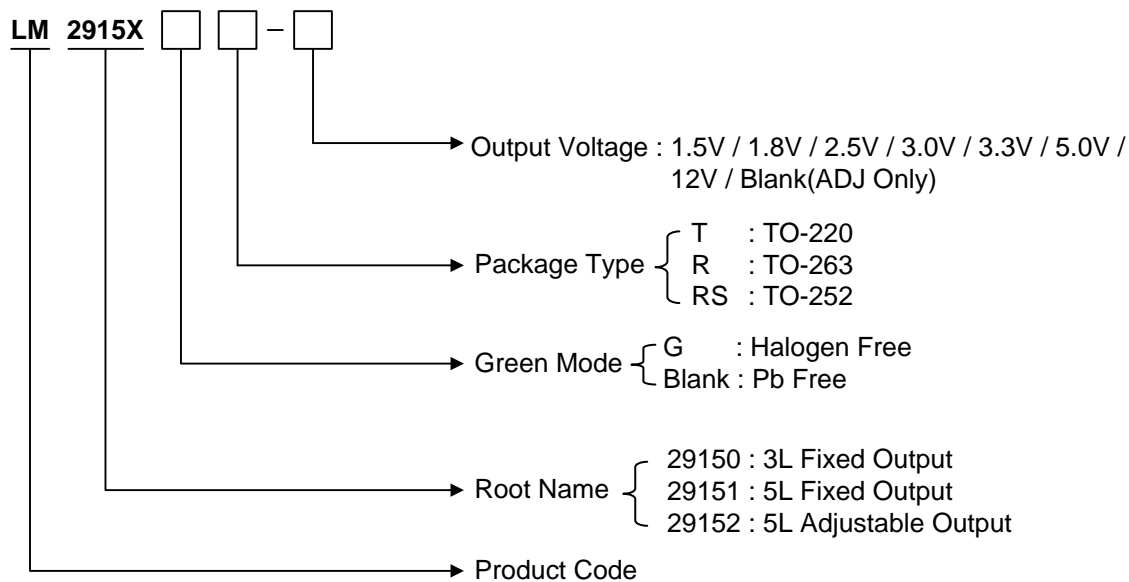

**PIN CONFIGURATION**

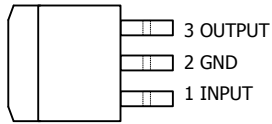

TO-263 3L

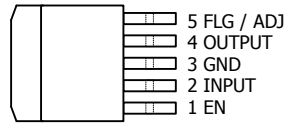

TO-263 5L

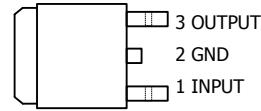

TO-252 3L

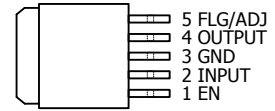

TO-252 5L

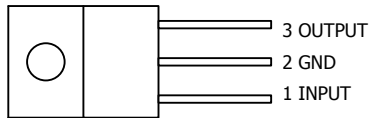

TO-220 3L

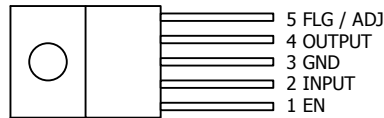

TO-220 5L

**PIN DESCRIPTION**

| Pin No. | TO-220 / TO-263 / TO-252 3L (for LM29150) |                | TO-220 / TO-263 / TO-252 5L (for LM29151/2) |                                    |
|---------|---|----------------|---|------------------------------------|
|         | Name                                      | Function       | Name  | Function                           |
| 1       | V <sub>IN</sub>                           | Input Supply   | EN  | Chip Enable                        |
| 2       | GND                                       | Ground         | V <sub>IN</sub>                             | Input Supply                       |
| 3       | V <sub>OUT</sub>                          | Output Voltage | GND   | Ground                             |
| 4       | -   | -              | V <sub>OUT</sub>                            | Output Voltage                     |
| 5       | -   | -              | FLG / ADJ                                   | Error Flag Output or Output Adjust |

**TYPICAL APPLICATION**

– Typical Fixed Output Application

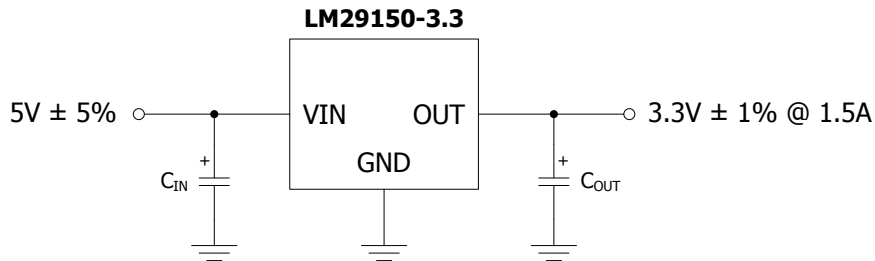

– Typical Fixed Output Application with Error Flag

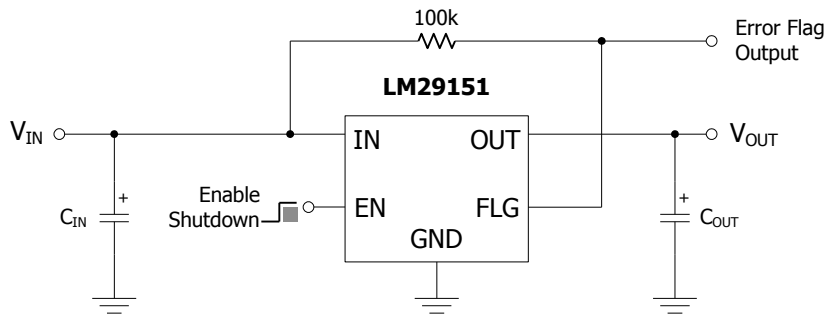

– Typical Adjustable Output Application

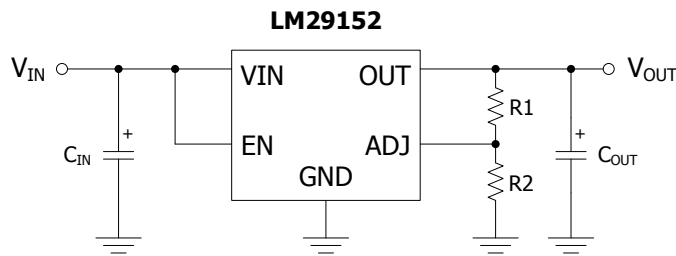

$$V_{OUT} = V_{REF} \times [1 + (R1/R2)] *$$

\* For best results, the total series resistance should be small enough to pass the minimum regulator load current.

**ELECTRICAL CHARACTERISTICS**

$I_{OUT}=100\text{mA}$ ,  $T_J=25^\circ\text{C}$ , unless otherwise specified. **Bold** values are guaranteed across the operating temperature range. Adjustable versions are programmed to 5.0V.

**LM29150/29151/29152 Common Specification**

| Symbol                | Parameter  | Condition  | Min        | Typ       | Max        | Units                 |
|-----------------------|--|--|------------|-----------|------------|-----------------------|
| $V_{OUT}$             | Output Voltage   | $I_O = 10\text{mA}$  | -1         |           | 1          | %                     |
|                       |  | $10\text{mA} \leq I_O \leq I_{FL}$ ,<br>$(V_{OUT}+1\text{V}) \leq V_{IN} \leq 26\text{V}$ (Note 2) | <b>-2</b>  |           | <b>2</b>   |                       |
| $\Delta V_{LINE}$     | Line Regulation  | $I_O = 10\text{mA}$ , $(V_{OUT}+1\text{V}) \leq V_{IN} \leq 26\text{V}$                            |            | 0.06      | 0.5        | %                     |
| $\Delta V_{LOAD}$     | Load Regulation  | $V_{IN}=V_{OUT}+5\text{V}$ ,<br>$10\text{mA} \leq I_{OUT} \leq I_{FULLLOAD}$ (Note 2,6)            |            | 0.2       | 1          | %                     |
| $\Delta V_O/\Delta T$ | Output Voltage Temp. Coefficient                                 | Output Voltage (Note 6),<br>Temp. Coefficient  |            | <b>20</b> | <b>100</b> | ppm/ $^\circ\text{C}$ |
| $V_{DO}$              | Dropout Voltage  | $\Delta V_{OUT} = -1\%$ , (Note 3)   |            |           |            |                       |
|                       |  | $I_O = 100\text{mA}$   |            | 80        | <b>200</b> | mV                    |
|                       |  | $I_O = 750\text{mA}$   |            | 220       |            |                       |
| $I_O = 1.5\text{A}$   |  | 350  | <b>600</b> |           |            |                       |
| $I_{GND}$             | Ground Current   | $I_O = 750\text{mA}$ , $V_{IN} = V_{OUT} + 1\text{V}$  |            | 8         | <b>20</b>  | mA                    |
|                       |  | $I_O = 1.5\text{A}$  |            | 22        |            |                       |
| $I_{GNDDO}$           | Ground Pin Current at Dropout                                    | $V_{IN} = 0.5\text{V}$ less than specified $V_{OUT}$ ,<br>$I_{OUT} = 10\text{mA}$                  |            | 2         |            | mA                    |
| $I_{LIMIT}$           | Current Limit  | LM29150, $V_{OUT} = 0\text{V}$ (Note 4)  |            | 2.1       | <b>3.5</b> | A                     |
| $e_n$                 | Output Noise Voltage<br>(10Hz to 100kHz)<br>$I_L = 100\text{mA}$ | $C_L = 10\mu\text{F}$  |            | 400       |            | $\mu\text{VRMS}$      |
|                       |  | $C_L = 33\mu\text{F}$  |            | 260       |            |                       |

**Flag Output (Error Comparator) LM29151**

|                        |                         |  |                 |      |                     |               |
|------------------------|-------------------------|--|-----------------|------|---------------------|---------------|
| $I_{FLG}(\text{leak})$ | Output Leakage Current  | $V_{OH} = 26\text{V}$  |                 | 0.01 | 1.00<br><b>2.00</b> | $\mu\text{A}$ |
| $V_{FLG}(\text{do})$   | Output Low Voltage      | Device set for 5V. $V_{IN} = 4.5\text{V}$<br>$I_{OL} = 250\mu\text{A}$ |                 | 220  | 300<br><b>400</b>   | mV            |
| $V_{FLG}$              | Upper Threshold Voltage | Device set for 5V (Note 9)   | 40<br><b>25</b> | 60   |                     | mV            |
|                        | Lower Threshold Voltage | Device set for 5V (Note 9)   |                 | 75   | 95<br><b>140</b>    | mV            |
|                        | Hysteresis              | Device set for 5V (Note 9)   |                 | 15   |                     | mV            |

## Reference LM29152

|                  |   |          |                       |      |                       |        |
|------------------|---|----------|-----------------------|------|-----------------------|--------|
| V <sub>REF</sub> | Reference Voltage                         |          | 1.228<br><b>1.215</b> | 1.24 | 1.252<br><b>1.265</b> | V      |
|                  |   | (Note 8) | 1.203                 |      | 1.277                 | V      |
| I <sub>ADJ</sub> | Adjust Pin Bias Current                   |          |                       | 40   | 80<br>120             | nA     |
|                  | Reference Voltage Temp. Coefficient       | (Note 7) |                       | 20   |                       | ppm/°C |
|                  | Adjust Pin Bias Current Temp. Coefficient |          |                       | 0.1  |                       | nA/°C  |

## Enable Input LM29151 / LM29152

|                 |                                      |                                    |            |     |                 |    |
|-----------------|--------------------------------------|------------------------------------|------------|-----|-----------------|----|
| V <sub>EN</sub> | Enable Input Voltage                 | Logic Low (Off)<br>Logic High (On) | <b>2.4</b> |     | <b>0.8</b>      | V  |
| I <sub>EN</sub> | Enable Pin Input Current             | V <sub>EN</sub> = 26V              |            | 100 | 600<br>750      | μA |
|                 |                                      | V <sub>EN</sub> = 0.8V             |            |     | 2.5<br><b>5</b> | μA |
|                 | Regulator Output Current in Shutdown | (Note 10)                          |            | 10  | <b>500</b>      | μA |

Note 1. Maximum positive supply voltage of 60V must be of limited duration (<100msec) and duty cycle(≤1%). The maximum continuous supply voltage is 26V.

Note 2. Full load current (I<sub>FL</sub>) is defined as 1.5A.

Note 3. Dropout voltage is defined as the input-to-output differential when the output voltage drops to 99% of its nominal value with V<sub>OUT</sub> to V<sub>IN</sub>.

Note 4. V<sub>IN</sub> = V<sub>OUT</sub>(nominal) + 1V. For example, use V<sub>IN</sub> = 4.3V for a 3.3V regulator or use 6V for a 5V regulator. Employ pulse-testing procedures to minimize temperature rise.

Note 5. Ground pin current is the regulator quiescent current. The total current drawn from the source is the sum of the load current plus the ground pin current.

Note 6. Output voltage temperature coefficient is defined as the worst case voltage change divided by the total temperature range.

Note 7. Thermal regulation is defined as the change in output voltage at a time T after a change in power dissipation is applied, excluding load or line regulation effects. Specifications are for a 200mA load pulse at V<sub>IN</sub> = 20V (a 4W pulse) for T = 10ms.

Note 8. V<sub>REF</sub> ≤ V<sub>OUT</sub> ≤ (V<sub>IN</sub> - 1V), 2.3V ≤ V<sub>IN</sub> ≤ 26V, 10mA < I<sub>L</sub> < I<sub>FL</sub>, T<sub>J</sub> < T<sub>J</sub> Max.

Note 9. Comparator thresholds are expressed in terms of a voltage differential at the Adjust terminal below the nominal reference voltage measured at 6V input. To express these thresholds in terms of output voltage change, multiply by the error amplifier gain = V<sub>OUT</sub> / V<sub>REF</sub> = (R1 + R2) / R2. For example, at a programmed output voltage of 5V, the Error output is guaranteed to go low when the output drops by 95mV × 5V / 1.240V = 384mV. Thresholds remain constant as a percent of V<sub>OUT</sub> as V<sub>OUT</sub> is varied, with the dropout warning occurring at typically 5% below nominal, 7.7% guaranteed.

Note 10. V<sub>EN</sub> ≤ 0.8V and V<sub>IN</sub> ≤ 26V, V<sub>OUT</sub> = 0.

Note 11. When used in dual supply system where the regulator load is returned to a negative supply, the output voltage must be diode clamped to ground.

TYPICAL OPERATING CHARACTERISTICS

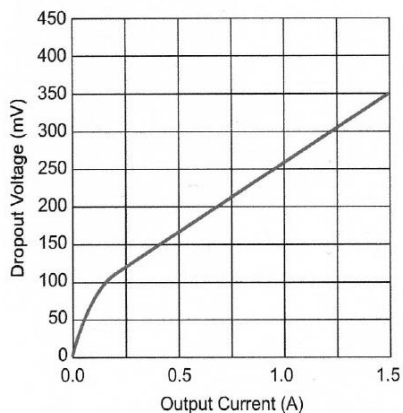

LM29150 Dropout Voltage vs, Output

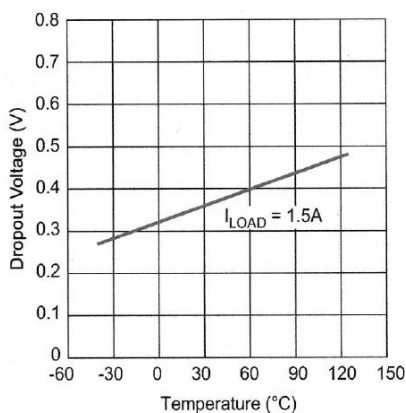

LM29150 Dropout Voltage vs, Temperature

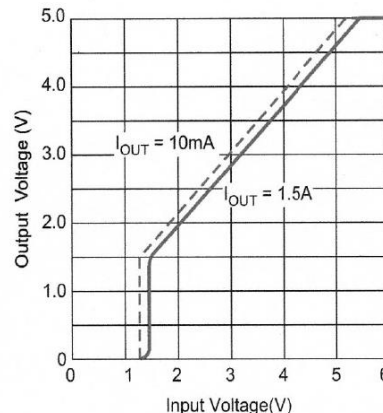

LM29150-5.0 Dropout Characteristics

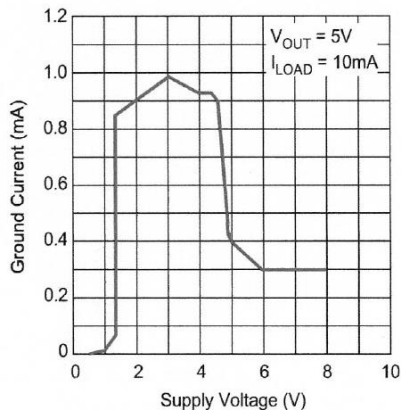

LM29150 Ground Current vs, Supply Voltage

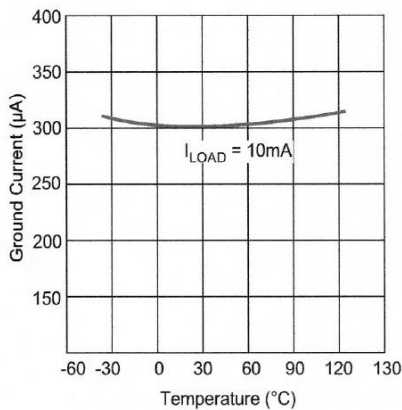

LM29150 Ground Current vs, Temperature

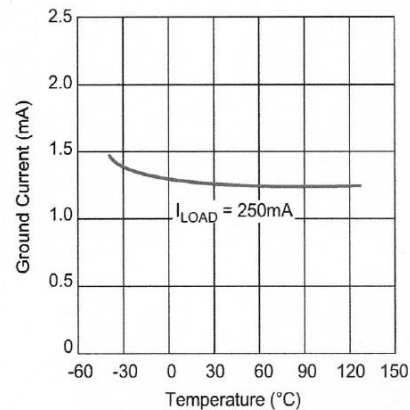

LM29150 Ground Current vs, Temperature

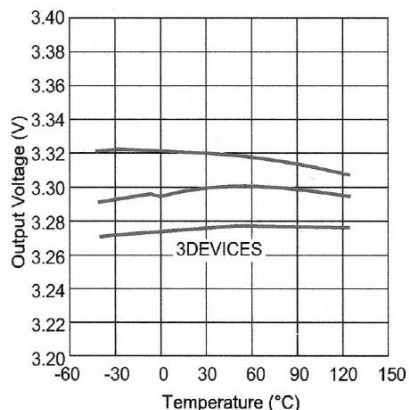

LM29150-3.3 Output Voltage vs. Temperature

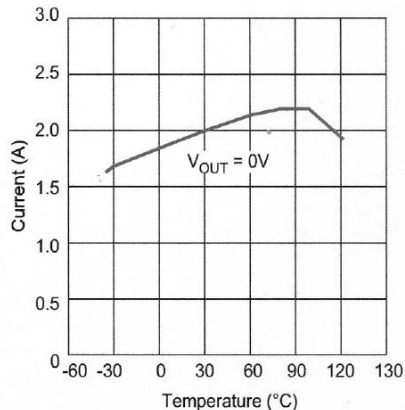

LM29150-3.3 Short Circuit Current vs. Temperature

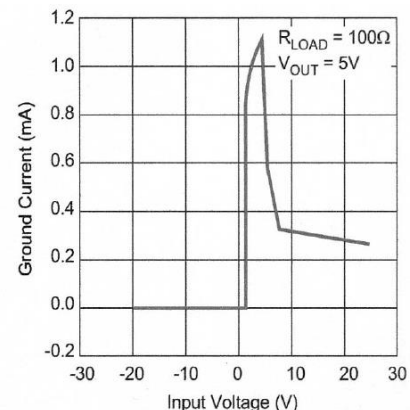

LM29150 Ground Current vs. Input Voltage



## APPLICATION INFORMATION

The LM29150 are high performance low-dropout voltage regulators suitable for all moderate to high current voltage regulator applications. Their 350mV dropout voltage at full load makes them especially valuable in battery powered systems and as high efficiency noise filters in "post-regulator" applications. Unlike older NPN-pass transistor designs, dropout performance of the PNP output of these devices is limited merely by the low  $V_{CE}$  saturation voltage.

The LM29150 family of regulators is fully protected from damage due to fault conditions. Current Limiting is provided. This limiting is linear; output current under overload conditions is constant. Thermal shutdown disables the device when the die temperature exceeds the 125°C maximum safe operating temperature. Transient protection allows device survival even when the input voltage spikes between -20V and +60V. When the input voltage exceeds about 35V to 40V, the over voltage sensor temporarily disables the regulator.

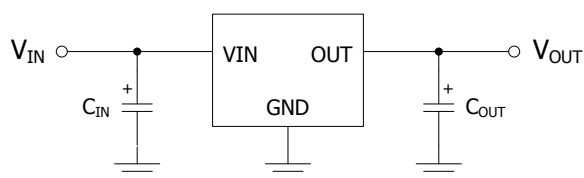

Figure 1. Linear regulators require only two capacitors for operation.

### Thermal Design

Linear regulators are simple to use. The most complicated design parameters to consider are thermal characteristics. Thermal design requires the following application-specific parameters:

- Maximum ambient temperature,  $T_A$
- Output Current,  $I_{OUT}$
- Output Voltage,  $V_{OUT}$
- Input Voltage,  $V_{IN}$

First, we calculate the power dissipation of the regulator from these numbers and the device parameters from this datasheet.

$$P_D = I_{OUT}(1.01V_{IN} - V_{OUT})$$

Where the ground current is approximated by 1% of  $I_{OUT}$ . Then the heat sink thermal resistance is determined with this formula:

$$\theta_{SA} = \frac{T_{JMAX} - T_A}{P_D} - (\theta_{JC} + \theta_{CS})$$

Where  $T_{JMAX} \leq 125^\circ\text{C}$  and  $\theta_{CS}$  is between 0 and 2°C/W.

### Capacitor Requirements

For stability and minimum output noise, a capacitor on the regulator output is necessary. The value of this capacitor is dependent upon the output current; lower currents allow smaller capacitors. LM29150 regulators are stable with the 10uF minimum capacitor values at full load. Where the regulator is powered from a source with a high AC impedance, a 0.1uF capacitor connected between input and GND is recommended. This capacitor should have good characteristics to above 250kHz.

### Minimum Load Current

The LM29150 regulators are specified between finite loads. If the output is too small, leakage currents is too small, leakage currents dominate and the output voltage rises. The 5mA minimum load current swamps any expected leakage current across the operating temperature range.

### Adjustable Regulator Design

The adjustable regulator versions, LM29152 allows programming the output voltage anywhere between 1.25V and the 25V maximum operating rating of the family.

Two resistors are used. Resistors can be quite large, up to 1M $\Omega$ , because of the very high input impedance and low bias current of the sense comparator: The resistor values are calculated by:

$$R1=R2\left(\frac{V_{OUT}}{V_{REF}} - 1\right)$$

Where  $V_{OUT}$  is desired output voltage, Figure 2 shows component definition. Applications with widely varying load currents may scale the resistors to draw the minimum load current required for proper operation.

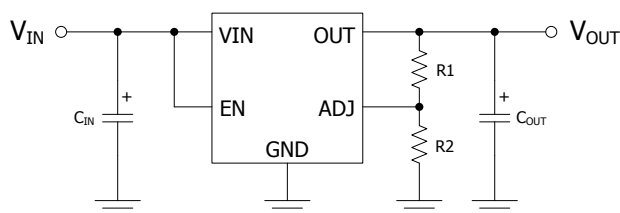

$$V_{OUT} = 1.240 \times [1 + (R1/R2)]$$

Figure 2. Adjustable Regulator with Resistors

### Error Flag

LM29151 versions feature an Error Flag, which looks at the output voltage and signals an error condition when this voltage drops 5% below its expected value. The error flag is an open-collector output that pulls low under fault conditions. It may sink 10mA. Low output voltage signifies a number of possible problems, including an over-current fault (the device is in current limit) and low input voltage. The flag output is inoperative during over temperature shutdown conditions.

## Enable input

LM29151 and LM29152 versions feature an enable (EN) input that allows ON/OFF control of the device. Special design allows "zero" current drain when the device is disabled—only microamperes of leakage current flows. The EN input has TTL/CMOS compatible thresholds for simple interfacing with logic, or may be directly tied to  $\leq 30V$ . Enabling the regulator requires approximately 20uA of current.

**REVISION NOTICE**

The description in this datasheet can be revised without any notice to describe its electrical characteristics properly.

## X-ON Electronics

Largest Supplier of Electrical and Electronic Components

*Click to view similar products for [Linear Voltage Regulators](#) category:*

*Click to view products by [HTC Korea](#) manufacturer:*

Other Similar products are found below :

[LV5684PVD-XH](#) [MCDTSA6-2R](#) [L7815ACV-DG](#) [714954EB](#) [ZMR500QFTA](#) [BA033LBSG2-TR](#) [LV5680P-E](#) [L79M05T-E](#) [L78LR05D-MA-E](#) [NCV317MBTG](#) [NTE7227](#) [MP2018GZD-33-P](#) [MP2018GZD-5-P](#) [LV5680NPVC-XH](#) [LT1054CN8](#) [ZTS6538SE](#) [UA78L09CLP](#) [UA78L09CLPR](#) [CAT6221-PPTD-GT3](#) [MC78M09CDTRK](#) [NCV51190MNTAG](#) [78M05](#) [HT7150-1](#) [UM1540DB-18](#) [XC6234H281VR-G](#) [WL2834CA-6/TR](#) [TPL730F33-5TR](#) [TLS850F1TA](#) [V50](#) [TPS549B22RVFR](#) [UM1540DB-33](#) [WL9200P3-50B](#) [WL9100P3-33B](#) [WL9005D4-33](#) [XC6219B152MR](#) [WL2855K33-3/TR](#) [PJ54BM33SE](#) [PJ9500M25SA](#) [MD7218E33PC1](#) [H7533-2PR](#) [SK7812AU](#) [SD1A30](#) [78L33](#) [TP78L33T3](#) [L78L33ACUTR](#) [SK6513ST3A-50](#) [SK6054D4-09](#) [SK6054D4-18](#) [SK6054D4-11](#) [SK6054D4-10](#) [LM79L12F](#)