

1.0 A Low-Dropout Positive Fixed and Adjustable Voltage Regulators

The HT1117A series of positive adjustable and fixed regulators is designed to provide 1A with high efficiency. All the internal circuitry is designed to operate down to 1.4V input-to-output differential. On-chip trimming adjusts the reference voltage to 1%. The typical current limit value of 1.5A allows the stress on both the regulator and the power source circuitry to be minimized under overload conditions.

Features

- Output Current in Excess of 1.0 A
- 1.2 V Maximum Dropout Voltage at 800 mA Over Temperature
- Fixed Output Voltages of 1.5 V, 1.8 V, 1.9 V, 2.0 V, 2.5 V, 2.85 V, 3.3 V, 5.0 V, and 12 V
- Adjustable Output Voltage Option
- No Minimum Load Requirement for Fixed Voltage Output Devices
- Reference/Output Voltage Trimmed to $\pm 1.0\%$
- Current Limit, Safe Operating and Thermal Shutdown Protection
- Operation to 20 V Input
- These are Pb-Free Devices

Applications

- Consumer and Industrial Equipment Point of Regulation
- Active SCSI Termination for 2.85 V Version
- Switching Power Supply Post Regulation
- Hard Drive Controllers
- Battery Chargers

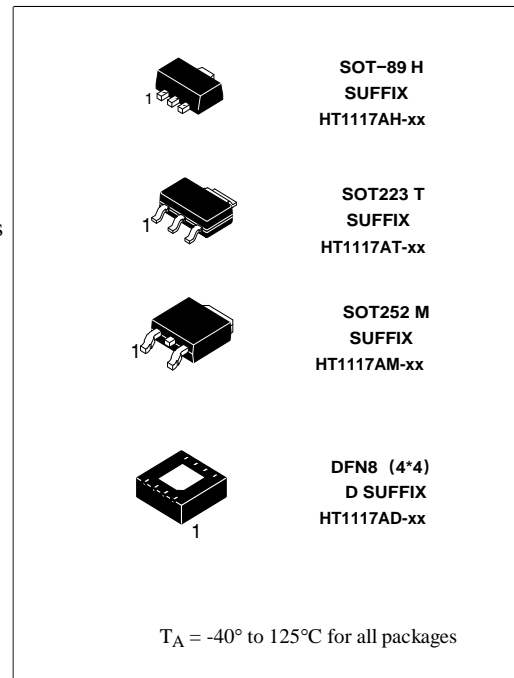

PIN CONFIGURATION

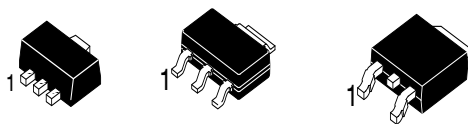

Pin: 1. Adjust/Ground
2. Output
3. Input

Heatsink tab is connected to Pin 2.

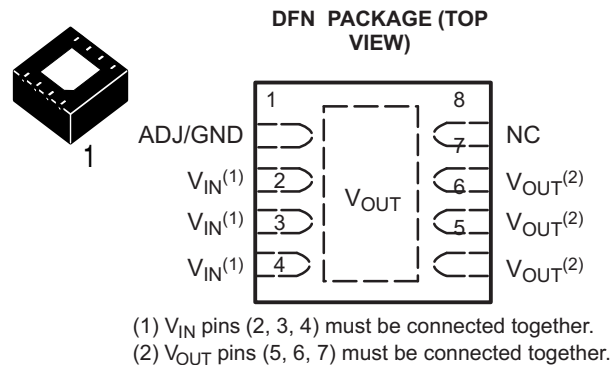

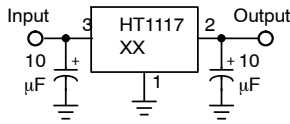
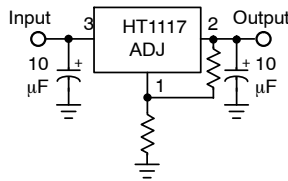
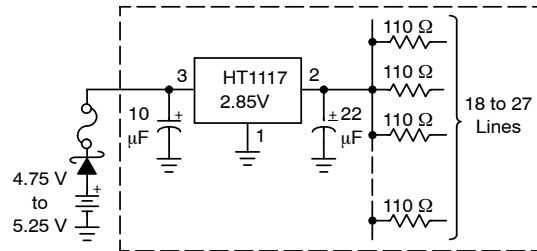
TYPICAL APPLICATIONS

Figure 1. Fixed Output Regulator

Figure 2. Adjustable Output Regulator

Figure 3. Active SCSI Bus Terminator
MAXIMUM RATINGS

Rating	Symbol	Value	Unit
Input Voltage (Note 1)	V_{in}	20	V
Output Short Circuit Duration (Notes 2 and 3)	-	Infinite	-
Power Dissipation and Thermal Characteristics			
Case 318H (SOT-223)			
Power Dissipation (Note 2)	P_D	Internally Limited	W
Thermal Resistance, Junction-to-Ambient, Minimum Size Pad	$R_{\theta JA}$	160	$^{\circ}C/W$
Thermal Resistance, Junction-to-Case	$R_{\theta JC}$	15	$^{\circ}C/W$
Case 369A (DPAK)			
Power Dissipation (Note 2)	P_D	Internally Limited	W
Thermal Resistance, Junction-to-Ambient, Minimum Size Pad	$R_{\theta JA}$	67	$^{\circ}C/W$
Thermal Resistance, Junction-to-Case	$R_{\theta JC}$	6.0	$^{\circ}C/W$
Maximum Die Junction Temperature Range	T_J	-55 to 150	$^{\circ}C$
Storage Temperature Range	T_{stg}	-65 to 150	$^{\circ}C$
Operating Ambient Temperature Range	T_A	-40 to +125	$^{\circ}C$

Stresses exceeding Maximum Ratings may damage the device. Maximum Ratings are stress ratings only. Functional operation above the Recommended Operating Conditions is not implied. Extended exposure to stresses above the Recommended Operating Conditions may affect device reliability.

- This device series contains ESD protection and exceeds the following tests:
 Human Body Model (HBM), Class 2, 2000 V
 Machine Model (MM), Class B, 200 V
 Charge Device Model (CDM), Class IV, 2000 V.
- Internal thermal shutdown protection limits the die temperature to approximately 175 $^{\circ}C$. Proper heatsinking is required to prevent activation.
 The maximum package power dissipation is:

$$P_D = \frac{T_{J(max)} - T_A}{R_{\theta JA}}$$
- The regulator output current must not exceed 1.0 A with V_{in} greater than 12 V.

ELECTRICAL CHARACTERISTICS

($C_{in} = 10 \mu\text{F}$, $C_{out} = 10 \mu\text{F}$, for typical value $T_A = 25^\circ\text{C}$, for min and max values T_A is the operating ambient temperature range that applies unless otherwise noted.) (Note 4)

Characteristic	Symbol	Min	Typ	Max	Unit
Reference Voltage, Adjustable Output Devices ($V_{in}-V_{out} = 2.0 \text{ V}$, $I_{out} = 10 \text{ mA}$, $T_A = 25^\circ\text{C}$) ($V_{in}-V_{out} = 1.4 \text{ V}$ to 10 V , $I_{out} = 10 \text{ mA}$ to 800 mA) (Note 4)	V_{ref}	1.238 1.225	1.25 –	1.262 1.270	V
Output Voltage, Fixed Output Devices	V_{out}				V
1.5 V ($V_{in} = 3.5 \text{ V}$, $I_{out} = 10 \text{ mA}$, $T_A = 25^\circ\text{C}$) ($V_{in} = 2.9 \text{ V}$ to 11.5 V , $I_{out} = 0 \text{ mA}$ to 800 mA) (Note 4)		1.485 1.470	1.500 –	1.515 1.530	
1.8 V ($V_{in} = 3.8 \text{ V}$, $I_{out} = 10 \text{ mA}$, $T_A = 25^\circ\text{C}$) ($V_{in} = 3.2 \text{ V}$ to 11.8 V , $I_{out} = 0 \text{ mA}$ to 800 mA) (Note 4)		1.782 1.755	1.800 –	1.818 1.845	
1.9 V ($V_{in} = 3.9 \text{ V}$, $I_{out} = 10 \text{ mA}$, $T_A = 25^\circ\text{C}$) ($V_{in} = 3.3 \text{ V}$ to 11.9 V , $I_{out} = 0 \text{ mA}$ to 800 mA) (Note 4)		1.872 1.862	1.900 1.900	1.929 1.938	
2.0 V ($V_{in} = 4.0 \text{ V}$, $I_{out} = 10 \text{ mA}$, $T_A = 25^\circ\text{C}$) ($V_{in} = 3.4 \text{ V}$ to 12 V , $I_{out} = 0 \text{ mA}$ to 800 mA) (Note 4)		1.970 1.960	2.000 –	2.030 2.040	
2.5 V ($V_{in} = 4.5 \text{ V}$, $I_{out} = 10 \text{ mA}$, $T_A = 25^\circ\text{C}$) ($V_{in} = 3.9 \text{ V}$ to 10 V , $I_{out} = 0 \text{ mA}$ to 800 mA) (Note 4)		2.475 2.450	2.500 –	2.525 2.550	
2.85 V ($V_{in} = 4.85 \text{ V}$, $I_{out} = 10 \text{ mA}$, $T_A = 25^\circ\text{C}$) ($V_{in} = 4.25 \text{ V}$ to 10 V , $I_{out} = 0 \text{ mA}$ to 800 mA) (Note 4) ($V_{in} = 4.0 \text{ V}$, $I_{out} = 0 \text{ mA}$ to 500 mA) (Note 4)		2.821 2.790 2.790	2.850 – –	2.879 2.910 2.910	
3.3 V ($V_{in} = 5.3 \text{ V}$, $I_{out} = 10 \text{ mA}$, $T_A = 25^\circ\text{C}$) ($V_{in} = 4.75 \text{ V}$ to 10 V , $I_{out} = 0 \text{ mA}$ to 800 mA) (Note 4)		3.267 3.235	3.300 –	3.333 3.365	
5.0 V ($V_{in} = 7.0 \text{ V}$, $I_{out} = 10 \text{ mA}$, $T_A = 25^\circ\text{C}$) ($V_{in} = 6.5 \text{ V}$ to 12 V , $I_{out} = 0 \text{ mA}$ to 800 mA) (Note 4)		4.950 4.900	5.000 –	5.050 5.100	
12 V ($V_{in} = 14 \text{ V}$, $I_{out} = 10 \text{ mA}$, $T_A = 25^\circ\text{C}$) ($V_{in} = 13.5 \text{ V}$ to 20 V , $I_{out} = 0 \text{ mA}$ to 800 mA) (Note 4)		11.880 11.760	12.000 –	12.120 12.240	
Line Regulation (Note 5) Adjustable ($V_{in} = 2.75 \text{ V}$ to 16.25 V , $I_{out} = 10 \text{ mA}$)	Reg_{line}	–	0.04	0.1	%
1.5 V ($V_{in} = 2.9 \text{ V}$ to 11.5 V , $I_{out} = 0 \text{ mA}$)		–	0.3	1.0	mV
1.8 V ($V_{in} = 3.2 \text{ V}$ to 11.8 V , $I_{out} = 0 \text{ mA}$)		–	0.4	1.0	
1.9 V ($V_{in} = 3.3 \text{ V}$ to 11.9 V , $I_{out} = 0 \text{ mA}$)		–	0.5	2.5	
2.0 V ($V_{in} = 3.4 \text{ V}$ to 12 V , $I_{out} = 0 \text{ mA}$)		–	0.5	2.5	
2.5 V ($V_{in} = 3.9 \text{ V}$ to 10 V , $I_{out} = 0 \text{ mA}$)		–	0.5	2.5	
2.85 V ($V_{in} = 4.25 \text{ V}$ to 10 V , $I_{out} = 0 \text{ mA}$)		–	0.8	3.0	
3.3 V ($V_{in} = 4.75 \text{ V}$ to 15 V , $I_{out} = 0 \text{ mA}$)		–	0.8	4.5	
5.0 V ($V_{in} = 6.5 \text{ V}$ to 15 V , $I_{out} = 0 \text{ mA}$)		–	0.9	6.0	
12 V ($V_{in} = 13.5 \text{ V}$ to 20 V , $I_{out} = 0 \text{ mA}$)		–	1.0	7.5	
Load Regulation (Note 5) Adjustable ($I_{out} = 10 \text{ mA}$ to 800 mA , $V_{in} = 4.25 \text{ V}$)	Reg_{line}	–	0.2	0.4	%
1.5 V ($I_{out} = 0 \text{ mA}$ to 800 mA , $V_{in} = 2.9 \text{ V}$)		–	2.3	5.5	mV
1.8 V ($I_{out} = 0 \text{ mA}$ to 800 mA , $V_{in} = 3.2 \text{ V}$)		–	2.6	6.0	
1.9 V ($I_{out} = 0 \text{ mA}$ to 800 mA , $V_{in} = 3.3 \text{ V}$)		–	2.7	6.0	
2.0 V ($I_{out} = 0 \text{ mA}$ to 800 mA , $V_{in} = 3.4 \text{ V}$)		–	3.0	6.0	
2.5 V ($I_{out} = 0 \text{ mA}$ to 800 mA , $V_{in} = 3.9 \text{ V}$)		–	3.3	7.5	
2.85 V ($I_{out} = 0 \text{ mA}$ to 800 mA , $V_{in} = 4.25 \text{ V}$)		–	3.8	8.0	
3.3 V ($I_{out} = 0 \text{ mA}$ to 800 mA , $V_{in} = 4.75 \text{ V}$)		–	4.3	10	
5.0 V ($I_{out} = 0 \text{ mA}$ to 800 mA , $V_{in} = 6.5 \text{ V}$)		–	6.7	15	
12 V ($I_{out} = 0 \text{ mA}$ to 800 mA , $V_{in} = 13.5 \text{ V}$)		–	16	28	
Dropout Voltage (Measured at $V_{out} = 100 \text{ mV}$) ($I_{out} = 100 \text{ mA}$) ($I_{out} = 500 \text{ mA}$) ($I_{out} = 800 \text{ mA}$)	$V_{in}-V_{out}$	–	0.95 1.01 1.07	1.10 1.15 1.20	V
Output Current Limit ($V_{in}-V_{out} = 5.0 \text{ V}$, $T_A = 25^\circ\text{C}$, Note 6)	I_{out}	1000	1500	2200	mA
Minimum Required Load Current for Regulation, Adjustable Output Devices ($V_{in} = 15 \text{ V}$)	$I_{L(\text{min})}$	–	0.8	5.0	mA

ELECTRICAL CHARACTERISTICS (continued)

($C_{in} = 10 \mu\text{F}$, $C_{out} = 10 \mu\text{F}$, for typical value $T_A = 25^\circ\text{C}$, for min and max values T_A is the operating ambient temperature range that applies unless otherwise noted.) (Note 4)

Characteristic	Symbol	Min	Typ	Max	Unit	
Quiescent Current	I_Q	-	3.6	10	mA	
1.5 V ($V_{in} = 11.5 \text{ V}$)						
1.8 V ($V_{in} = 11.8 \text{ V}$)						
1.9 V ($V_{in} = 11.9 \text{ V}$)						
2.0 V ($V_{in} = 12 \text{ V}$)						
2.5 V ($V_{in} = 10 \text{ V}$)						
2.85 V ($V_{in} = 10 \text{ V}$)						
3.3 V ($V_{in} = 15 \text{ V}$)						
5.0 V ($V_{in} = 15 \text{ V}$)						
12 V ($V_{in} = 20 \text{ V}$)						
Thermal Regulation ($T_A = 25^\circ\text{C}$, 30 ms Pulse)		-	0.01	0.1	%/W	
Ripple Rejection ($V_{in}-V_{out} = 6.4 \text{ V}$, $I_{out} = 500 \text{ mA}$, 10 V _{pp} 120 Hz Sinewave)	RR		73	-	dB	
Adjustable						
1.5 V						67
1.8 V						66
1.9 V						66
2.0 V						64
2.5 V						62
2.85 V						62
3.3 V						60
5.0 V						57
12 V	50					
Adjustment Pin Current ($V_{in} = 11.25 \text{ V}$, $I_{out} = 800 \text{ mA}$)	I_{adj}	-	52	120	μA	
Adjust Pin Current Change ($V_{in}-V_{out} = 1.4 \text{ V}$ to 10 V , $I_{out} = 10 \text{ mA}$ to 800 mA)	ΔI_{adj}	-	0.4	5.0	μA	
Temperature Stability	S_T	-	0.5	-	%	
Long Term Stability ($T_A = 25^\circ\text{C}$, 1000 Hrs End Point Measurement)	S_t	-	0.3	-	%	
RMS Output Noise ($f = 10 \text{ Hz}$ to 10 kHz)	N	-	0.003	-	% V_{out}	

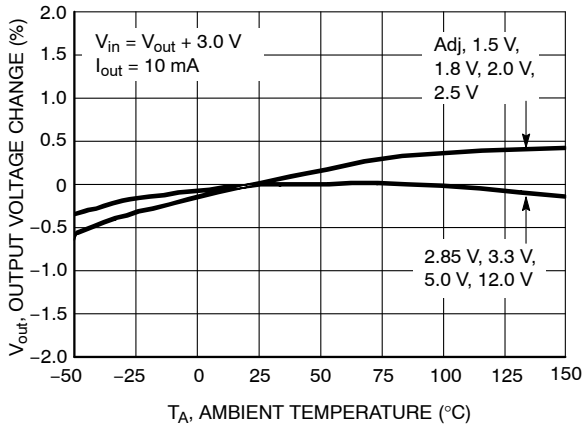

Figure 4. Output Voltage Change vs. Temperature

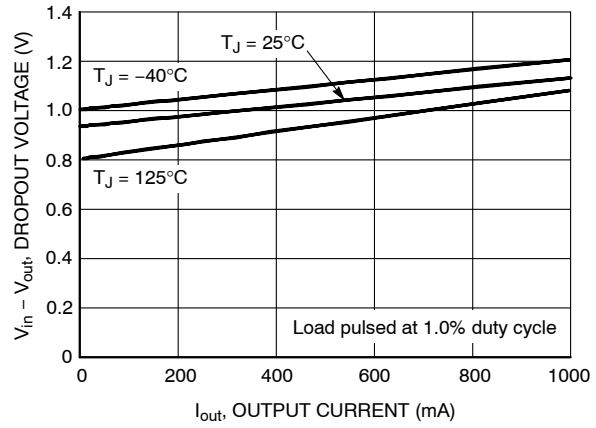

Figure 5. Dropout Voltage vs. Output Current

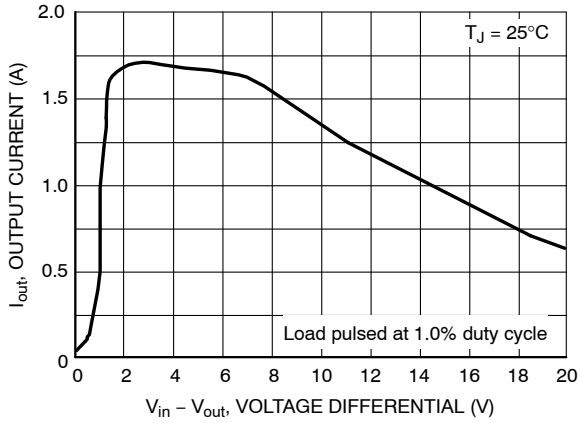

Figure 6. Output Short Circuit Current vs. Differential Voltage

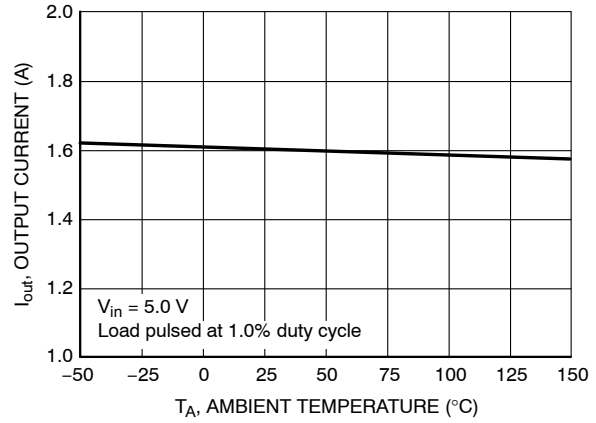

Figure 7. Output Short Circuit Current vs. Temperature

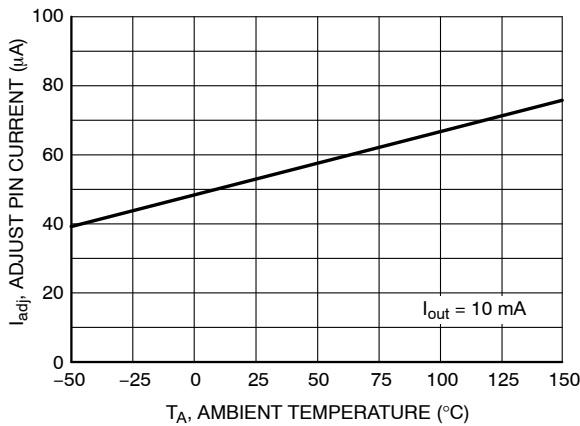

Figure 8. Adjust Pin Current vs. Temperature

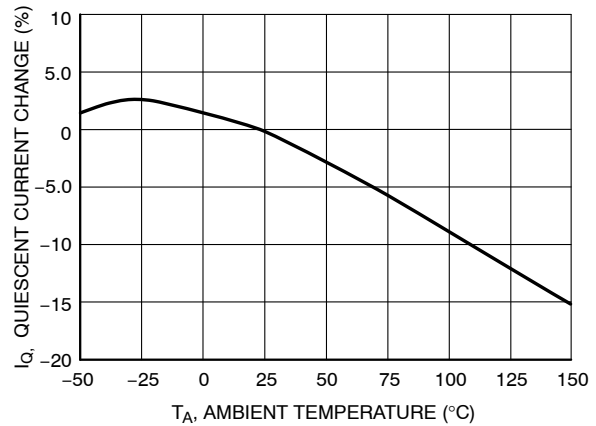

Figure 9. Quiescent Current Change vs. Temperature

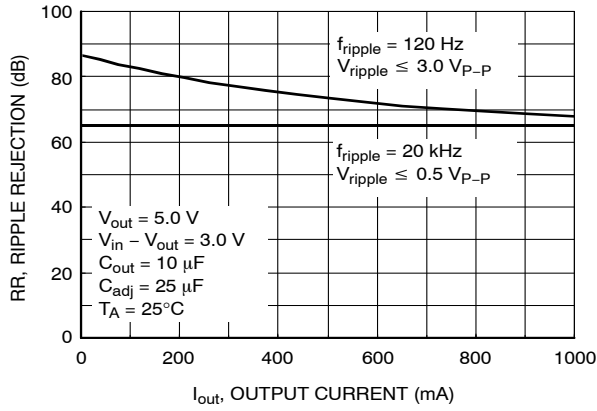

Figure 10. HT1117AT-ADJ Ripple Rejection vs. Output Current

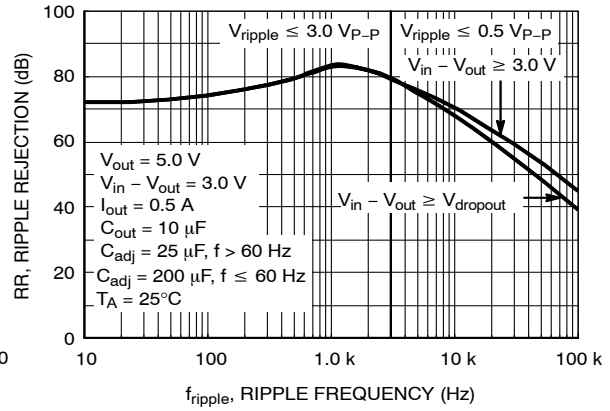

Figure 11. HT1117AT-ADJ Ripple Rejection vs. Frequency

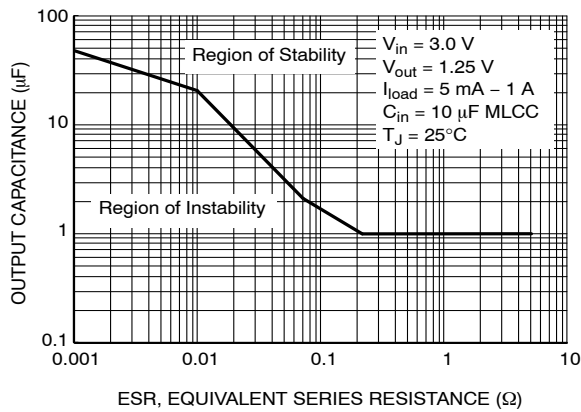

Figure 12. Output Capacitance vs. ESR

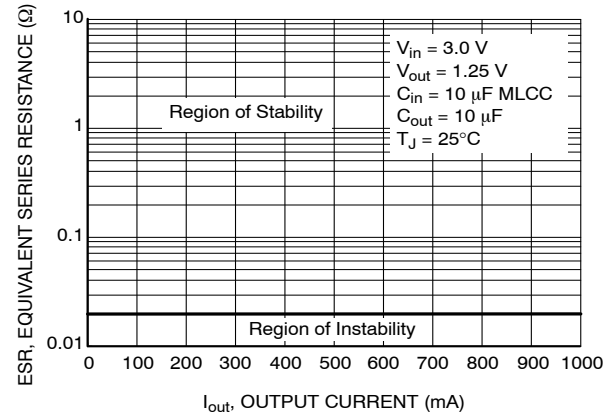

Figure 13. Typical ESR vs. Output Current

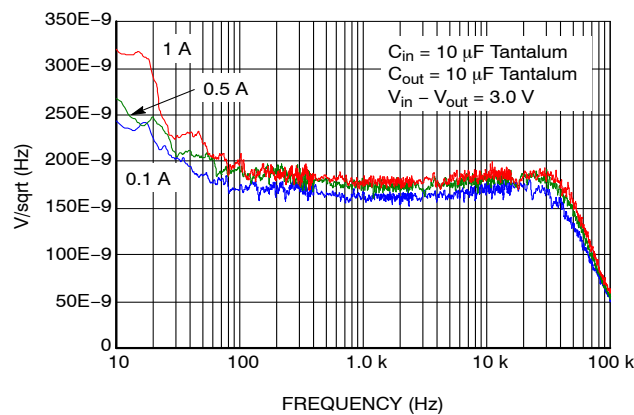
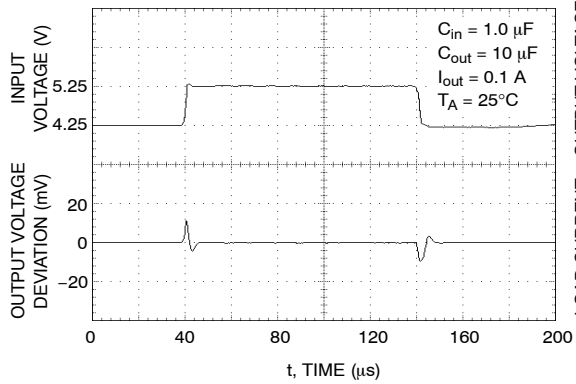
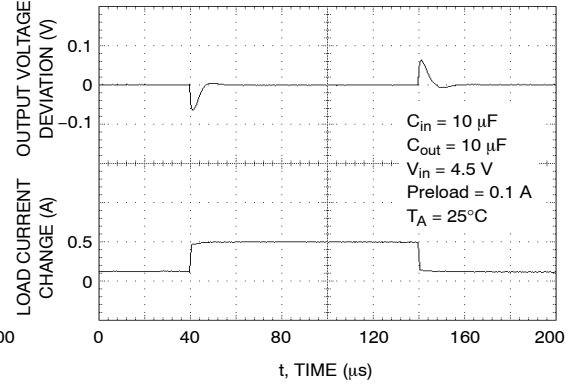

Figure 14. Output Spectral Noise Density vs. Frequency, $V_{out} = 1V5$



**Figure 15. HT1117AT-285
Line Transient Response**



**Figure 16. HT1117AT-285 Load
Transient Response**

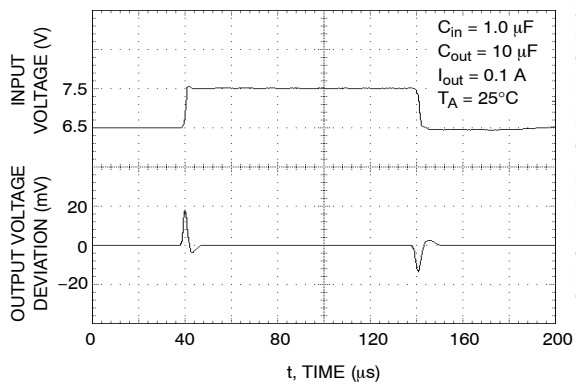

**Figure 17. HT1117AT-50
Line Transient Response**

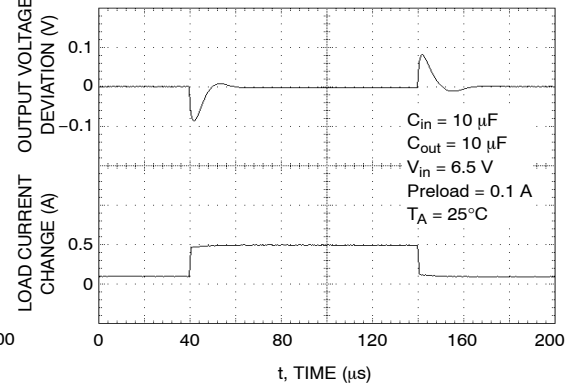

**Figure 18. HT1117AT-50
Load Transient Response**

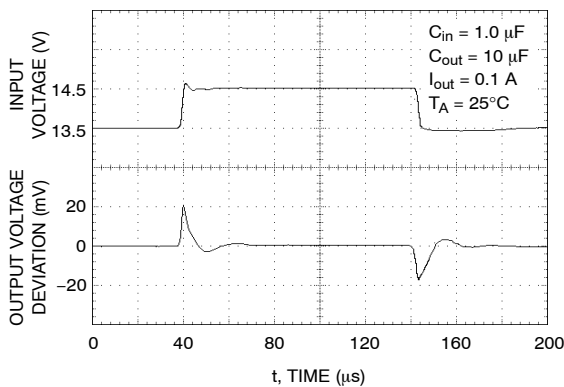

**Figure 19. HT1117AT-12
Line Transient Response**

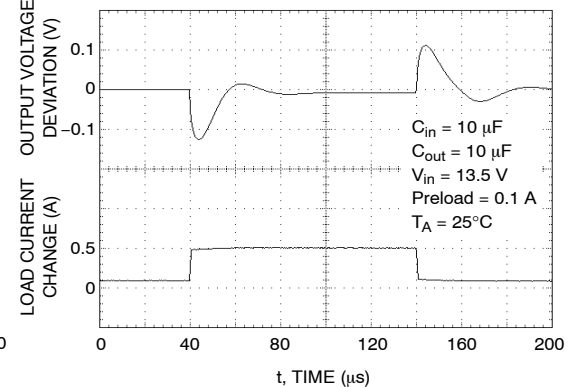

**Figure 20. HT1117AT-12
Load Transient Response**

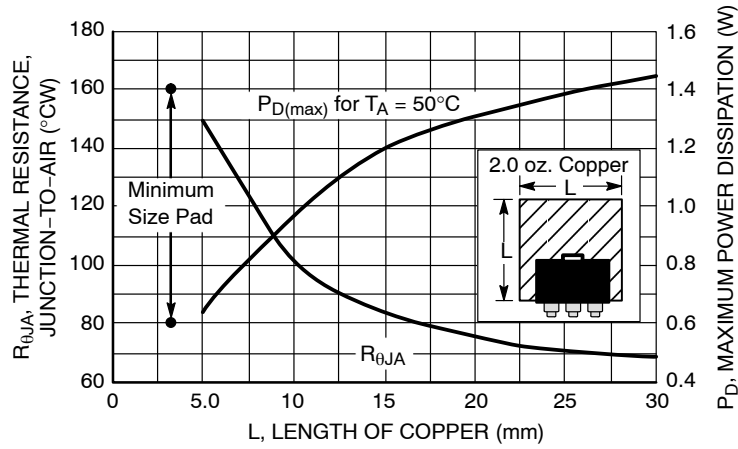

Figure 21. SOT-223 Thermal Resistance and Maximum Power Dissipation vs. P.C.B. Copper Length

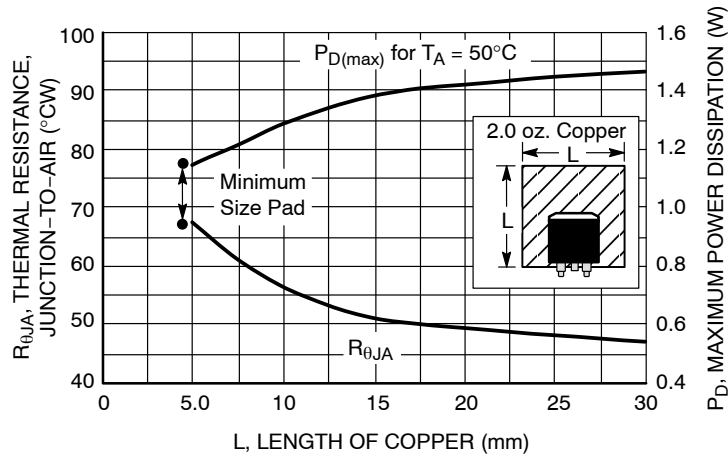

Figure 22. DPAK Thermal Resistance and Maximum Power Dissipation vs. P.C.B. Copper Length

Introduction

The HT1117 features a significant reduction in dropout voltage along with enhanced output voltage accuracy and temperature stability when compared to older industry standard three-terminal adjustable regulators. These devices contain output current limiting, safe operating area compensation and thermal shutdown protection making them designer friendly for powering numerous consumer and industrial products. The HT1117 series is pin compatible with the older LM317 and its derivative device types.

Output Voltage

The typical application circuits for the fixed and adjustable output regulators are shown in Figures 23 and 24. The adjustable devices are floating voltage regulators. They develop and maintain the nominal 1.25 V reference voltage between the output and adjust pins. The reference voltage is programmed to a constant current source by resistor R1, and this current flows through R2 to ground to set the output voltage. The programmed current level is usually selected to be greater than the specified 5.0 mA minimum that is required for regulation. Since the adjust pin current, I_{adj} , is significantly lower and constant with respect to the programmed load current, it generates a small output voltage error that can usually be ignored. For the fixed output devices R1 and R2 are included within the device and the ground current I_{gnd} , ranges from 3.0 mA to 5.0 mA depending upon the output voltage.

External Capacitors

Input bypass capacitor C_{in} may be required for regulator stability if the device is located more than a few inches from the power source. This capacitor will reduce the circuit's sensitivity when powered from a complex source impedance and significantly enhance the output transient response. The input bypass capacitor should be mounted with the shortest possible track length directly across the regulator's input and ground terminals. A 10 μ F ceramic or tantalum capacitor should be adequate for most applications.

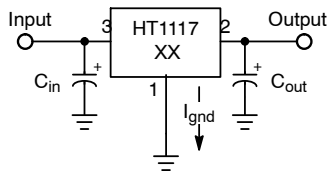

Figure 23. Fixed Output Regulator

Frequency compensation for the regulator is provided by capacitor C_{out} and its use is mandatory to ensure output stability. A minimum capacitance value of 4.7 μ F with an equivalent series resistance (ESR) that is within the limits of 33 m Ω (typ) to 2.2 Ω is required. See Figures 12 and 13. The capacitor type can be ceramic, tantalum, or aluminum electrolytic as long as it meets the minimum capacitance value and ESR limits over the circuit's entire operating temperature range. Higher values of output capacitance can be used to enhance loop stability and transient response with the additional benefit of reducing output noise.

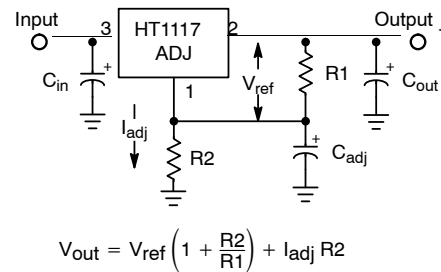

Figure 24. Adjustable Output Regulator

The output ripple will increase linearly for fixed and adjustable devices as the ratio of output voltage to the reference voltage increases. For example, with a 12 V regulator, the output ripple will increase by 12 V/1.25 V or 9.6 and the ripple rejection will decrease by 20 log of this ratio or 19.6 dB. The loss of ripple rejection can be restored to the values shown with the addition of bypass capacitor C_{adj} , shown in Figure 24. The reactance of C_{adj} at the ripple frequency must be less than the resistance of R1. The value of R1 can be selected to provide the minimum required load current to maintain regulation and is usually in the range of 100 Ω to 200 Ω .

$$C_{adj} > \frac{1}{2 \pi f_{ripple} R_1}$$

The minimum required capacitance can be calculated from the above formula. When using the device in an application that is powered from the AC line via a transformer and a full wave bridge, the value for C_{adj} is:

$$f_{ripple} = 120 \text{ Hz}, R_1 = 120 \Omega, \text{ then } C_{adj} > 11.1 \mu\text{F}$$

The value for C_{adj} is significantly reduced in applications where the input ripple frequency is high. If used as a post regulator in a switching converter under the following conditions:

$$f_{ripple} = 50 \text{ kHz}, R_1 = 120 \Omega, \text{ then } C_{adj} > 0.027 \mu\text{F}$$

Figures 10 and 11 shows the level of ripple rejection that is obtainable with the adjust pin properly bypassed.

Protection Diodes

The HT1117 family has two internal low impedance diode paths that normally do not require protection when used in the typical regulator applications. The first path connects between V_{out} and V_{in} , and it can withstand a peak surge current of about 15 A. Normal cycling of V_{in} cannot generate a current surge of this magnitude. Only when V_{in} is shorted or crowbarred to ground and C_{out} is greater than 50 μF , it becomes possible for device damage to occur. Under these conditions, diode D1 is required to protect the device. The second path connects between C_{adj} and V_{out} , and it can withstand a peak surge current of about 150 mA. Protection diode D2 is required if the output is shorted or crowbarred to ground and C_{adj} is greater than 1.0 μF .

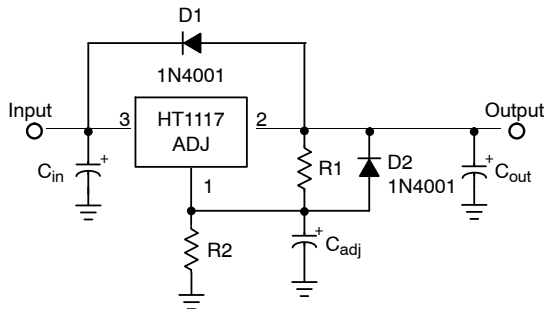

Figure 25. Protection Diode Placement

A combination of protection diodes D1 and D2 may be required in the event that V_{in} is shorted to ground and C_{adj} is greater than 50 μF . The peak current capability stated for the internal diodes are for a time of 100 μs with a junction temperature of 25°C. These values may vary and are to be used as a general guide.

Load Regulation

The HT1117 series is capable of providing excellent load regulation; but since these are three terminal devices, only partial remote load sensing is possible. There are two conditions that must be met to achieve the maximum available load regulation performance. The first is that the top side of programming resistor R1 should be connected as close to the regulator case as practicable. This will minimize the voltage drop caused by wiring resistance $RW+$ from appearing in series with reference voltage that is across R1.

The second condition is that the ground end of R2 should be connected directly to the load. This allows true Kelvin sensing where the regulator compensates for the voltage drop caused by wiring resistance $RW-$.

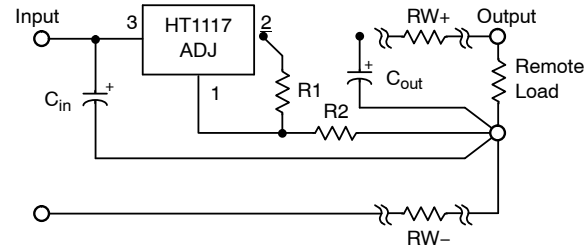

Figure 26. Load Sensing

Thermal Considerations

This series contains an internal thermal limiting circuit that is designed to protect the regulator in the event that the maximum junction temperature is exceeded. When activated, typically at 175°C, the regulator output switches off and then back on as the die cools. As a result, if the device is continuously operated in an overheated condition, the output will appear to be oscillating. This feature provides protection from a catastrophic device failure due to accidental overheating. It is not intended to be used as a substitute for proper heatsinking. The maximum device power dissipation can be calculated by:

$$PD = \frac{T_{J(max)} - T_A}{R_{\theta JA}}$$

The devices are available in surface mount SOT-223 and DPAK packages. Each package has an exposed metal tab that is specifically designed to reduce the junction to air thermal resistance, $R_{\theta JA}$, by utilizing the printed circuit board copper as a heat dissipater. Figures 21 and 22 show typical $R_{\theta JA}$ values that can be obtained from a square pattern using economical single sided 2.0 ounce copper board material. The final product thermal limits should be tested and quantified in order to insure acceptable performance and reliability. The actual $R_{\theta JA}$ can vary considerably from the graphs shown. This will be due to any changes made in the copper aspect ratio of the final layout, adjacent heat sources, and air flow.

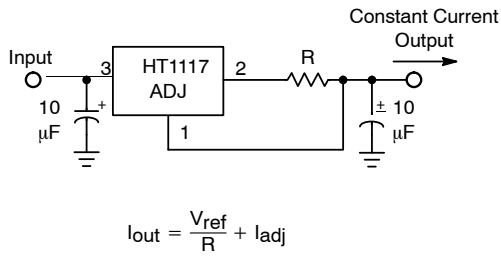
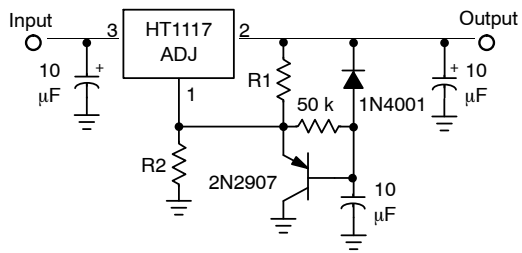
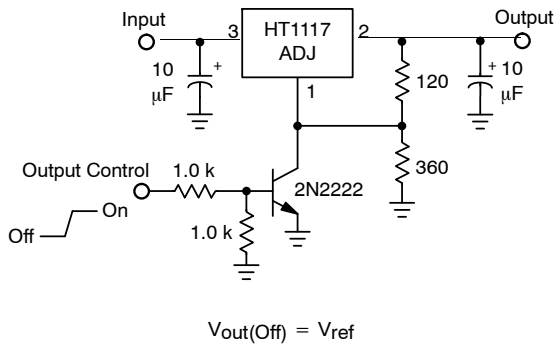
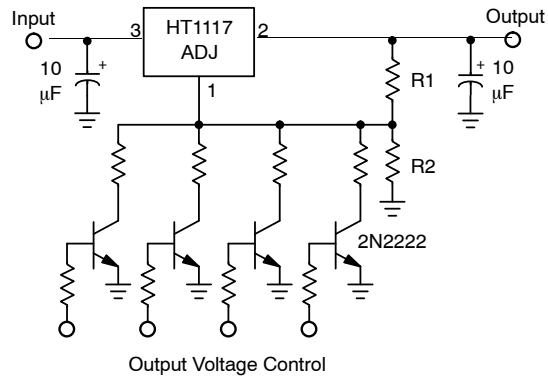
Figure 27. Constant Current Regulator

Figure 28. Slow Turn-On Regulator

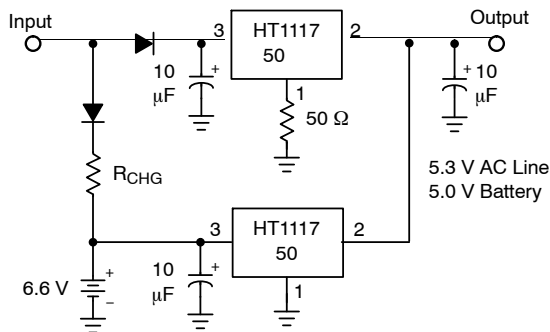
Figure 29. Regulator with Shutdown

Resistor R2 sets the maximum output voltage. Each transistor reduces the output voltage when turned on.

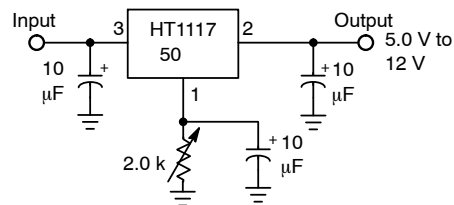
Figure 30. Digitally Controlled Regulator

The 50 Ω resistor that is in series with the ground pin of the upper regulator level shifts its output 300 mV higher than the lower regulator. This keeps the lower regulator off until the input source is removed.

Figure 31. Battery Backed-Up Power Supply

Figure 32. Adjusting Output of Fixed Voltage Regulators

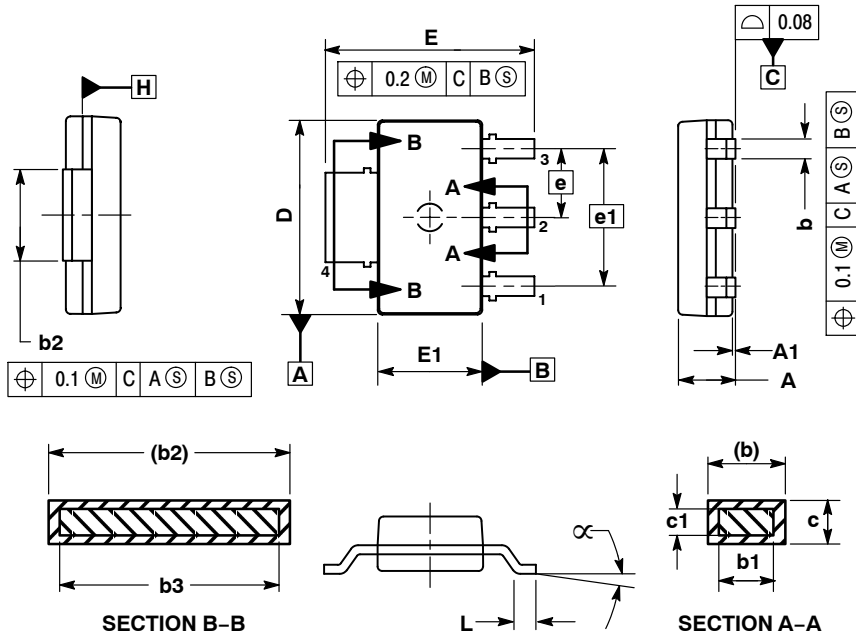
SOT-223



- NOTES:
1. DIMENSIONS ARE IN MILLIMETERS.
 2. INTERPRET DIMENSIONS AND TOLERANCES PER ASME Y14.5M, 1994.
 3. DIMENSION E1 DOES NOT INCLUDE INTERLEAD FLASH OR PROTRUSION. INTERLEAD FLASH OR PROTRUSION SHALL NOT EXCEED 0.23 PER SIDE.
 4. DIMENSIONS b AND b2 DO NOT INCLUDE DAMBAR PROTRUSION. ALLOWABLE DAMBAR PROTRUSION SHALL BE 0.08 TOTAL IN EXCESS OF THE b AND b2 DIMENSIONS AT MAXIMUM MATERIAL CONDITION.
 5. TERMINAL NUMBERS ARE SHOWN FOR REFERENCE ONLY.
 6. DIMENSIONS D AND E1 ARE TO BE DETERMINED AT DATUM PLANE H.

DIM	MILLIMETERS	
	MIN	MAX
A	---	1.80
A1	0.02	0.11
b	0.60	0.88
b1	0.60	0.80
b2	2.90	3.10
b3	2.90	3.05
c	0.24	0.35
c1	0.24	0.30
D	6.30	6.70
E	6.70	7.30
E1	3.30	3.70
e	2.30	
e1	4.60	
L	0.25	---
α	0°	10°

SOLDERING FOOTPRINT*

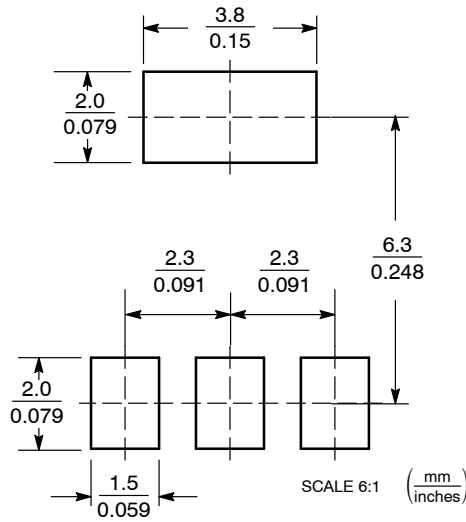

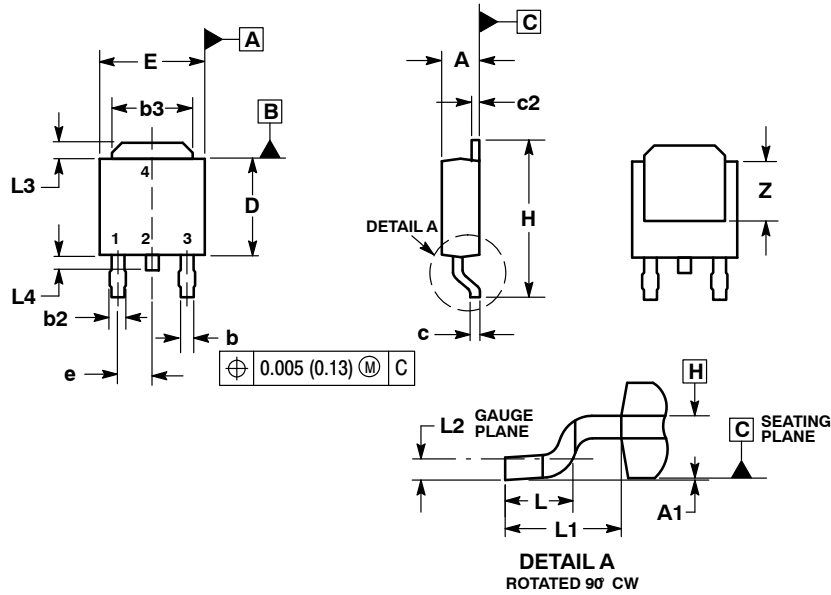
TO252

NOTES:

1. DIMENSIONING AND TOLERANCING PER ASME Y14.5M, 1994.
2. CONTROLLING DIMENSION: INCHES.
3. THERMAL PAD CONTOUR OPTIONAL WITHIN DIMENSIONS b3, L3 and Z.
4. DIMENSIONS D AND E DO NOT INCLUDE MOLD FLASH, PROTRUSIONS, OR BURRS. MOLD FLASH, PROTRUSIONS, OR GATE BURRS SHALL NOT EXCEED 0.006 INCHES PER SIDE.
5. DIMENSIONS D AND E ARE DETERMINED AT THE OUTERMOST EXTREMES OF THE PLASTIC BODY.
6. DATUMS A AND B ARE DETERMINED AT DATUM PLANE H.

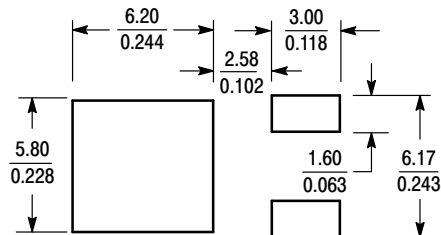
DIM	INCHES		MILLIMETERS	
	MIN	MAX	MIN	MAX
A	0.086	0.094	2.18	2.38
A1	0.000	0.005	0.00	0.13
b	0.025	0.035	0.63	0.89
b2	0.030	0.045	0.76	1.14
b3	0.180	0.215	4.57	5.46
c	0.018	0.024	0.46	0.61
c2	0.018	0.024	0.46	0.61
D	0.235	0.245	5.97	6.22
E	0.250	0.265	6.35	6.73
e	0.090 BSC		2.29 BSC	
H	0.370	0.410	9.40	10.41
L	0.055	0.070	1.40	1.78
L1	0.108 REF		2.74 REF	
L2	0.020 BSC		0.51 BSC	
L3	0.035	0.050	0.89	1.27
L4	---	0.040	---	1.01
Z	0.155	---	3.93	---

SOLDERING FOOTPRINT*

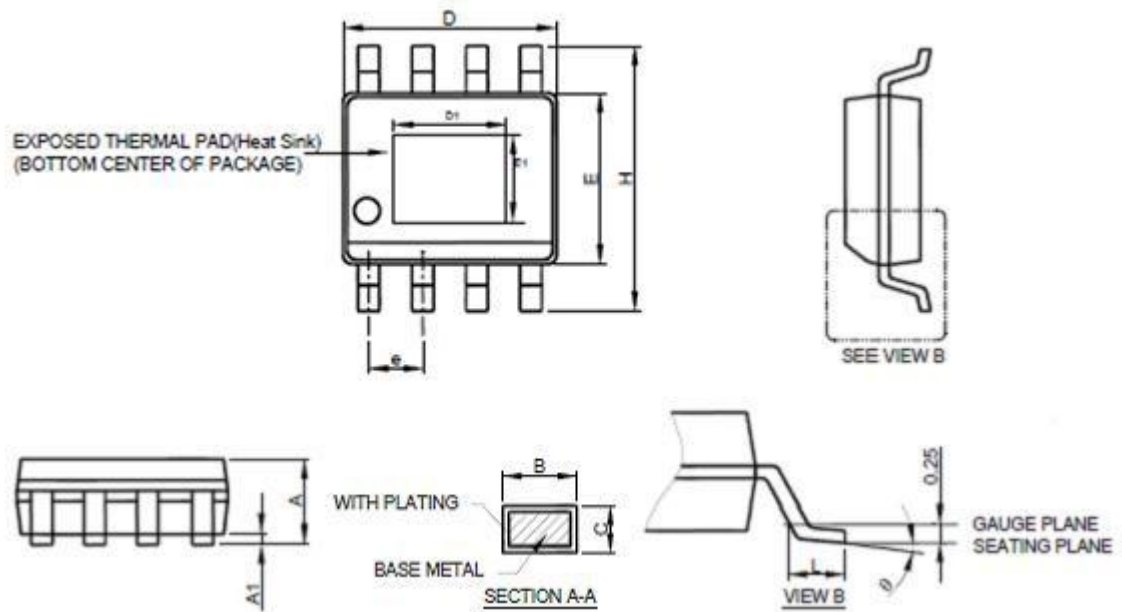
ESOP8

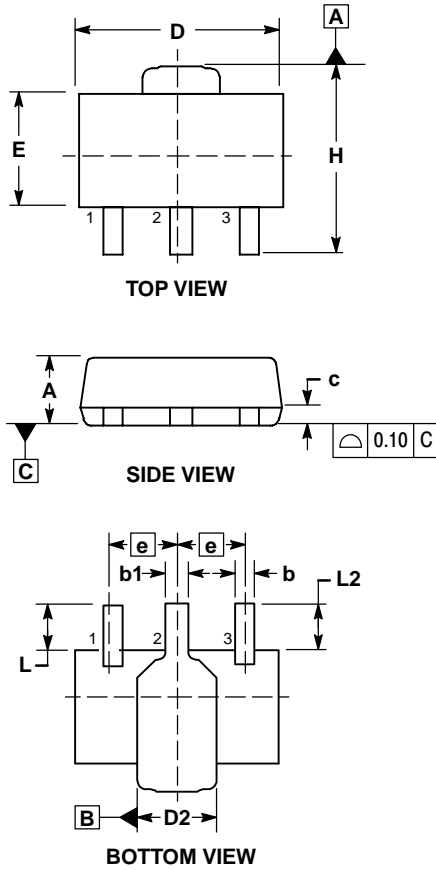

Symbol	Dimensions In Millimeters	
	Min	Max
A	1.35	1.75
A1	0.05	0.25
B	0.31	0.51
C	0.17	0.25
D	4.70	5.10
E	3.70	4.10
e	1.27BSC	
H	5.80	6.20

SOT-89

- NOTES:
1. DIMENSIONING AND TOLERANCING PER ASME Y14.5M, 1994.
 2. CONTROLLING DIMENSION: MILLIMETERS.
 3. LEAD THICKNESS INCLUDES LEAD FINISH.
 4. DIMENSIONS D AND E DO NOT INCLUDE MOLD FLASH, PROTRUSIONS, OR GATE BURRS.
 5. DIMENSIONS L, L2, D2, AND H ARE MEASURED AT DATUM PLANE C.
 6. CENTER LEAD CONTOUR MAY VARY WITHIN THE REGION DEFINED BY DIMENSION E.
 7. DIMENSION D2 IS DEFINED AT ITS WIDEST POINT.

MILLIMETERS		
DIM	MIN	MAX
A	1.40	1.60
b	0.38	0.47
b1	0.46	0.55
c	0.40	0.44
D	4.40	4.60
D2	1.60	1.90
E	2.40	2.60
e	1.50 BSC	
H	4.05	4.25
L	0.89	1.20

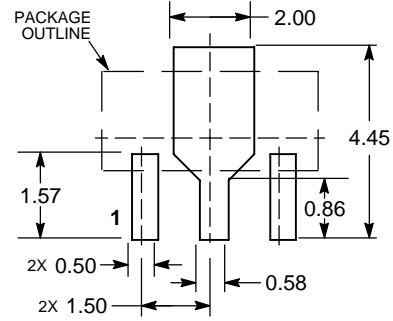
RECOMMENDED MOUNTING FOOTPRINT*

DIMENSIONS: MILLIMETERS

*For additional information on our Pb-Free strategy and soldering details, please download the ON Semiconductor Soldering and Mounting Techniques Reference Manual, SOLDERRM/D.

DFN8 4*4

DRJ (S-PWSON-N8)

PLASTIC SMALL OUTLINE NO-LEAD

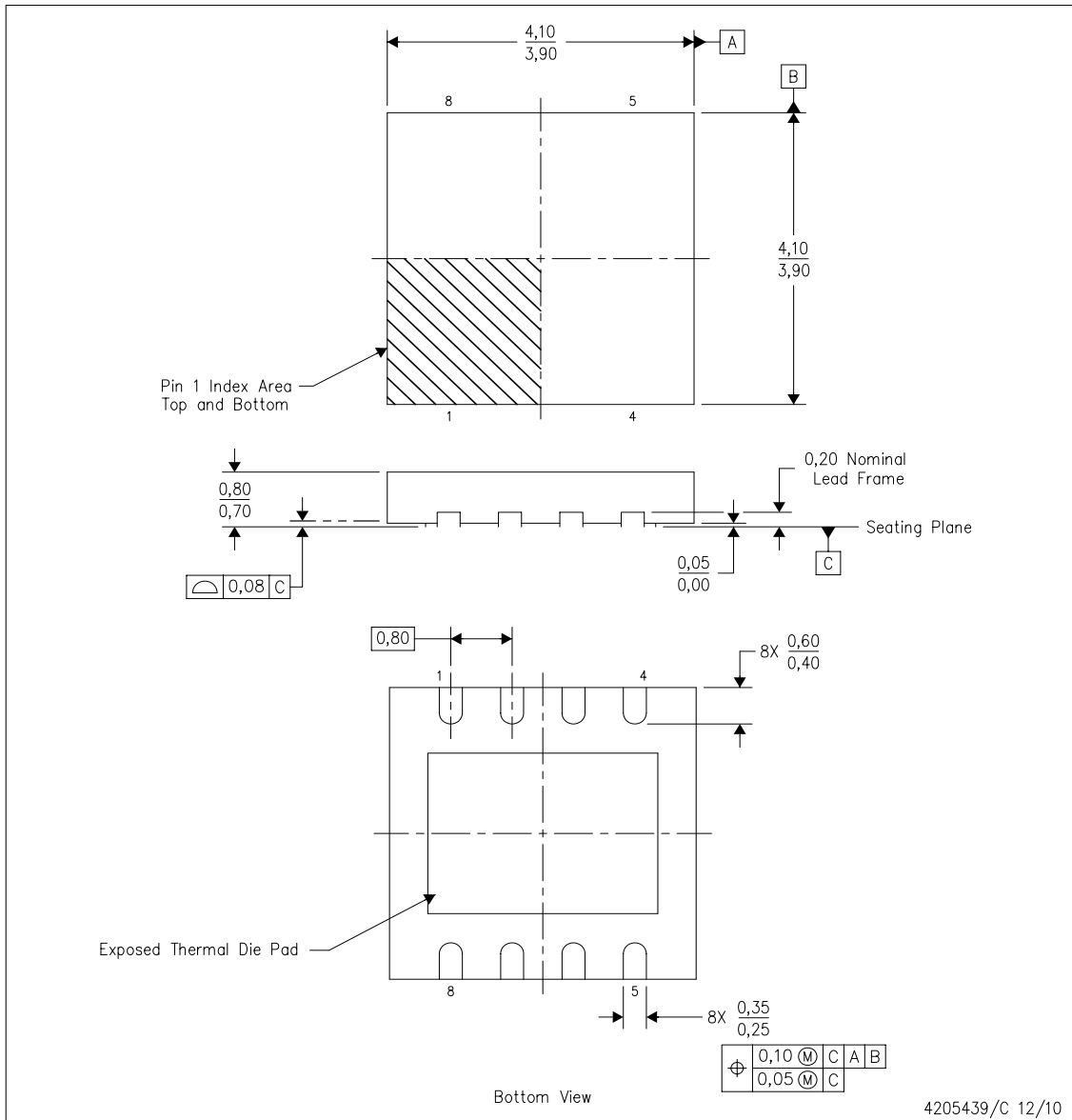

X-ON Electronics

Largest Supplier of Electrical and Electronic Components

Click to view similar products for [Linear Voltage Regulators](#) category:

Click to view products by [HTCSEMI](#) manufacturer:

Other Similar products are found below :

[LV5684PVD-XH](#) [MCDTSA6-2R](#) [L7815ACV-DG](#) [LV56801P-E](#) [UA7805CKC](#) [714954EB](#) [ZMR500QFTA](#) [BA033LBSG2-TR](#)
[NCV78M05ABDTRKG](#) [LV5680P-E](#) [L79M05T-E](#) [L78LR05D-MA-E](#) [NCV317MBTG](#) [NTE7227](#) [MP2018GZD-33-P](#) [MP2018GZD-5-P](#)
[LV5680NPVC-XH](#) [ZTS6538SE](#) [UA78L09CLP](#) [UA78L09CLPR](#) [CAT6221-PPTD-GT3](#) [MC78M09CDTRK](#) [NCV51190MNTAG](#)
[BL1118CS8TR1833](#) [BL8563CKETR18](#) [BL8077CKETR33](#) [BL9153-33CC3TR](#) [BL9161G-15BADRN](#) [BL9161G-28BADRN](#)
[BRCO7530MMC](#) [CJ7815B-TFN-ARG](#) [LM317C](#) [GM7333K](#) [GM7350K](#) [XC6206P332MR](#) [HT7533](#) [LM7912S/TR](#) [LT1764S/TR](#) [LM7805T](#)
[LM338T](#) [LM1117IMP-3.3/TR](#) [HT1117AM-3.3](#) [HT7550S](#) [AMS1117-3.3](#) [HT7150S](#) [78L12](#) [HT7550](#) [HT7533-1](#) [HXY6206I-2.5](#) [HT7133](#)