

6MHz, Rail-to-Rail I/O CMOS Op Amps

概述

HT1348、HT2348 和 HT4348 分别是单通道、双通道和四通道、轨到轨输入和输出、单电源放大器，具有极低的失调电压和宽信号带宽。这些放大器采用新型专利微调技术，无需激光微调便可达到出色的性能。所有器件均可采用 3 V 至 5 V 单电源供电。低失调、极低的输入偏置电流和高速度特性相结合，使这些放大器适合各种应用。滤波器、积分器、二极管放大器、分流传感器和高阻抗传感器等器件均可受益于这些特性组合。宽带宽和低失真特性则有益于音频和其它交流应用。对于大部分成本敏感型应用，C 级可在较低的价位下提供一样的交流性能，但直流精度较低。这些放大器的具体应用包括：便携式设备的音频放大、便携式电话耳机、条形码扫描器、便携式仪器仪表、蜂窝 PA 控制以及多极滤波器。它还具有轨到轨输入与输出摆幅能力，因而设计人员可以在单电源系统中缓冲 CMOS ADC、DAC、ASIC 及其它宽输出摆幅器件。

产品特性

低失调电压：**500uV(最大值)** 单电源供电：**2.7 V 至 5.5 V**
 低电源电流：每个放大器 **380uA** 带宽：**6 MHz**
 压摆率：**5 V/us**
 低失真
 无相位反转
 低输入电流
 单位增益稳定
 通过汽车应用认证

应用

电流检测
 条形码扫描器
PA 控制
 电池供电仪器仪表
 多极滤波器
 传感器
ASIC 输入或输出放大器
 音频

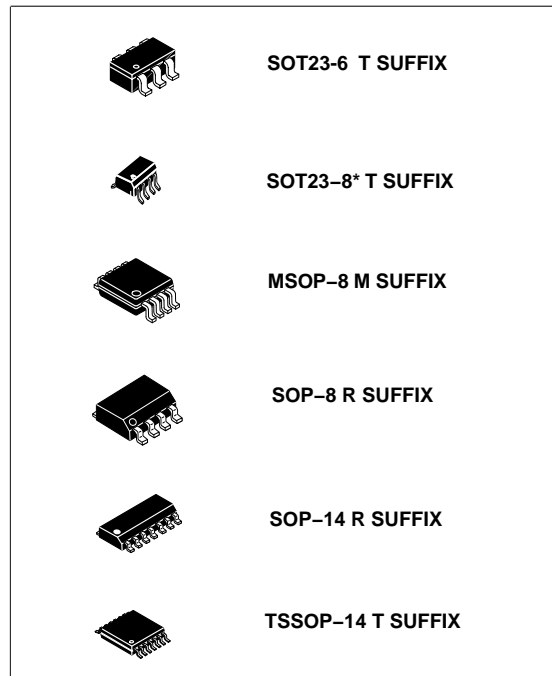

引脚配置

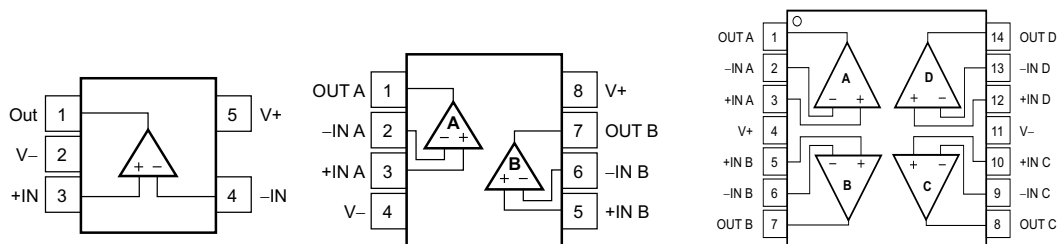

Absolute Maximum Ratings

(If out of these ratings, the filter may be fail or damaged)

Table 1

Symbol	parameter	rating	units
VDD	Power supply	6	V
T _A	Operating ambient Temperature Range	-40~+125	°C
T _{STG}	Storage Temperature	-65~+150	°C

Recommended Operating Conditions

Table 2

Symbol	parameter	rating	units
VDD	Power supply	2.5~5.5	V
T _A	Operating ambient Temperature Range	-40~+125	°C

Electrical Characteristics

 Specifications are at $T_A=+27^{\circ}\text{C}$, $V_{DD}=5\text{V}$, $V_{CM}=V_{OUT}=V_{DD}/2$, $R_L=10\text{Kohm}$, $C_L=100\text{pF}$

Symbol	Parameter	Spec			Units
		Min	Typ	Max	
VCC	Operating Supply Voltage	2.5	5	5.5	V
V _{OS}	Input Offset Voltage	-1	+/-0.5	+1	mV
V _{OS_TC}	Input Offset voltage Temp Drift		4		$\mu\text{V}/^{\circ}\text{C}$
e _n	Input Voltage Noise Density: f=1KHz		25		nV/ $\sqrt{\text{Hz}}$
C _{IN}	Input Capacitance	Differential	1.5		pF
		Common Mode	3.0		
R _{IN}	Input Resistance	>100			G Ω
I _Q	Quiescent Current per Amplifier		330	590	μA
I _{out}	Output Current		50		mA
V _{in_cm}	Common mode Input voltage	0		VDD-0.1	V
V _{OL}	Output Voltage from supply Swing		10		mV
CMRR	Common Mode Rejection Ratio		100		dB
I _{sc}	Output short-circuit current		80		mA
PM	Phase Margin		65		$^{\circ}$
GM	Gain Margin		-10		dB
GBWP	Gain-Bandwidth Product		6		MHz
PSRR	Power supply rejection ratio: 1Hz 1KHz		100		dB
			72		
t _s	Settling time, 1.5V to 3.5V, Unity Gain: 0.1%		0.46		μs
SR	Slew Rate		3.7		μs
THD+Noise	Total Harmonic Distortion and Noise: f=1KHz		0.0007		%

Typical performance characteristics

At $T_A=+27^\circ\text{C}$, $V_{DD}=5\text{V}$, $V_{CM}=V_{OUT}=V_{DD}/2$, $R_L=10\text{Kohm}$, $C_L=100\text{pF}$

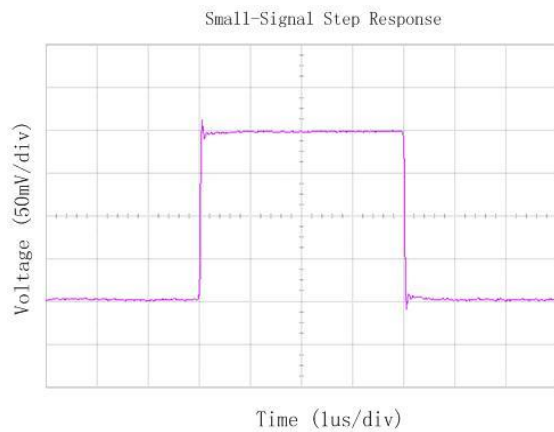
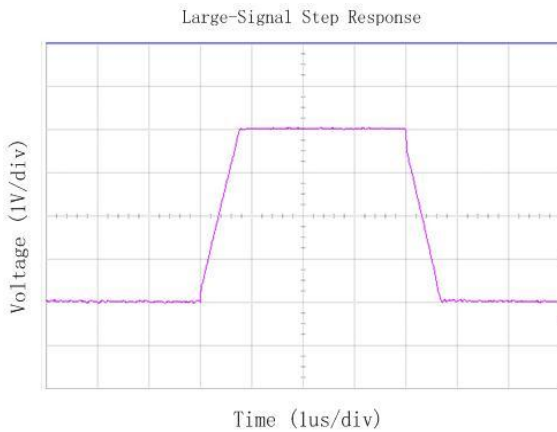
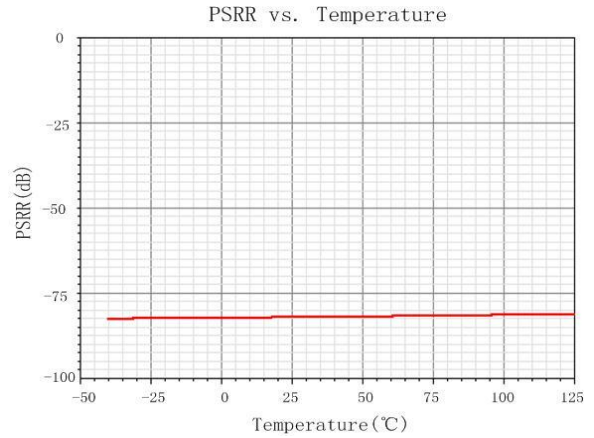
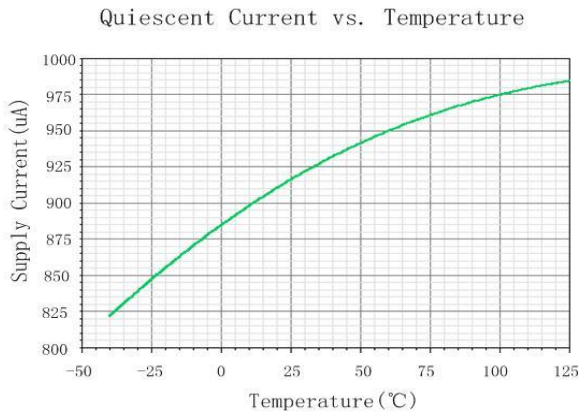
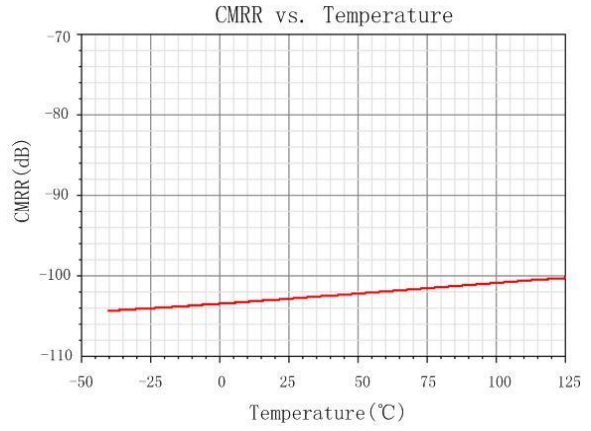
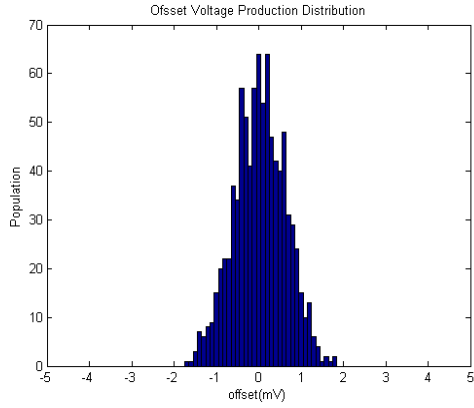

Application Circuits

The HTX348A of operational amplifier can operate with power supply voltages from 2.5V to 5.5V. Each amplifier draws only 380uA quiescent current. The HTX348A can driver larger capacitive loads in unity-gain without oscillation. The unity-gain follower (buffer) is the most sensitive configuration to capacitive loading. When driving large capacitive loads with the HTX348A OPA, a small series resistor at the output improves the feedback loop's phase margin and stability by making the output load resistive at higher frequencies.

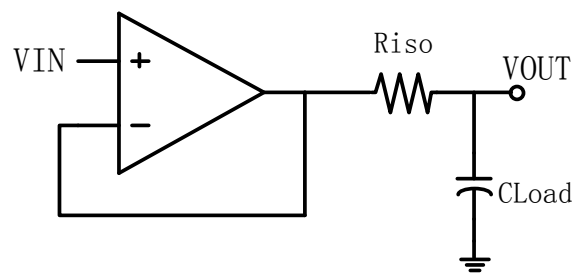

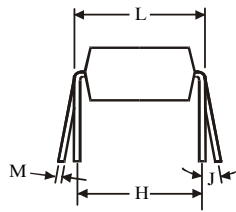
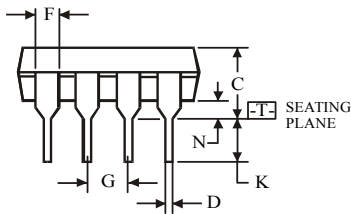
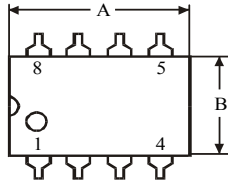
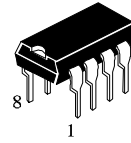
(DIP8)

 $\oplus 0.25 (0.010) \text{ (M) T}$

Symbol	Dimension, mm	
	MIN	MAX
A	8.51	10.16
B	6.1	7.11
C		5.33
D	0.36	0.56
F	1.14	1.78
G	2.54	
H	7.62	
J	0°	10°
K	2.92	3.81
L	7.62	8.26
M	0.2	0.36
N	0.38	

NOTES:

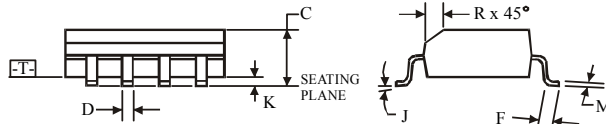
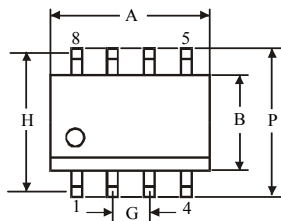
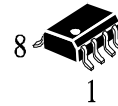
- Dimensions "A", "B" do not include mold flash or protrusions.
Maximum mold flash or protrusions 0.25 mm (0.010) per side.

(SOP8)

 $\oplus 0.25 (0.010) \text{ (M) T C (M)}$

Symbol	Dimension, mm	
	MIN	MAX
A	4.8	5
B	3.8	4
C	1.35	1.75
D	0.33	0.51
F	0.4	1.27
G	1.27	
H	5.72	
J	0°	8°
K	0.1	0.25
M	0.19	0.25
P	5.8	6.2
R	0.25	0.5

NOTES:

- Dimensions A and B do not include mold flash or protrusion.
- Maximum mold flash or protrusion 0.15 mm (0.006) per side for A; for B - 0.25 mm (0.010) per side.

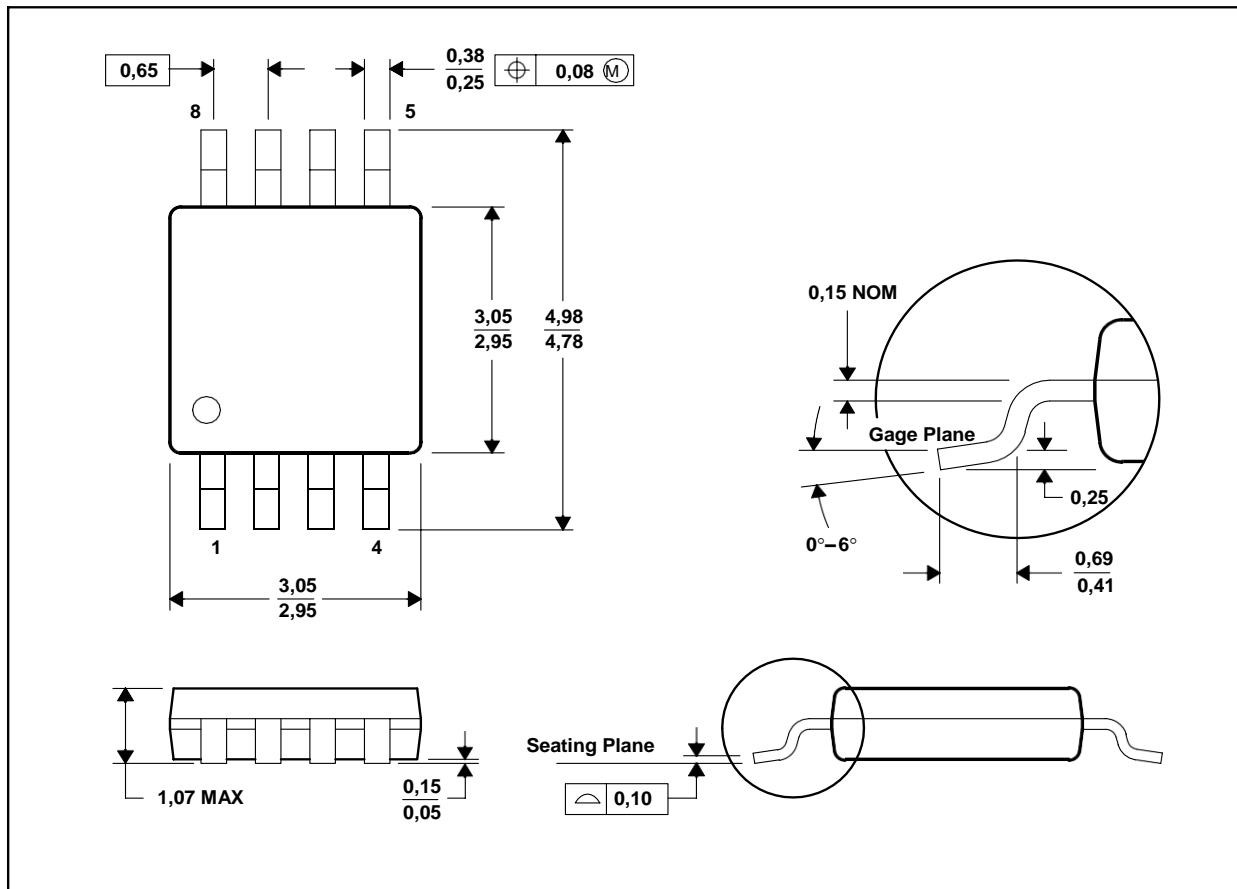
MSOP8



TSSOP8

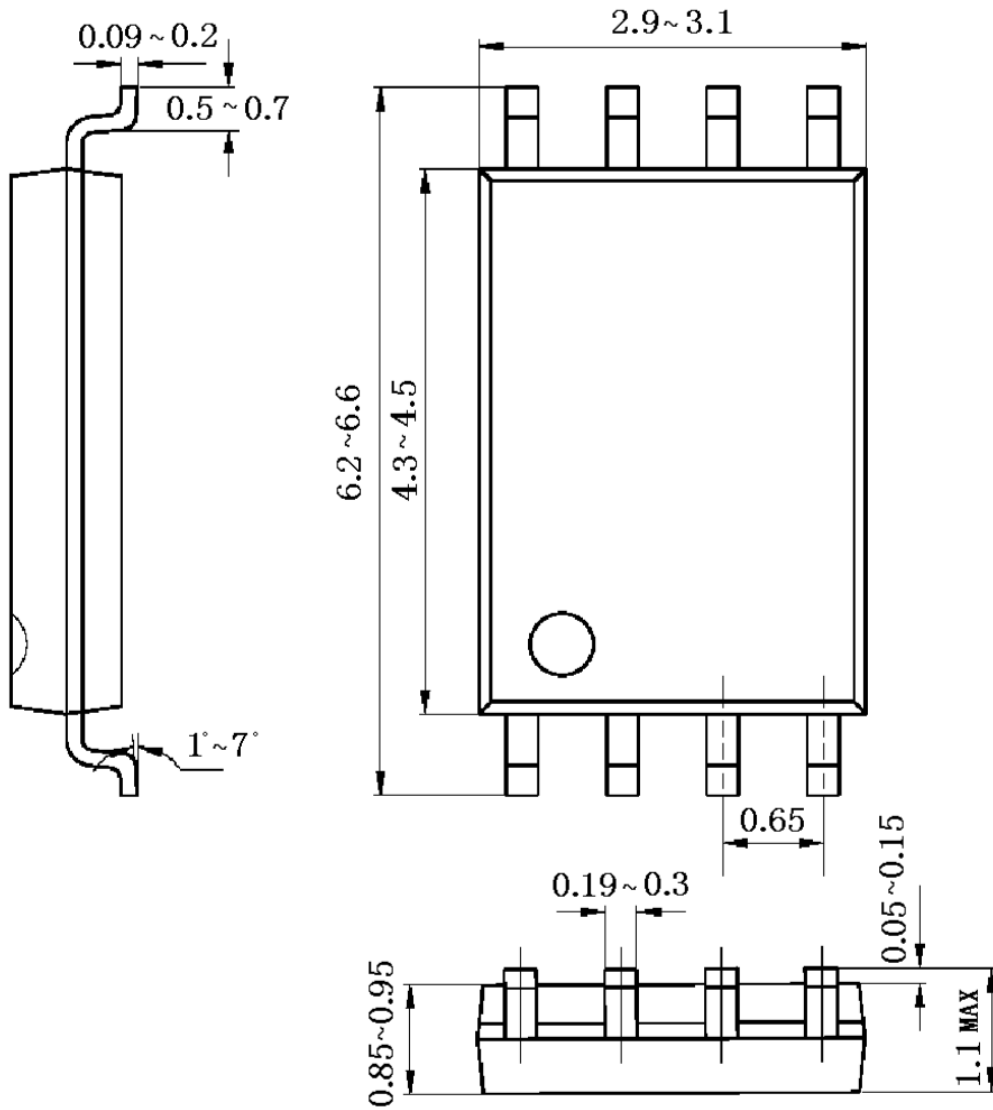

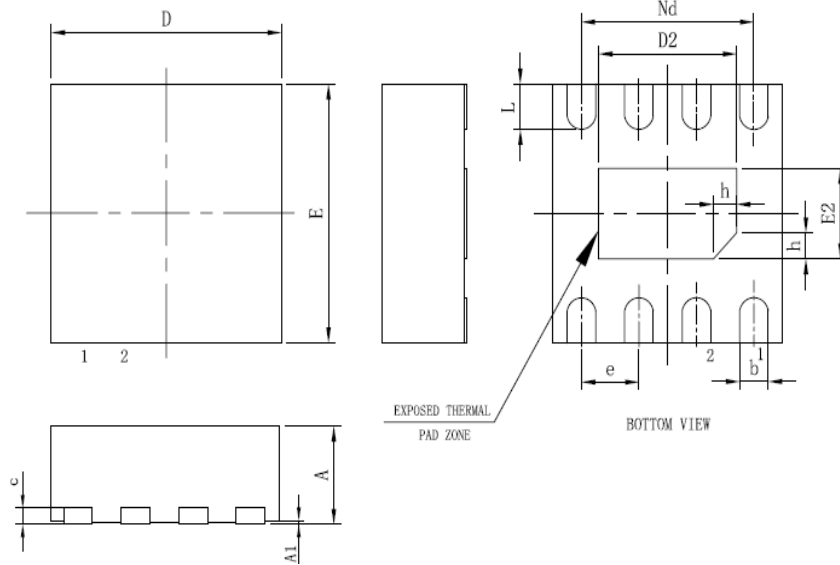
DFN-8L

SYMBOL	MILLIMETER		
	MIN	NOM	MAX
A	0.70	0.75	0.80
A1	—	0.02	0.05
b	0.18	0.25	0.30
c	0.18	0.20	0.25
D	1.90	2.00	2.10
D2	1.10	1.20	1.30
e	0.50BSC		
Nd	1.50BSC		
E	1.90	2.00	2.10
E2	0.60	0.70	0.80
L	0.30	0.35	0.40
h	0.15	0.20	0.25
载体尺寸 (mm)	63X39		

SOT23-8L

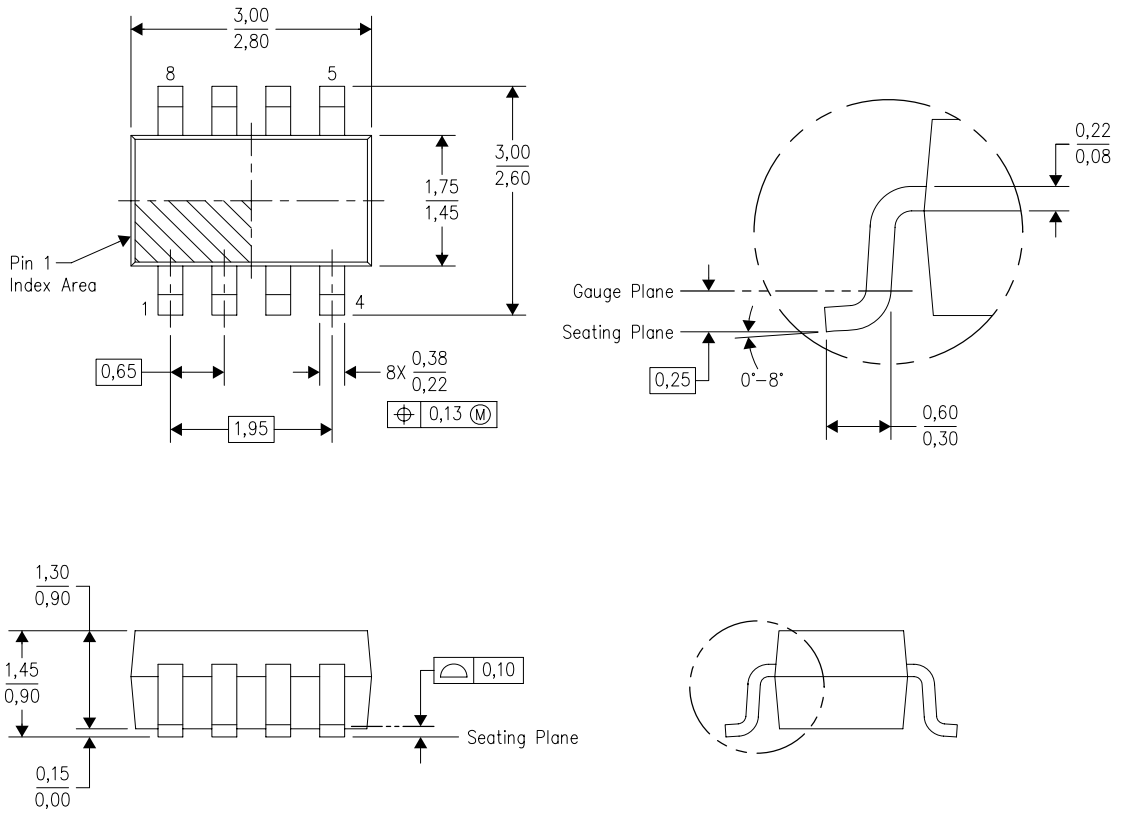

X-ON Electronics

Largest Supplier of Electrical and Electronic Components

Click to view similar products for [Operational Amplifiers - Op Amps](#) category:

Click to view products by [HTCSEMI](#) manufacturer:

Other Similar products are found below :

[SC2902DTBR2G](#) [LM358SNG](#) [430227FB](#) [UPC451G2-A](#) [UPC824G2-A](#) [LT1678IS8](#) [042225DB](#) [058184EB](#) [UPC822G2-A](#) [UPC258G2-A](#)
[NCS5651MNTXG](#) [NCV33202DMR2G](#) [NJM324E](#) [NTE925](#) [5962-9080901MCA*](#) [AZV358MTR-G1](#) [AP4310AUMTR-AG1](#)
[HA1630D02MMEL-E](#) [HA1630S01LPEL-E](#) [AZV358MMTR-G1](#) [SCY33178DR2G](#) [NJU77806F3-TE1](#) [NCV5652MUTWG](#) [NCV20034DR2G](#)
[NTE778S](#) [NTE871](#) [NTE924](#) [NTE937](#) [MCP6V16UT-E/OT](#) [MCP6V17T-E/MS](#) [MCP6V19T-E/ST](#) [SCY6358ADR2G](#) [NCS20282FCTTAG](#)
[LM4565FVT-GE2](#) [EL5420CRZ-T7A](#) [TSV772IQ2T](#) [TSV792IYST](#) [NJM2100M-TE1](#) [COS2262MR](#) [COS2252MR](#) [COS5532SRB](#)
[COS2272MR](#) [LMV358MR](#) [COS6002MR](#) [LMV358SR](#) [LM358SR](#) [RC4580MM/TR](#) [HGV8544M/TR](#) [HGV8541M/TR](#) [HGV8634M/TR](#)