

DUAL OPERATIONAL AMPLIFIER

(compatible to NJM4560 (JRC))



■ GENERAL DESCRIPTION

HT4560B is the dual operational amplifier, specially designed for improving the tone control, which is most suitable for the audio application.

Featuring noiseless, higher gain bandwidth, high output current and low distortion ratio, and it is most suitable not only for acoustic electronic parts of audio pre-amp and active filter, but also for the industrial measurement tools. It is also suitable for the head phone amp at higher output current, and further more, it can be applied for the handy type set operational amplifier of general purpose in application of low voltage single supply type which is properly biased of the low voltage source.

■ FEATURES

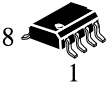
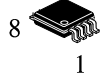
- Operating Voltage ($\pm 2V \sim \pm 18V$)
- Low Input Noise Voltage ($0.8\mu V_{rms}$ typ.)
- Wide Gain Bandwidth Product ($15MHz$ typ.)
- Low Distortion (0.0005% typ.)
- Slew Rate ($5V/\mu s$ typ.)
- Package Outline DIP8, SIP8, SOP8, MSOP8, WSOP8
- Bipolar Technology

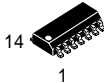
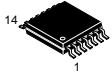
 8 1	SOP8 R SUFFIX HT4560BRZ
 8 1	MSOP8 M SUFFIX HT4560BRMZ
	DFN8(2*2) Q SUFFIX HT4560BRQZ
 14 1	QFN8(2*2) R SUFFIX HT4564BRZ
 14 1	TSSOP14 T SUFFIX HT4564BRTZ
$T_A = -40^\circ$ to $85^\circ C$ for all packages.	

■ PIN CONFIGURATION

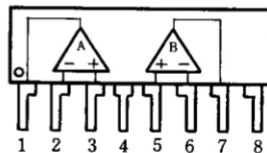
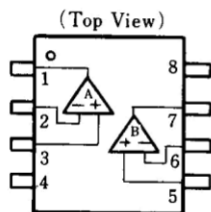

PIN FUNCTION

- 1.A OUTPUT
- 2.A -INPUT
- 3.A +INPUT
- 4.V⁻
- 5.B +INPUT
- 6.B -INPUT
- 7.B OUTPUT
- 8.V⁺

■ EQUIVALENT CIRCUIT

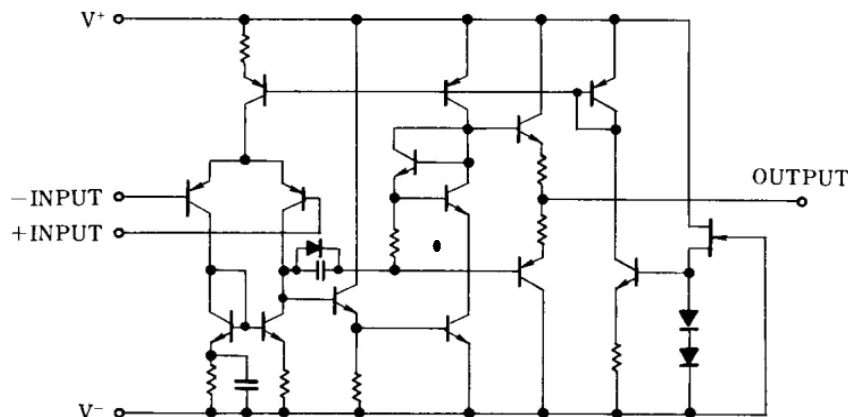

■ ABSOLUTE MAXIMUM RATINGS

(Ta=25°C)

PARAMETER	SYMBOL	RATINGS	UNIT
Supply Voltage	V^+ / V^-	± 18	V
Input Voltage	V_{ic}	± 15 (Note)	V
Differential Input Voltage	V_{ID}	± 30	V
Output Current	I_o	± 50	mA
Power Dissipation	P_d	(DIP8) 800 (SIP8) 800 (SOP8) 300 (MSOP8) 300 (WSOP8) 250	mW
Operating Temperature Range	T_{opr}	-40~+85	°C
Storage Temperature Range	T_{stg}	-40~+125	°C

 (Note) For supply voltage less than $\pm 15V$, the absolute maximum rating is equal to the supply voltage.

■ ELECTRICAL CHARACTERISTICS

 (Ta=25°C, $V^+ / V^- = \pm 15V$)

PARAMETER	SYMBOL	TEST CONDITION	MIN.	TYP.	MAX.	UNIT
Input Offset Voltage	V_{io}	$R_s \leq 10k\Omega$	-	0.5	3	mV
Input Offset Current	I_{io}		-	5	200	nA
Input Bias Current	I_B		-	100	500	nA
Large Signal Voltage Gain	A_v	$R_L \geq 2k\Omega, V_o = \pm 10V$	90	110	-	dB
Output Voltage Swing	V_{OM}	$R_L \geq 2k\Omega$	± 12	± 13.5	-	V
Input Common Mode Voltage Range	V_{ICM}		± 12	± 13.5	-	V
Common Mode Rejection Ratio	CMR	$R_s \leq 10k\Omega$	80	110	-	dB
Supply Voltage Rejection Ratio	SVR	$R_s \leq 10k\Omega$	80	110	-	dB
Operating Current	I_{CC}		-	6	9	mA
Slew Rate	SR	$R_L \geq 2k\Omega$	-	5	-	V/ μs
Gain Bandwidth Product	GB	$f = 10kHz$	-	10	-	MHz
Total Harmonic Distortion	THD	$A_v = 20dB, V_o = 5V, R_L = 2k\Omega, f = 1kHz$	-	0.0005	-	%
Input Noise Voltage	V_{NI}	RIAA, $R_s = 2.2k\Omega, 30kHz$ LPF	-	0.8	-	μV_{rms}

■ TYPICAL CHARACTERISTICS

Maximum Output Voltage Swing vs. Load Resistance

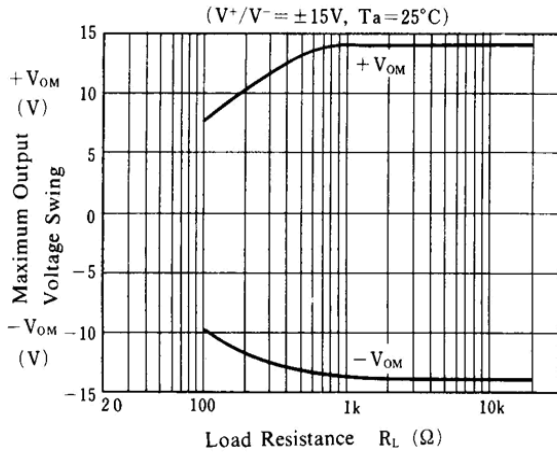

Maximum Output Voltage Swing vs. Frequency

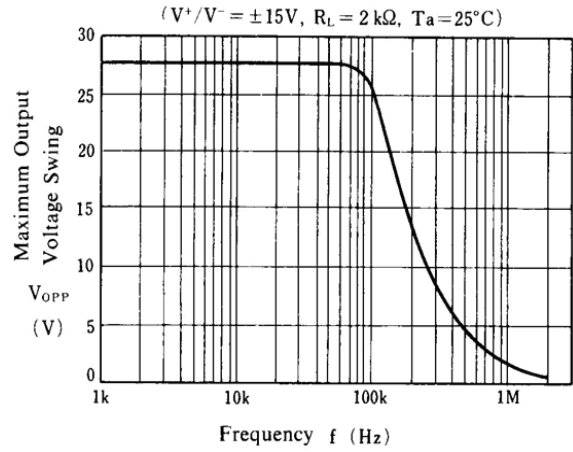

Output Voltage Swing vs. Output Current

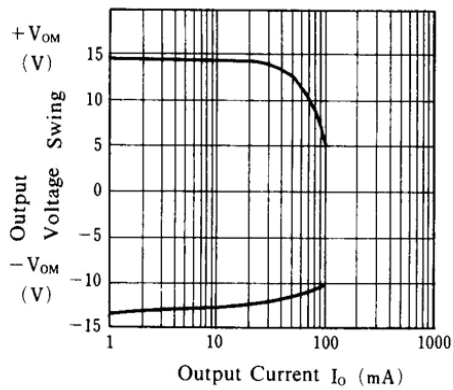

Equivalent Input Noise Voltage vs. Frequency

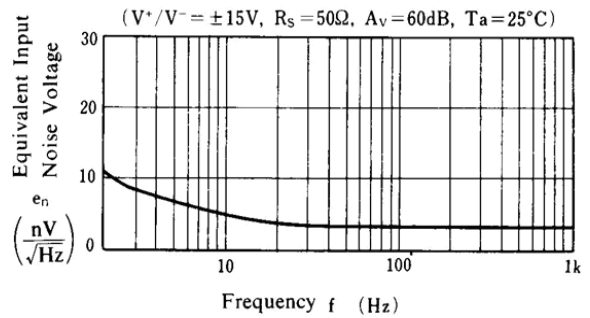

Operating Current vs. Temperature

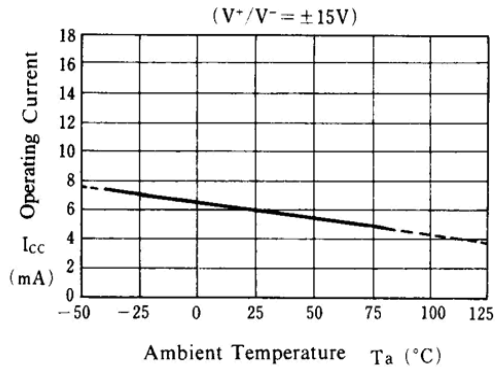

Output Voltage Swing vs. Temperature

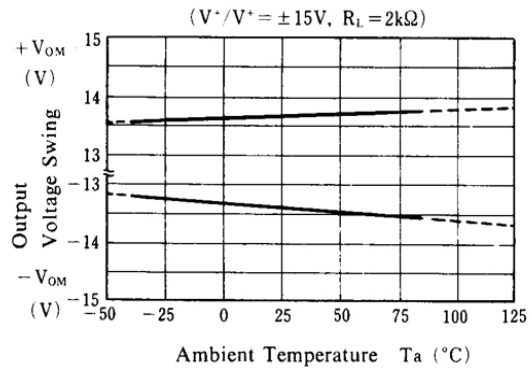

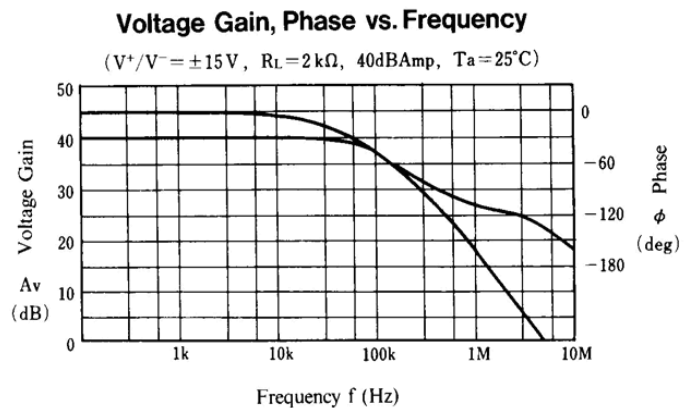
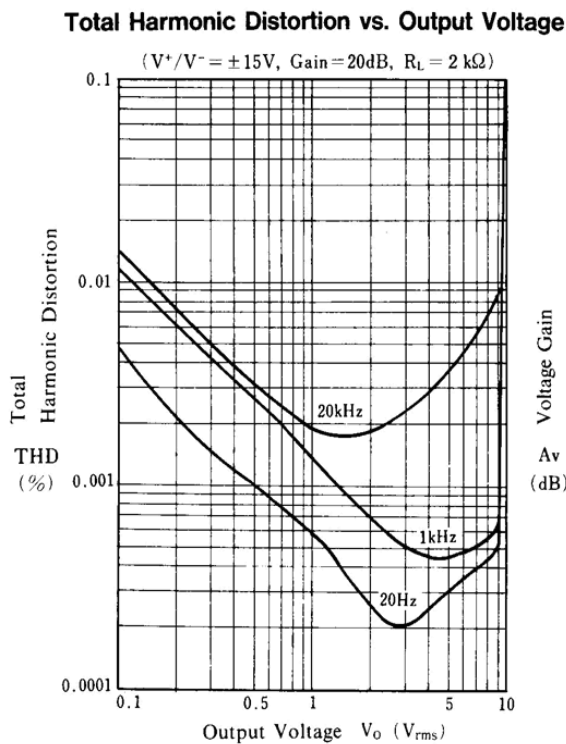
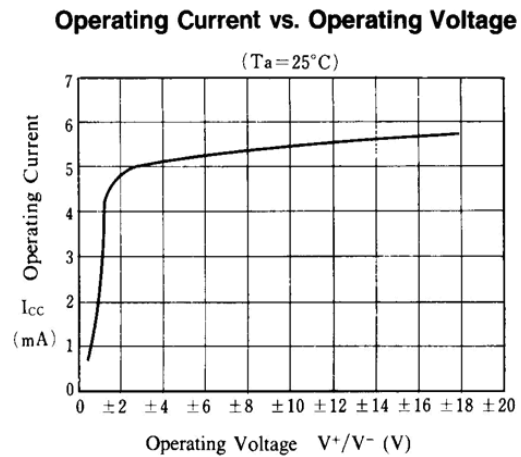
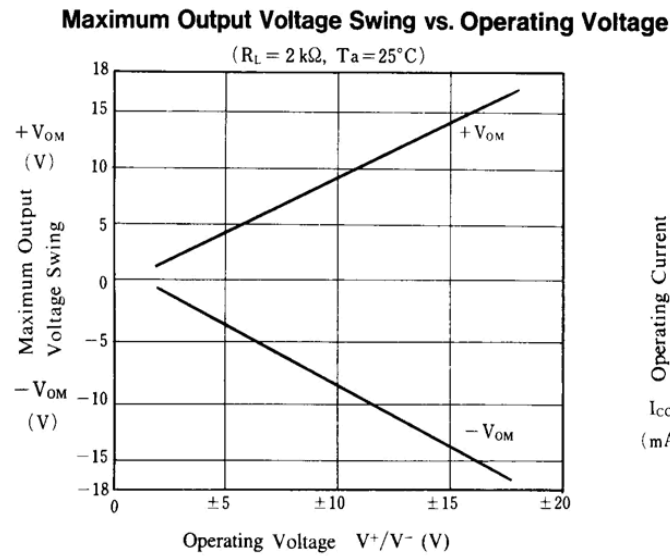
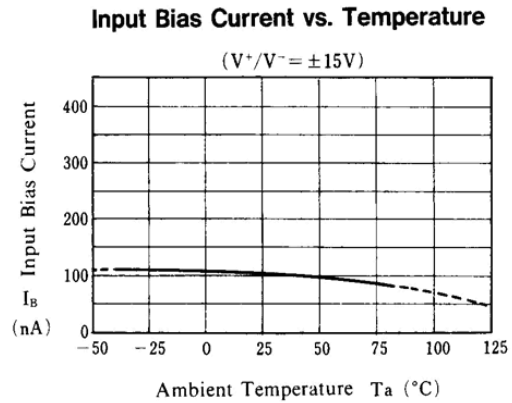
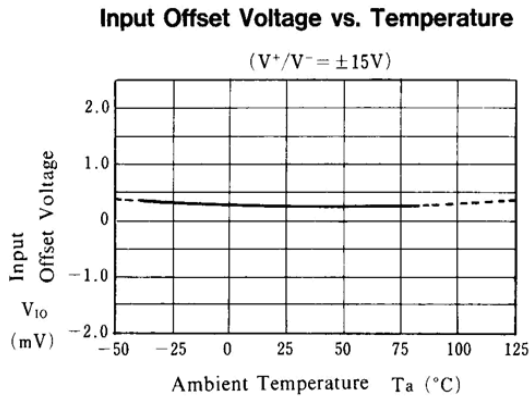
■ TYPICAL CHARACTERISTICS

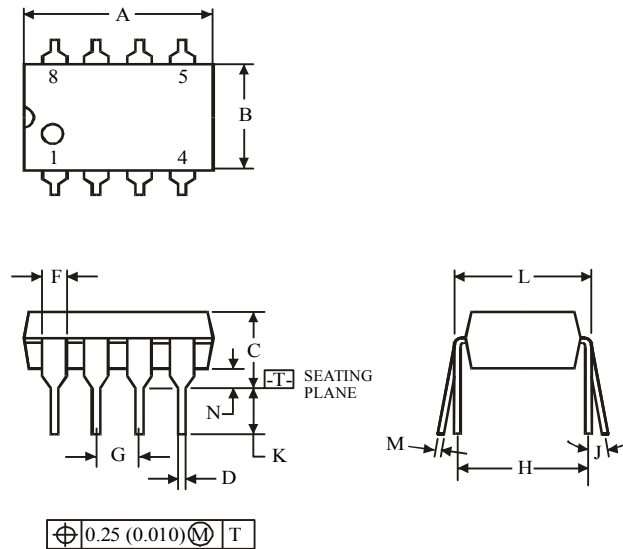
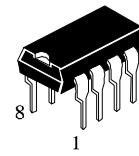
(DIP8)

Symbol	Dimension, mm	
	MIN	MAX
A	8.51	10.16
B	6.1	7.11
C		5.33
D	0.36	0.56
F	1.14	1.78
G	2.54	
H	7.62	
J	0°	10°
K	2.92	3.81
L	7.62	8.26
M	0.2	0.36
N	0.38	

NOTES:

- Dimensions "A", "B" do not include mold flash or protrusions.
Maximum mold flash or protrusions 0.25 mm (0.010) per side.

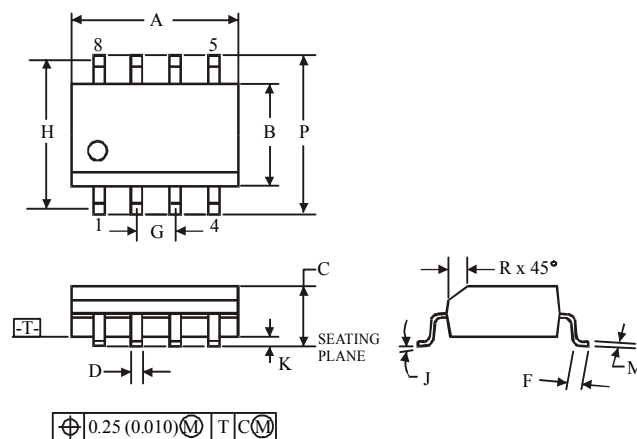
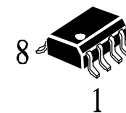
(SOP8)

Symbol	Dimension, mm	
	MIN	MAX
A	4.8	5
B	3.8	4
C	1.35	1.75
D	0.33	0.51
F	0.4	1.27
G	1.27	
H	5.72	
J	0°	8°
K	0.1	0.25
M	0.19	0.25
P	5.8	6.2
R	0.25	0.5

NOTES:

- Dimensions A and B do not include mold flash or protrusion.
- Maximum mold flash or protrusion 0.15 mm (0.006) per side for A; for B - 0.25 mm (0.010) per side.

(MSOP8)

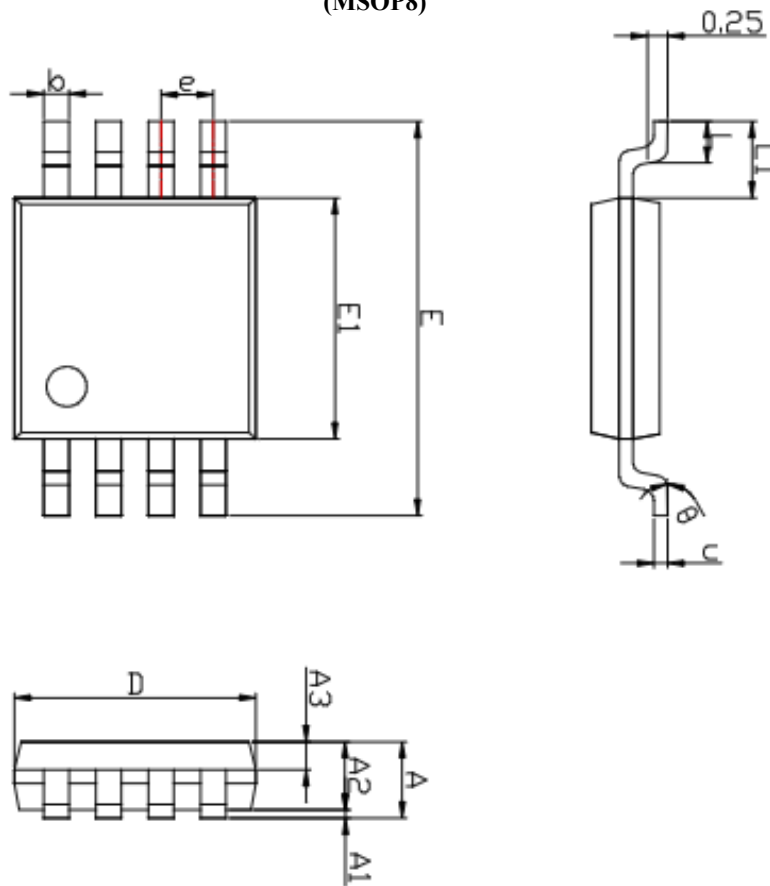

Symbol	MILLIMETER		
	MIN	NOM	MAX
A	—	—	1.10
A1	0.05	0.10	0.15
A2	0.80	0.85	0.90
A3	0.30	0.35	0.40
b	0.27	0.30	0.33
c	0.13	0.15	0.17
D	2.90	3.00	3.10
E	4.70	4.90	5.10
E1	2.90	3.00	3.10
e	0.65BSC		
L	0.40	0.55	0.70
L1	0.90	0.95	1.00
θ	0°	—	8°

X-ON Electronics

Largest Supplier of Electrical and Electronic Components

Click to view similar products for [Operational Amplifiers - Op Amps](#) category:

Click to view products by [HTCSEMI](#) manufacturer:

Other Similar products are found below :

[430227FB](#) [UPC451G2-A](#) [UPC824G2-A](#) [LT1678IS8](#) [UPC258G2-A](#) [NCV33202DMR2G](#) [NJM324E](#) [NTE925](#) [AZV358MTR-G1](#)
[AP4310AUMTR-AG1](#) [AZV358MMTR-G1](#) [SCY33178DR2G](#) [NCV5652MUTWG](#) [NCV20034DR2G](#) [NTE778S](#) [NTE871](#) [NTE937](#)
[MCP6V16UT-E/OT](#) [SCY6358ADR2G](#) [UPC4570G2-E1-A](#) [NCS20282FCTTAG](#) [UPC834G2-E1-A](#) [UPC1458G2-E2-A](#) [UPC813G2-E2-A](#)
[UPC458G2-E1-A](#) [UPC824G2-E2-A](#) [UPC4574G2-E2-A](#) [UPC4558G2-E2-A](#) [UPC4560G2-E1-A](#) [UPC258G2-E1-A](#) [UPC4742GR-9LG-E1-A](#)
[UPC4742G2-E1-A](#) [UPC832G2-E2-A](#) [UPC842G2-E1-A](#) [UPC802G2-E1-A](#) [UPC4741G2-E2-A](#) [UPC4572G2-E2-A](#) [UPC844GR-9LG-E2-A](#)
[UPC259G2-E1-A](#) [UPC4741G2-E1-A](#) [UPC4558G2-E1-A](#) [UPC1251GR-9LG-E1-A](#) [UPC4744G2-E1-A](#) [UPC4092G2-E1-A](#) [UPC4574G2-E1-A](#)
[UPC4062G2-E2-A](#) [UPC451G2-E2-A](#) [UPC832G2-E1-A](#) [UPC844GR-9LG-E1-A](#) [UPC4744G2-E2-A](#)