

## *Low-Power, Rail-to-Rail Output, 12-Bit Serial Input DIGITAL-TO-ANALOG CONVERTER*

The HT7312A is a low-power, single, 12-bit buffered voltage output Digital-to-Analog Converter (DAC). Its on-chip precision output amplifier allows rail-to-rail output swing to be achieved. The HT7312A uses a versatile three-wire serial interface that operates at clock rates up to 30MHz and is compatible with standard SPI™, QSPI™, Microwire™, and DSP interfaces.

The reference for the HT7312A is derived from the power supply, resulting in the widest dynamic output range possible. The HT7312A incorporates a power-on reset circuit that ensures that the DAC output powers up at 0V and remains there until a valid write takes place in the device. The HT7312A contains a power-down feature, accessed over the serial interface, that can reduce the current consumption of the device to 50nA at 5V.

The low power consumption of this part in normal operation makes it ideally suited to portable battery-operated equipment. The power consumption is 0.7mW at 5V reducing to 1μW in power-down mode.

### FEATURES

- **micro POWER OPERATION:** 135μA at 5V
- **POWER -DOWN:** 200nA at 5V, 50nA at 3V
- **POWER SUPPLY:** +2.7V to +5.5V
- **TESTED MONOTONIC BY DESIGN**
- **POWER -ON RESET TO 0V**
- **THREE POWER -DOWN FUNCTIONS**
- **LOW POWER SERIAL INTERFACE WITH SCHMITT -TRIGGERED INPUTS**
- **ON-CHIP OUTPUT BUFFER AMPLIFIER, RAIL -TO -RAIL OPERATION**
- **SYNC INTERRUPT FACILITY**

### APPLICATIONS

- **PORTABLE BATTERY -POWERED INSTRUMENTS**
- **DIGITAL GAIN AND OFFSET ADJUSTMENT**
- **PROGRAMMABLE VOLTAGE AND CURRENT SOURCES**

**ORDERING INFORMATION**

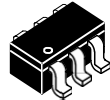

**SOT23-6 T  
SUFFIX  
HT7312ARTZ**

$T_A = -40^\circ$  to  $125^\circ\text{C}$  for all packages.

### Typical Application Circuit

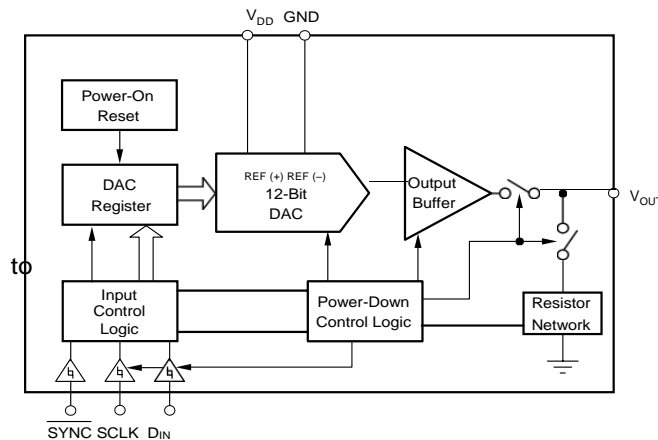

### PIN CONFIGURATIONS

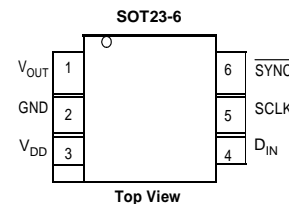



**ABSOLUTE MAXIMUM RATINGS<sup>(1)</sup>**

V <sub>DD</sub> to GND .....	-0.3V to +0.6V
Digital Input Voltage to GND .....	-0.3V to +V <sub>DD</sub> +0.3V
V <sub>OUT</sub> to GND .....	-0.3V to +V <sub>DD</sub> +0.3V
Operating Temperature Range .....	-40°C to +105°C
Storage Temperature Range .....	-65°C to +150°C
Junction Temperature Range (T <sub>J</sub> max) .....	+150°C
SOT23 Package:	
Power Dissipation .....	(T <sub>J</sub> max - T <sub>A</sub> )/J <sub>A</sub>
J <sub>A</sub> Thermal Impedance .....	240°C/W
Lead Temperature, Soldering:	
Vapor Phase(60s).....	+215°C
Infrared (15s) .....	+220°C
MSOP Package:	
Power Dissipation .....	(T <sub>J</sub> max - T <sub>A</sub> )/J <sub>A</sub>
J <sub>A</sub> Thermal Impedance .....	206°C/W
J <sub>C</sub> Thermal Impedance .....	44°C/W
Lead Temperature, Soldering:	
Vapor Phase(60s).....	+215°C
Infrared (15s) .....	+220°C

NOTE: (1) Stresses above those listed under "Absolute Maximum Ratings" may cause permanent damage to the device. Exposure to absolute maximum conditions for extended periods may affect device reliability.

**PIN DESCRIPTION (SOT23-6)**

PIN	NAME	DESCRIPTION
1	V <sub>OUT</sub>	Analog output voltage from DAC. The output amplifier has rail-to-rail operation.
2	GND	Ground reference point for all circuitry on the part.
3	V <sub>DD</sub>	Power Supply Input, +2.7V to 5.5V.
4	D <sub>IN</sub>	Serial Data Input. Data is clocked into the 16-bit input shift register on the falling edge of the serial clock input.
5	SCLK	Serial Clock Input. Data can be transferred at rates up to 30MHz.
6	SYNC	Level triggered control input (active LOW). This is the frame synchronization signal for the input data. When SYNC goes LOW, it enables the input shift register and data is transferred in on the falling edges of the following clocks. The DAC is updated following the 16th clock cycle unless SYNC is taken HIGH before this edge, in which case the rising edge of SYNC acts as an interrupt and the write sequence is ignored by the HT7312A.



PARAMETER	CONDITIONS	HT7312A			UNITS
		MIN	TYP	MAX	
<b>STATIC PERFORMANCE <sup>(1)</sup></b>					
Resolution		12			Bits
Relative Accuracy				±8	LSB
Differential Nonlinearity	Tested Monotonic by Design			±1	LSB
Zero Code Error	All Zeroes Loaded to DAC Register		+5	+20	mV
Full-Scale Error	All Ones Loaded to DAC Register		-0.15	-1.25	% of FSR
Gain Error				±1.25	% of FSR
Zero Code Error Drift			-20		µV/°C
Gain Temperature Coefficient			-5		ppm of FSR/°C
<b>OUTPUT CHARACTERISTICS <sup>(2)</sup></b>					
Output Voltage Range		0		V <sub>DD</sub>	V
Output Voltage Settling Time	1/4 Scale to 3/4 Scale Change (400 <sub>H</sub> to C00 <sub>H</sub> ) R <sub>L</sub> =2kΩ; 0pF < C <sub>L</sub> < 200pF R <sub>L</sub> =2kΩ; C <sub>L</sub> =500pF		8	10	µs
Slew Rate		1	12		µs V/µs
Capacitive Load Stability	R <sub>L</sub> = x R <sub>L</sub> = 2kΩ		470 1000		pF pF
Code Change Glitch Impulse	1LSB Change Around Major Carry		20		nV-s
Digital Feedthrough			0.5		nV-s
DC Output Impedance			1		Ω
Short-Circuit Current	V <sub>DD</sub> = +5V V <sub>DD</sub> = +3V		50 20		mA mA
Power-Up Time	Coming Out of Power-Down Mode V <sub>DD</sub> = +5V Coming Out of Power-Down Mode V <sub>DD</sub> = +3V		2.5 5		µs µs
<b>LOGIC INPUTS <sup>(2)</sup></b>					
Input Current				±1	µA
V <sub>INL</sub> , Input Low Voltage	V <sub>DD</sub> = +5V			0.8	V
V <sub>INL</sub> , Input Low Voltage	V <sub>DD</sub> = +3V			0.6	V
V <sub>INH</sub> , Input High Voltage	V <sub>DD</sub> = +5V	2.4			V
V <sub>INH</sub> , Input High Voltage	V <sub>DD</sub> = +3V	2.1			V
Pin Capacitance				3	pF
<b>POWER REQUIREMENTS</b>					
V <sub>DD</sub>		2.7		5.5	V
I <sub>DD</sub> (normal mode)	DAC Active and Excluding Load Current				
V <sub>DD</sub> = +3.6V to +5.5V	V <sub>IH</sub> = V <sub>DD</sub> and V <sub>IL</sub> = GND		135	200	µA
V <sub>DD</sub> = +2.7V to +3.6V	V <sub>IH</sub> = V <sub>DD</sub> and V <sub>IL</sub> = GND		115	160	µA
I <sub>DD</sub> (all power-down modes)					
V <sub>DD</sub> = +3.6V to +5.5V	V <sub>IH</sub> = V <sub>DD</sub> and V <sub>IL</sub> = GND		0.2	1	µA
V <sub>DD</sub> = +2.7V to +3.6V	V <sub>IH</sub> = V <sub>DD</sub> and V <sub>IL</sub> = GND		0.05	1	µA
<b>POWER EFFICIENCY</b>					
I <sub>OUT</sub> /I <sub>DD</sub>	I <sub>LOAD</sub> = 2mA. V <sub>DD</sub> = +5V		93		%
<b>TEMPERATURE RANGE</b>					
Specified Performance		-40		+105	°C

NOTES: (1) Linearity calculated using a reduced code range of 48 to 4047; output unloaded. (2) Guaranteed by design and characterization, not production tested.

## TIMING CHARACTERISTICS(1, 2)

$V_{DD} = +2.7V$  to  $+5.5V$ ; all specifications  $-40^{\circ}C$  to  $+105^{\circ}C$ , unless otherwise noted.

HT7312A						
PARAMETER	DESCRIPTION	CONDITIONS	MIN	TYP		
MAX	UNITS t <sup>(3)</sup>	SCLK Cycle Time	$V_{DD} = 2.7V$ to $3.6V$	50		ns
			$V_{DD} = 3.6V$ to $5.5V$	33		ns
t <sub>2</sub>	SCLK HIGH Time	$V_{DD} = 2.7V$ to $3.6V$	13		ns	
t <sub>3</sub>	SCLK LOW Time	$V_{DD} = 3.6V$ to $5.5V$	13		ns	
t <sub>4</sub>	SYNC to SCLK Rising Edge Setup Time	$V_{DD} = 2.7V$ to $3.6V$	22.5		ns	
		$V_{DD} = 3.6V$ to $5.5V$	13		ns	
t <sub>5</sub>	Data Setup Time	$V_{DD} = 2.7V$ to $3.6V$	0		ns	
		$V_{DD} = 3.6V$ to $5.5V$	0		ns	
t <sub>6</sub>	Data Hold Time	$V_{DD} = 2.7V$ to $3.6V$	5		ns	
		$V_{DD} = 3.6V$ to $5.5V$	5		ns	
t <sub>7</sub>	SCLK Falling Edge to SYNC Rising Edge	$V_{DD} = 2.7V$ to $3.6V$	4.5		ns	
		$V_{DD} = 3.6V$ to $5.5V$	4.5		ns	
t <sub>8</sub>	Minimum SYNC HIGH Time	$V_{DD} = 2.7V$ to $3.6V$	0		ns	
		$V_{DD} = 3.6V$ to $5.5V$	0		ns	
		$V_{DD} = 2.7V$ to $3.6V$	50		ns	
		$V_{DD} = 3.6V$ to $5.5V$	33		ns	

NOTES: (1) All input signals are specified with  $t_R = t_F = 5ns$  (10% to 90% of  $V_{DD}$ ) and timed from a voltage level of  $(V_{IL} + V_{IH})/2$ . (2) See Serial Write Operation timing diagram, below. (3) Maximum SCLK frequency is 30MHz at  $V_{DD} = +3.6V$  to  $+5.5V$  and 20MHz at  $V_{DD} = +2.7V$  to  $+3.6V$ .

### SERIAL WRITE OPERATION

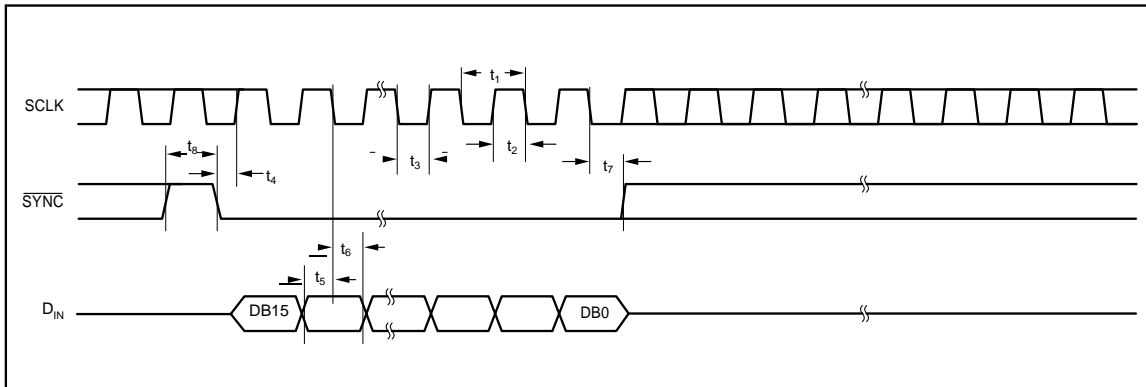

**TYPICAL CHARACTERISTICS:  $V_{DD} = +5V$** 

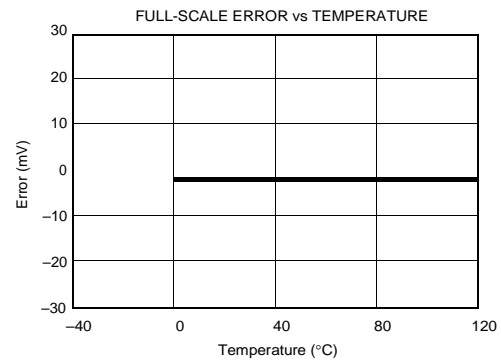
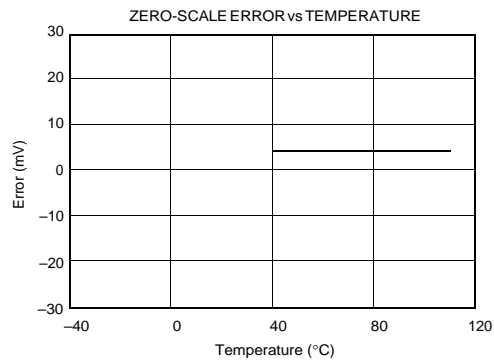
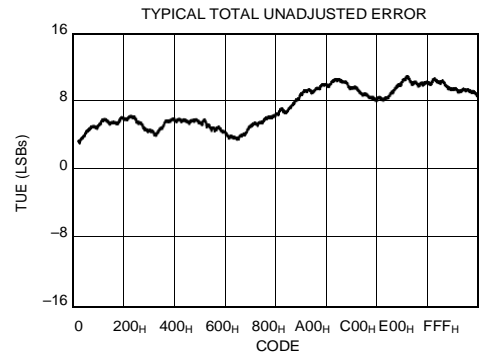
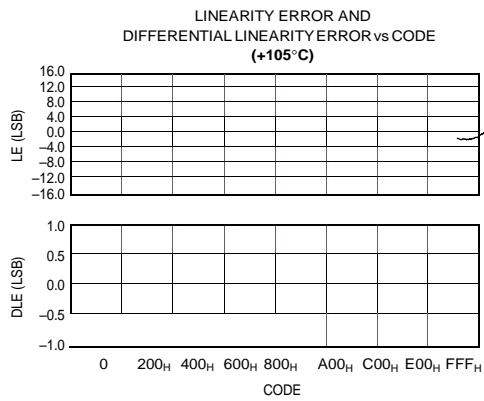
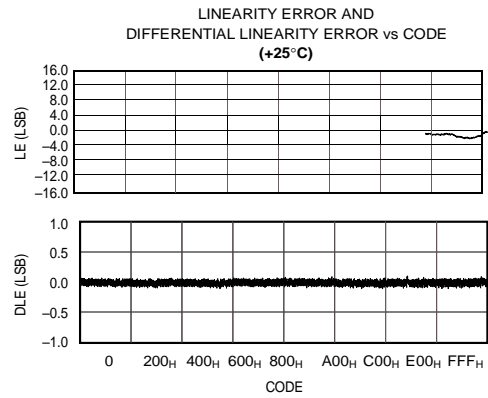
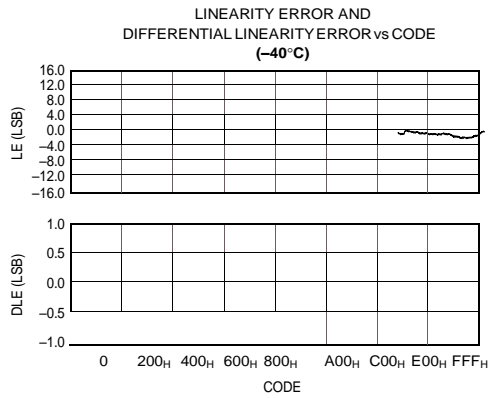
 At  $T_A = +25^\circ\text{C}$ ,  $V_{DD} = +5V$ , unless otherwise noted.

## TYPICAL CHARACTERISTICS: $V_{DD} = +5V$ (Cont.)

At  $T_A = +25^\circ\text{C}$ ,  $+V_{DD} = +5V$ , unless otherwise noted.

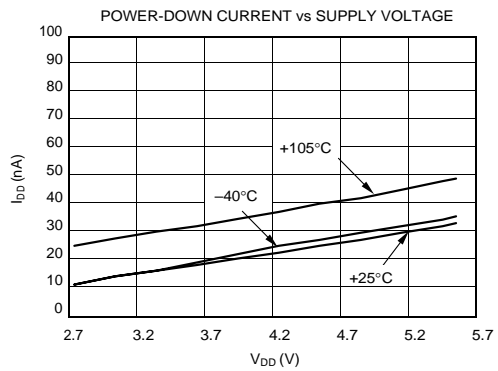
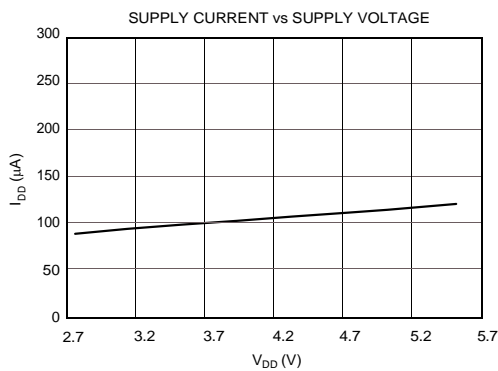
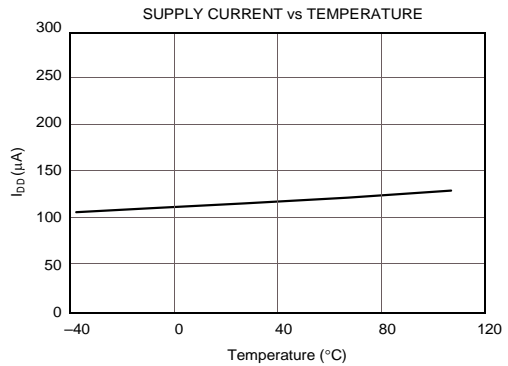
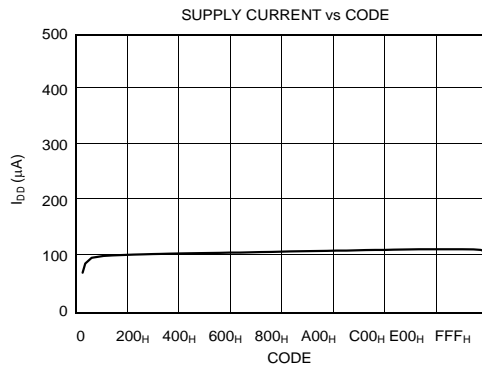
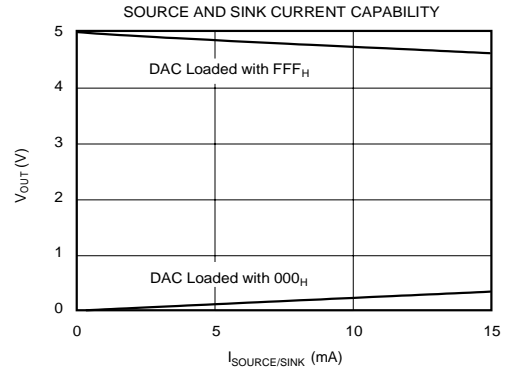
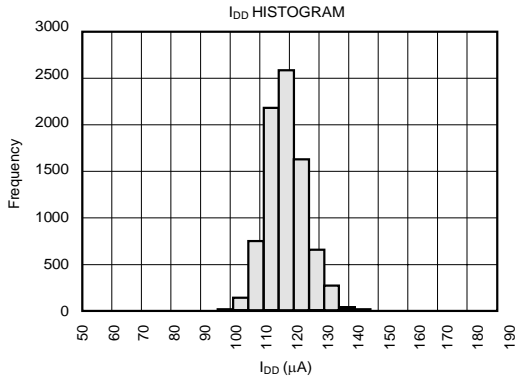

## TYPICAL CHARACTERISTICS: $V_{DD} = +5V$ (Cont.)

At  $T_A = +25^\circ\text{C}$ ,  $+V_{DD} = +5V$ , unless otherwise noted.

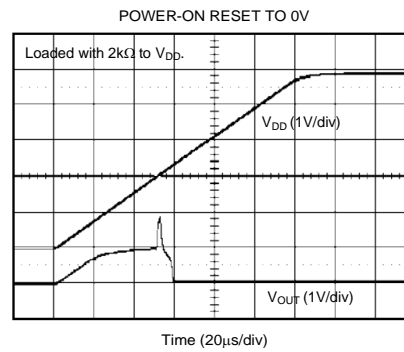
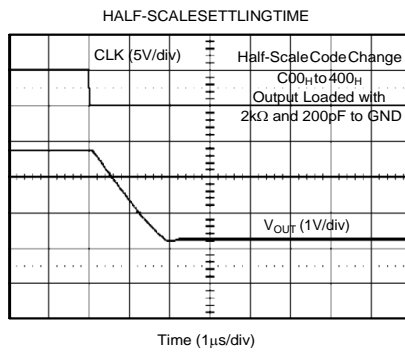
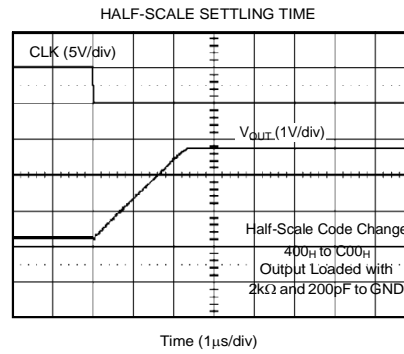
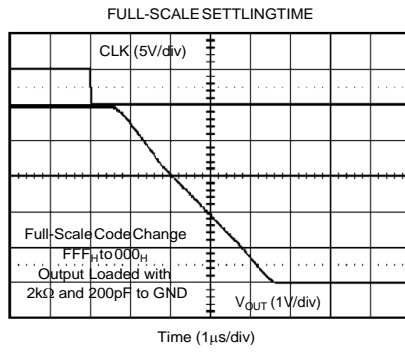
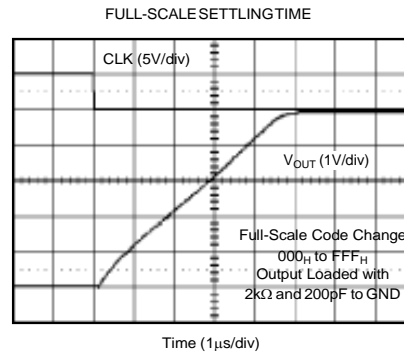
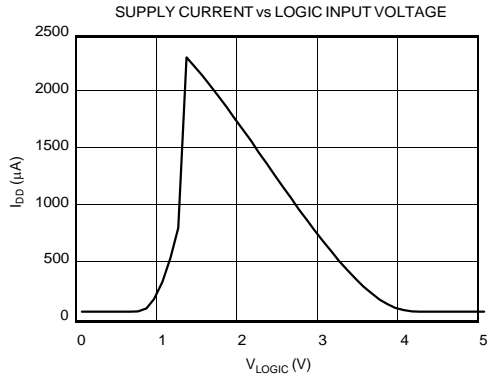

### TYPICAL CHARACTERISTICS: $V_{DD} = +5V$ (Cont.)

At  $T_A = +25^\circ C$ ,  $V_{DD} = +5V$ , unless otherwise noted.

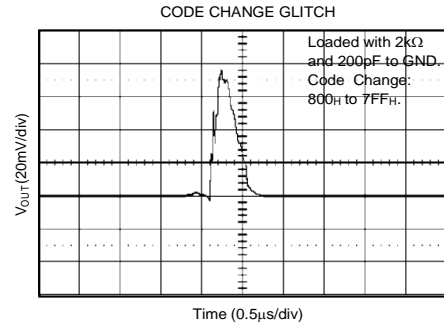
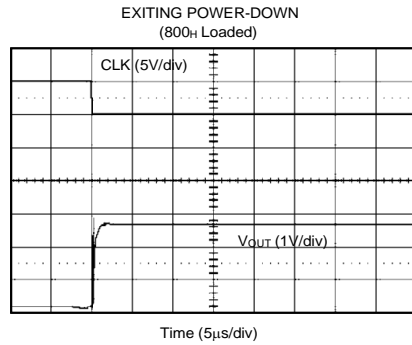

### TYPICAL CHARACTERISTICS: $V_{DD} = +2.7V$

At  $T_A = +25^\circ C$ ,  $V_{DD} = +2.7V$ , unless otherwise noted.

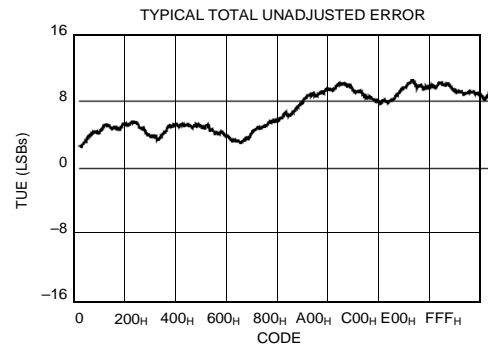
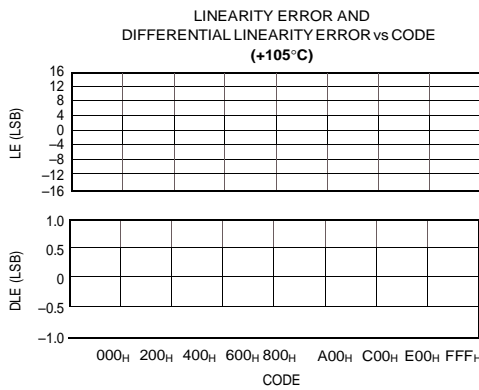
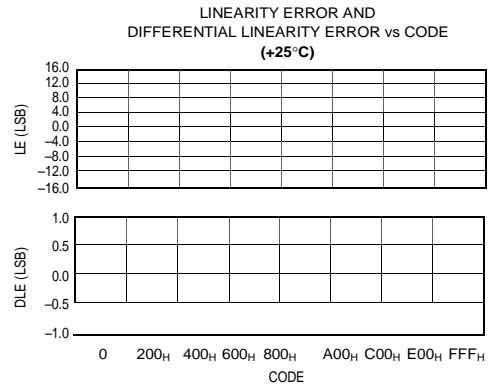
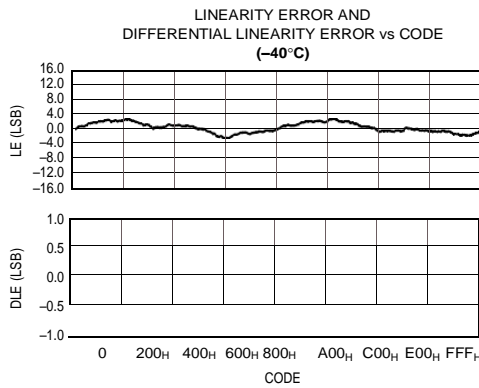



**TYPICAL CHARACTERISTICS:  $V_{DD} = +2.7V$  (Cont.)**

At  $T_A = +25^\circ C$ ,  $+V_{DD} = +2.7V$ , unless otherwise noted.

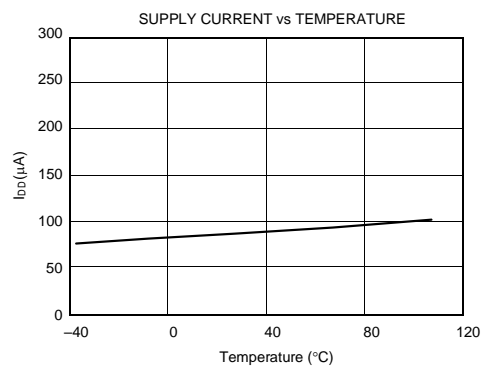
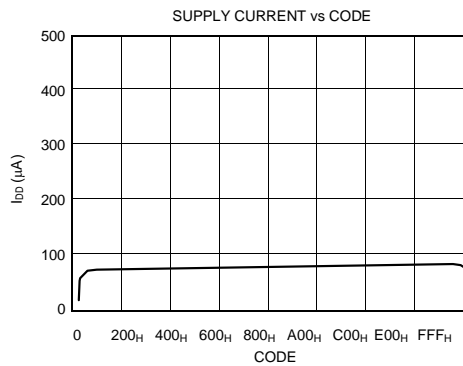
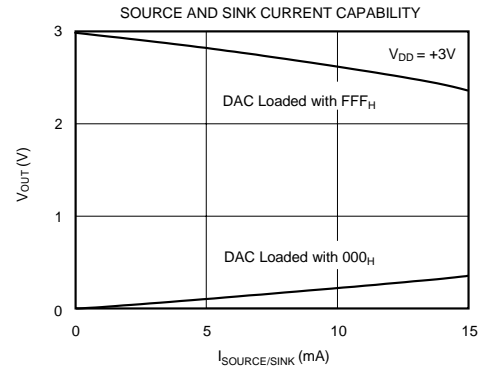
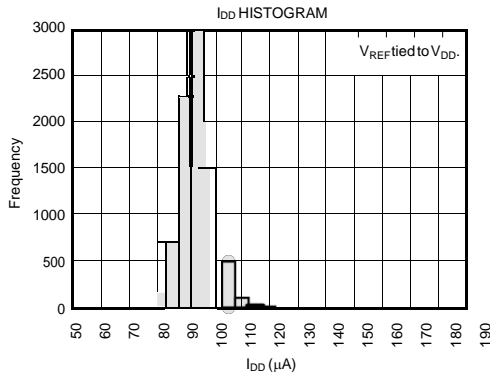
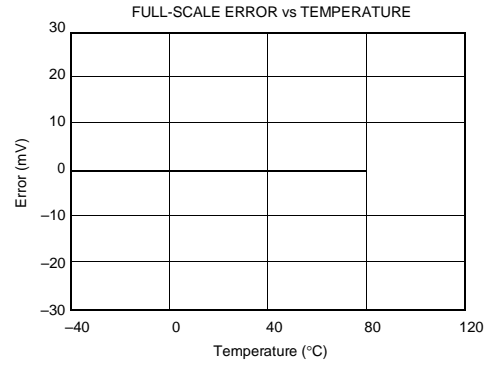
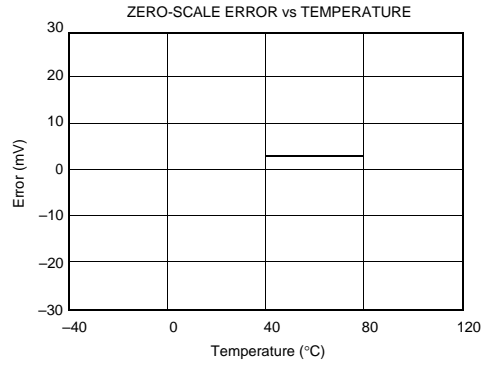

## TYPICAL CHARACTERISTICS: $V_{DD} = +2.7V$ (Cont.)

At  $T_A = +25^\circ C$ ,  $+V_{DD} = +2.7V$ , unless otherwise noted.

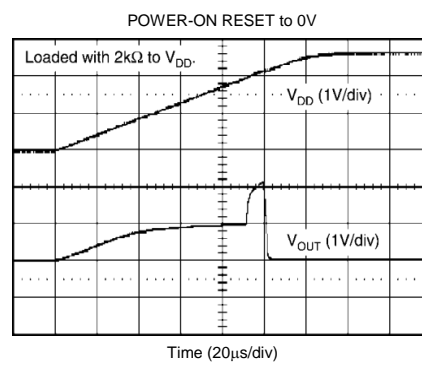
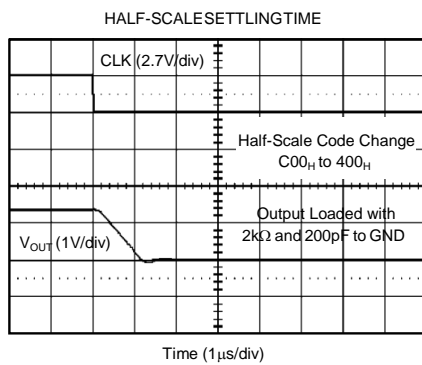
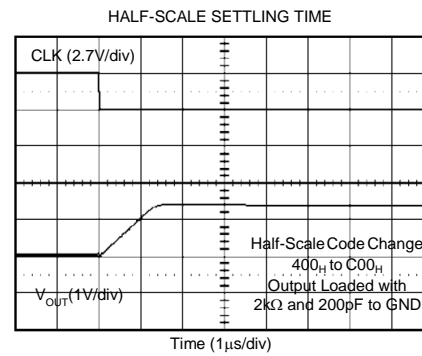
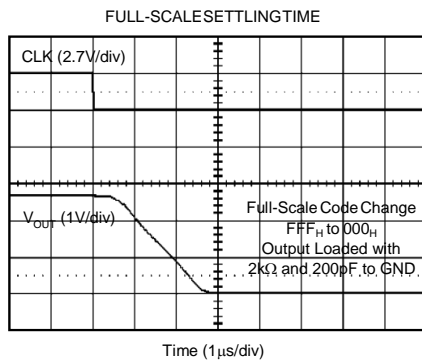
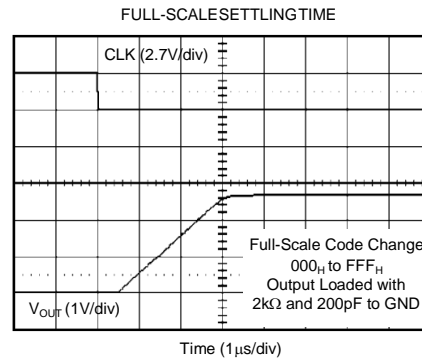
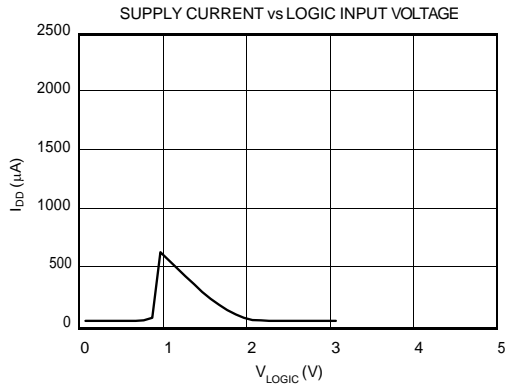



## TYPICAL CHARACTERISTICS: $V_{DD} = +2.7V$ (Cont.)

At  $T_A = +25^\circ C$ ,  $+V_{DD} = +2.7V$ , unless otherwise noted.

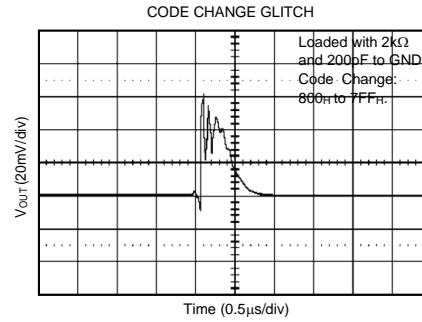
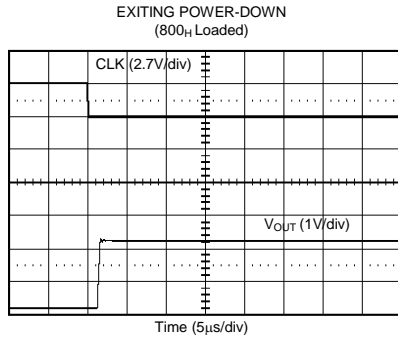

## THEORY OF OPERATION

### DAC SECTION

The HT7312A is fabricated using a CMOS process. The architecture consists of a string DAC followed by an output buffer amplifier. Since there is no reference input pin, the power supply ( $V_{DD}$ ) acts as the reference. Figure 1 shows a block diagram of the DAC architecture.

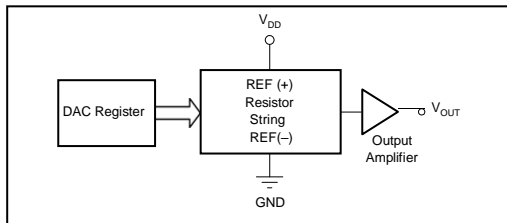

FIGURE 1. HT7312A Architecture.

The input coding to the HT7312A is straight binary, so the ideal output voltage is given by:

$$V_{OUT} = V_{DD} \frac{D}{4096}$$

where  $D$  = decimal equivalent of the binary code that is loaded to the DAC register; it can range from 0 to 4095.

### RESISTOR STRING

The resistor string section is shown in Figure 2. It is simply a string of resistors, each of value  $R$ . The code loaded into the DAC register determines at which node on the string the voltage is tapped off to be fed into the output amplifier by closing one of the switches connecting the string to the amplifier. It is tested monotonic because it is a string of resistors.

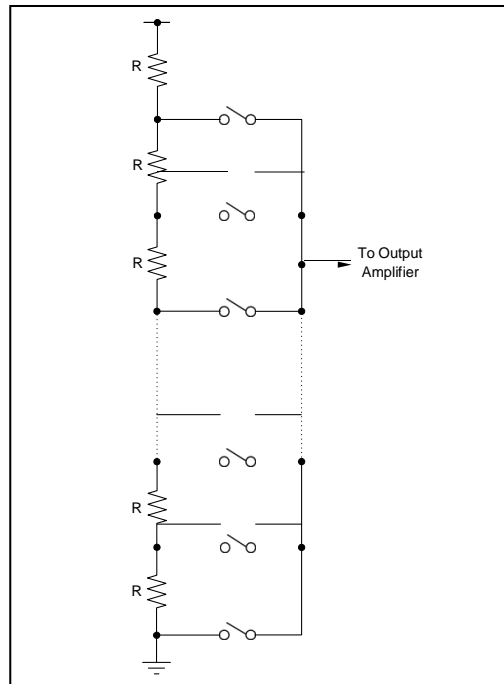

FIGURE 2. Resistor String.

### OUTPUT AMPLIFIER

The output buffer amplifier is capable of generating rail-to-rail voltages on its output which gives an output range of 0V to  $V_{DD}$ . It is capable of driving a load of 2kΩ in parallel with 1000pF to GND. The source and sink capabilities of the output amplifier can be seen in the typical characteristics. The slew rate is 1V/µs with a half-scale settling time of 8µs with the output unloaded.

## SERIAL INTERFACE

The HT7312A has a three-wire serial interface (SYNC, SCLK, and D<sub>IN</sub>), which is compatible with SPI, QSPI, and Microwire interface standards as well as most Digital Signal Processors (DSPs). See the Serial Write Operation timing diagram for an example of a typical write sequence.

The write sequence begins by bringing the SYNC line LOW. Data from the D<sub>IN</sub> line is clocked into the 16-bit shift register on the falling edge of SCLK. The serial clock frequency can be as high as 30MHz, making the HT7312A compatible with high-speed DSPs. On the 16th falling edge of the serial clock, the last data bit is clocked in and the programmed function is executed (i.e., a change in DAC register contents and/or a change in the mode of operation).

At this point, the SYNC line may be kept LOW or brought HIGH. In either case, it must be brought HIGH for a minimum of 33ns before the next write sequence so that a falling edge of SYNC can initiate the next write sequence. Since the SYNC buffer draws more current when the SYNC signal is HIGH than it does when it is LOW, SYNC should be idled LOW between write sequences for lowest power operation of the part. As mentioned above, however, it must be brought HIGH again just before the next write sequence.

### INPUT SHIFT REGISTER

The input shift register is 16 bits wide, as shown in Figure 3. The first two bits are "don't cares". The next two bits (PD1 and PD0) are control bits that control which mode of operation the part is in (normal mode or one of three power-down modes). There is a more complete description of the various modes in the Power-Down Modes section. The next 12 bits are the data bits. These are transferred to the DAC register on the 16th falling edge of SCLK.

### SYNC INTERRUPT

In a normal write sequence, the SYNC line is kept LOW for at least 16 falling edges of SCLK and the DAC is updated on the 16th falling edge. However, if SYNC is brought HIGH before the 16th falling edge, this acts as an interrupt to the

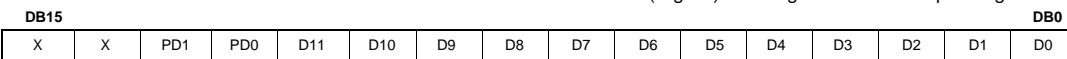

FIGURE 3. Data Input Register.

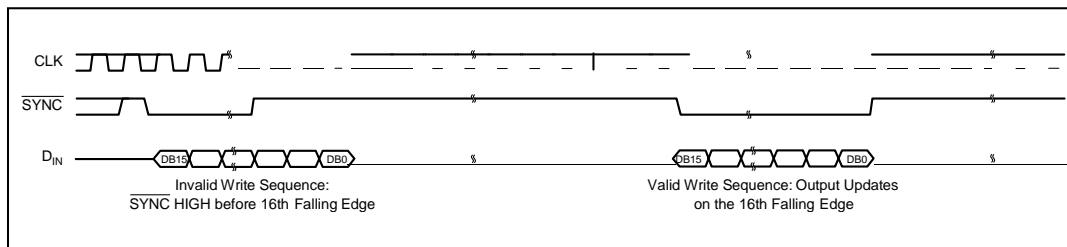

FIGURE 4. SYNC Interrupt Facility.

write sequence. The shift register is reset and the write sequence is seen as invalid. Neither an update of the DAC register contents or a change in the operating mode occurs, as shown in Figure 4.

### POWER-ON RESET

The HT7312A contains a power-on reset circuit that controls the output voltage during power-up. On power-up, the DAC register is filled with zeros and the output voltage is 0V; it remains there until a valid write sequence is made to the DAC. This is useful in applications where it is important to know the state of the output of the DAC while it is in the process of powering up.

### POWER-DOWN MODES

The HT7312A contains four separate modes of operation. These modes are programmable by setting two bits (PD1 and PD0) in the control register. Table I shows how the state of the bits corresponds to the mode of operation of the device.

DB13	DB12	OPERATING MODE
0	0	Normal Operation
0	1	Power-Down Modes: Output 1kΩ to GND
1	0	Output 100kΩ to GND
1	1	High-Z

TABLE I. Modes of Operation for the HT7312A.

When both bits are set to 0, the part works normally with its normal power consumption of 135μA at 5V. However, for the three power-down modes, the supply current falls to 200nA at 5V (50nA at 3V). Not only does the supply current fall, but the output stage is also internally switched from the output of the amplifier to a resistor network of known values. This has the advantage that the output impedance of the part is known while the part is in power-down mode. There are three different options. The output is connected internally to GND through a 1kΩ resistor, a 100kΩ resistor, or it is left open-circuited (High-Z). See Figure 5 for the output stage.

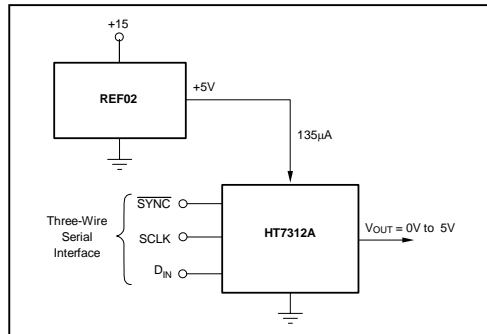

FIGURE 9. REF02 as Power Supply to HT7312A.

is loaded, the REF02 also needs to supply the current to the load. The total current required (with a 5kΩ load on the DAC output) is:

$$135\mu\text{A} + (5\text{V}/5\text{k}\Omega) = 1.14\text{mA}$$

The load regulation of the REF02 is typically 0.005%/mA, which results in an error of 285µV for the 1.14mA current drawn from it. This corresponds to a 0.2LSB error.

#### BIPOLAR OPERATION USING THE HT7312A

The HT7312A has been designed for single-supply operation but a bipolar output range is also possible using the circuit in Figure 10. The circuit shown will give an output voltage range of ±5V. Rail-to-rail operation at the amplifier output is achievable using an OPA340 as the output amplifier.

The output voltage for any input code can be calculated as follows:

$$V_{\text{OUT}} = \left[ \frac{D}{4096} \cdot \left( \frac{R_1 + R_2}{R_1} \right) - V_{\text{DD}} \right] \cdot \left( \frac{R_2}{R_1} \right)$$

where D represents the input code in decimal (0 - 4095).

With  $V_{\text{DD}} = 5\text{V}$ ,  $R_1 = R_2 = 10\text{k}\Omega$ :

$$V_{\text{OUT}} = \left( \frac{10 \cdot D}{4096} \right) - 5\text{V}$$

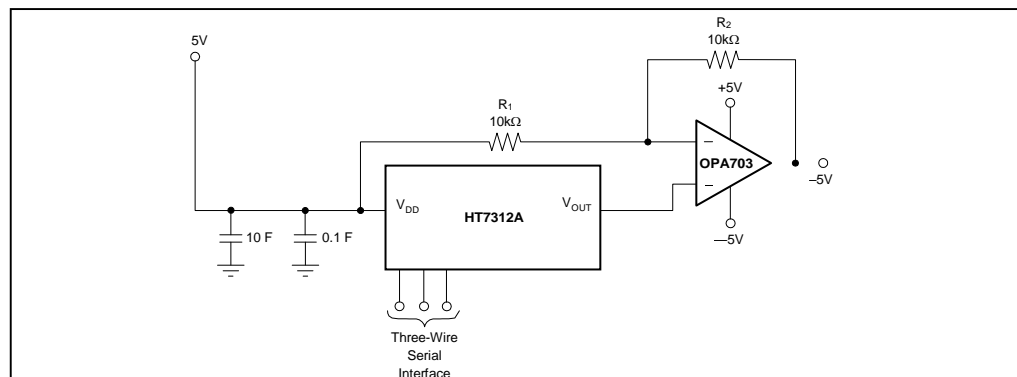

FIGURE 10. Bipolar Operation with the HT7312A.

This is an output voltage range of ±5V with 000H corresponding to a -5V output and FFFH corresponding to a +5V output.

## LAYOUT

A precision analog component requires careful layout, adequate bypassing, and clean, well-regulated power supplies.

As the HT7312A offers single-supply operation, it will often be used in close proximity with digital logic, microcontrollers, microprocessors, and digital signal processors. The more digital logic present in the design and the higher the switching speed, the more difficult it will be to achieve good performance from the converter.

Due to the single ground pin of the HT7312A, all return currents, including digital and analog return currents, must flow through the GND pin. Ideally, GND would be connected directly to an analog ground plane. This plane would be separate from the ground connection for the digital components until they were connected at the power entry point of the system.

The power applied to  $V_{\text{DD}}$  should be well regulated and low noise. Switching power supplies and DC/DC converters will often have high-frequency glitches or spikes riding on the output voltage. In addition, digital components can create similar high-frequency spikes as their internal logic switches states. This noise can easily couple into the DAC output voltage through various paths between the power connections and analog output. This is particularly true for the HT7312A, as the power supply is also the reference voltage for the DAC.

As with the GND connection,  $V_{\text{DD}}$  should be connected to a +5V power supply plane or trace that is separate from the connection for digital logic until they are connected at the power entry point. In addition, the 1µF to 10µF and 0.1µF bypass capacitors are strongly recommended. In some situations, additional bypassing may be required, such as a 100µF electrolytic capacitor or even a "Pi" filter made up of inductors and capacitors—all designed to essentially low-pass filter the +5V supply, removing the high-frequency noise.

**SOT23-6**

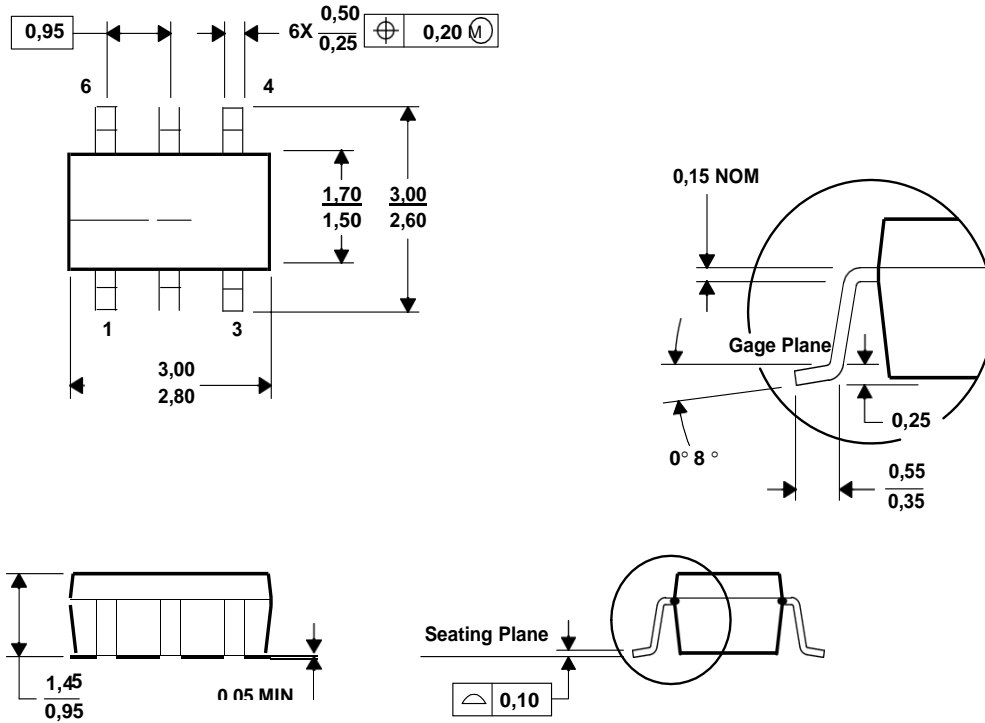

- NOTES: A. All linear dimensions are in millimeters.  
 B. This drawing is subject to change without notice.  
 C. Body dimensions do not include mold flash or protrusion.  
 D. Leads 1, 2, 3 may be wider than leads 4, 5, 6 for package orientation.

## X-ON Electronics

Largest Supplier of Electrical and Electronic Components

*Click to view similar products for [Digital to Analog Converters - DAC category](#):*

*Click to view products by [HTCSEMI manufacturer](#):*

Other Similar products are found below :

[MCP48CVB28-20E/ST](#) [MCP48CVB14-20E/ST](#) [MCP47CMB24-20E/ST](#) [HI5660/6IA](#) [HI5660IB](#) [HI5731BIB](#) [HI5741BIBZ](#) [HI5760BIB](#)  
[HI5860IB](#) [ISL5629IN](#) [ISL5729IN](#) [ISL5857IA](#) [ISL5857IB](#) [ISL5861IB](#) [ISL5927IN](#) [ISL5961IA](#) [TLV5614IDR](#) [GP8313-TC50-EW](#)  
[AD5689RBRUZ-RL7](#) [AD7528JPZ-REEL](#) [GP8413-TC50-EW](#) [GP8512-TC50-SW](#) [GP8311-TC50-EW](#) [GP8312-TC50-EW](#) [GP8202SL-TC50-](#)  
[EW](#) [HGC5615IM/TR](#) [HT8312ARTZ](#) [HT5615ARZ](#) [AD5064BRUZ-1REEL7](#) [AD5664RBRMZ-5REEL7](#) [MCP4725A3T-E/CH](#) [MCP4921-](#)  
[E/MC](#) [DAC8218SPAG](#) [BH2226FV-E2](#) [MAX5885EGM+D](#) [MAX5816ATB+T](#) [MAX5815BAUD+](#) [MAX5548ETE+](#) [MAX5805BATB+T](#)  
[BU2508FV-E2](#) [BH2226F-E2](#) [DAC8554IPWR](#) [DAC7641YB/250](#) [TLV5638CDR](#) [DAC900TPWRQ1](#) [MAX5318GUG+](#) [MAX5705BAUB+](#)  
[MCP4821-EMC](#) [MAX5820MEUA+](#) [DAC8775IRWFT](#)