



MBRF10150CT

Dual High Voltage Schottky Rectifier

●Features:

- Common Cathode Structure
- Low Power Loss and High Efficiency
- Low Forward Voltage Drop
- High Surge Capability

●Application:

- High Frequency Switch
- Free Wheeling, and Polarity Protection Applications

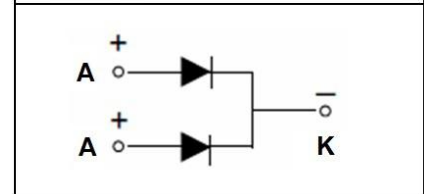
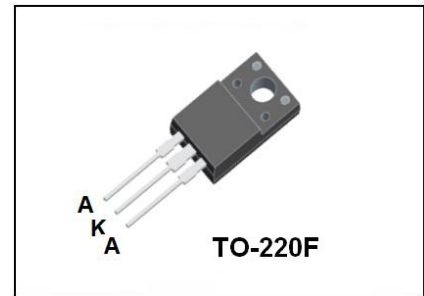

Absolute Maximum Ratings (T_c=25°C unless otherwise noted)

Symbol	Parameter	Value	Unit
V _{RRM}	Maximum Repetitive Reverse Voltage	150	V
V _R	Maximum DC Reverse Voltage	150	V
I _{F(AV)}	Average Rectified Forward Current, T _c =120°C	5(Per Leg) 10(Per Device)	A
I _{FSM}	Peak Forward Surge Current, 8.3ms Half Sine wave	120	A
T _j	Operating Junction Temperature	150	°C
T _{stg}	Storage Temperature Range	-55 to +150	°C

Thermal Characteristics (T_c=25°C unless otherwise noted)

Symbol	Parameter	Max	Unit
R _{θJC}	Thermal Resistance, Junction to Case Per Leg	4.0	°C / W

Electrical Characteristics (T_c=25°C unless otherwise noted)

Symbol	Parameter	Test Conditions	Min	Max	Unit
V _{RRM}	Maximum Repetitive Reverse Voltage	I _R =100μA	150		V
I _R	Reverse Current	V _R = 150V T _c =25°C V _R = 150V T _c =125°C		0.1 5	mA
V _F	Forward Voltage	I _F =5A T _c =25°C I _F =5A T _c =125°C I _F =10A T _c =25°C I _F =10A T _c =125°C		0.92 0.82 1.02 0.92	V

Typical Performance Characteristics

Figure 1. Forward Current Characteristics

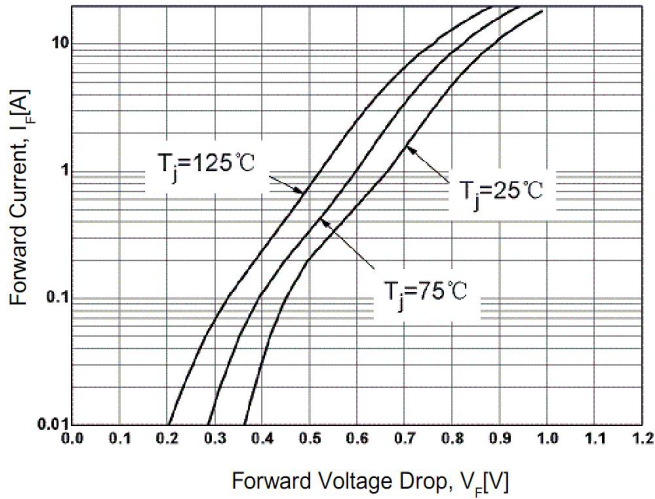

Figure 2. Reverse Leakage Current

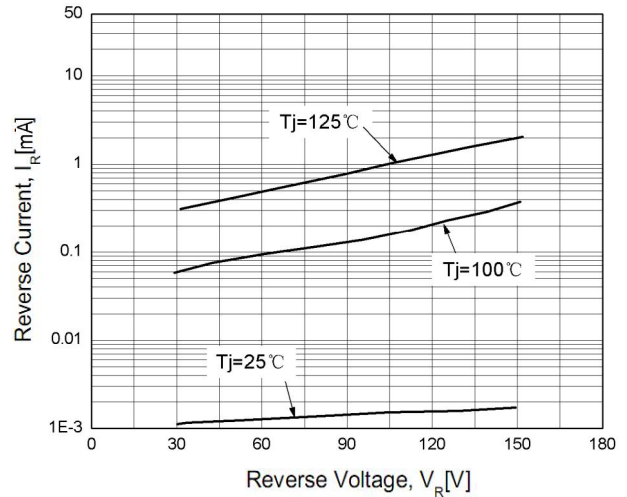

Figure 3. Junction Capacitance

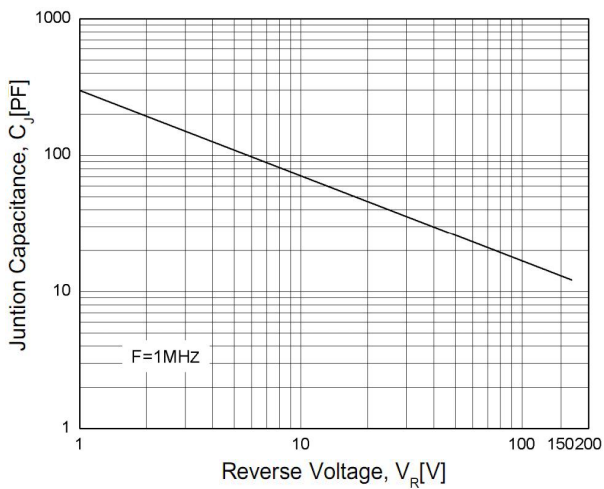
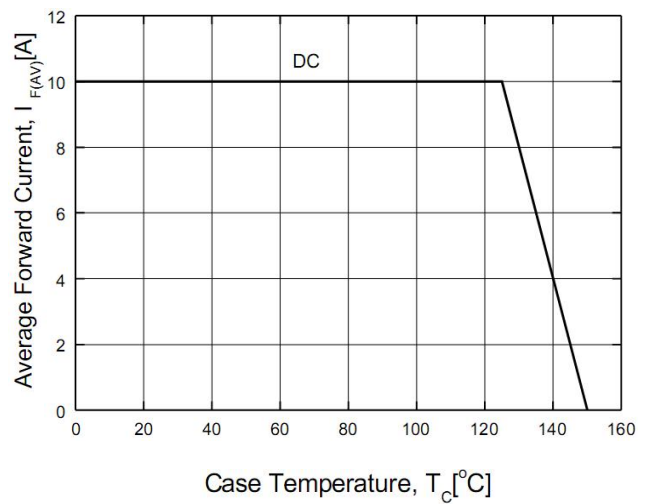

Figure 4. Power Derating



TO-220F Package Dimensions

UNIT: mm

SYMBOL	min	nom	max	SYMBOL	min	nom	max
A	9.80		10.60	D		2.54	
A1		7.00		D1	1.15		1.55
A2	2.90		3.40	D2	0.60		1.00
A3	9.10		9.90	D3	0.20		0.50
B1	15.40		16.40	E	2.24		2.84
B2	4.35		4.95	E1		0.70	
B3	6.00		7.40	E2		1.0×45°	
C	3.00		3.70	E3	0.35		0.65
C1	15.00		17.00	E4	2.30		3.30
C2	8.80		10.80	α (度)		30°	

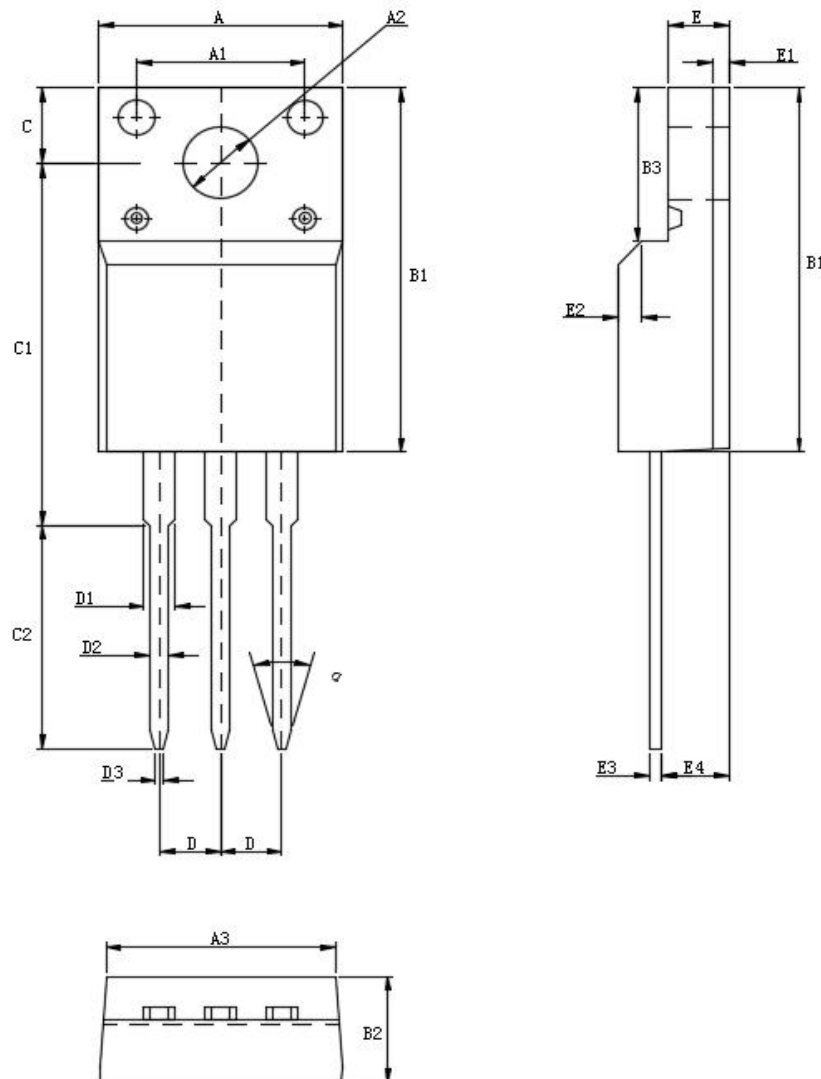

X-ON Electronics

Largest Supplier of Electrical and Electronic Components

Click to view similar products for [Schottky Diodes & Rectifiers](#) category:

Click to view products by [HUAKE](#) manufacturer:

Other Similar products are found below :

[CUS06\(Te85L,Q,M\)](#) [MA4E2039](#) [D1FH3-5063](#) [MBR0530L-TP](#) [MBR10100CT-BP](#) [MBR30H100MFST1G](#) [MMBD301M3T5G](#) [PMAD1103-LF](#) [PMAD1108-LF](#) [RB160M-50TR](#) [RB520S-30](#) [RB551V-30](#) [DD350N18K](#) [DZ435N40K](#) [DZ600N16K](#) [BAS16E6433HTMA1](#) [BAS 3010S-02LRH E6327](#) [BAT 54-02LRH E6327](#) [IDL02G65C5XUMA1](#) [NSR05F40QNXT5G](#) [NSVR05F40NXT5G](#) [JANS1N6640](#) [SB07-03C-TB-H](#) [SB1003M3-TL-W](#) [SBAT54CWT1G](#) [SBM30-03-TR-E](#) [SBS818-TL-E](#) [SK32A-LTP](#) [SK33A-TP](#) [SK34A-TP](#) [SK34B-TP](#) [SMD1200PL-TP](#) [ACDBN160-HF](#) [SS3003CH-TL-E](#) [STPS30S45CW](#) [PDS3100Q-7](#) [GA01SHT18](#) [CRS10I30A\(Te85L,QM\)](#) [MBR1240MFST1G](#) [MBRB30H30CT-1G](#) [BAS28E6433HTMA1](#) [BAS 70-02L E6327](#) [HSB123JTR-E](#) [JANTX1N5712-1](#) [VS-STPS40L45CW-N3](#) [DD350N12K](#) [SB007-03C-TB-E](#) [SB10015M-TL-E](#) [SB1003M3-TL-E](#) [SK110-LTP](#)