

### ●Features:

- 2.0A, 650V,  $R_{DS(on)(Typ)} = 4.5\Omega @ V_{GS}=10V$
- Low Gate Charge
- Low  $C_{rSS}$
- 100% Avalanche Tested
- Fast Switching
- Improved dv/dt Capability

### ●Application:

- High Frequency Switching Mode Power Supply
- Active Power Factor Correction

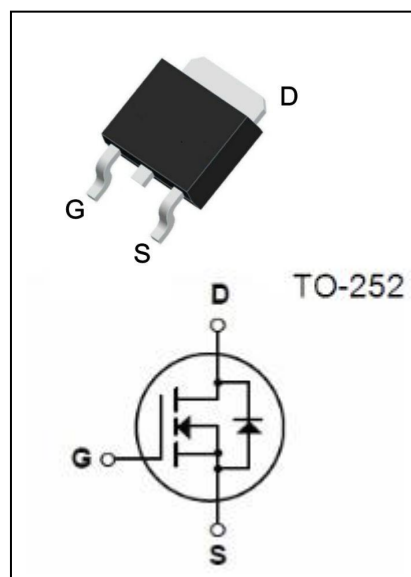

### Absolute Maximum Ratings ( $T_c=25^\circ\text{C}$ unless otherwise noted)

Symbol	Parameter	Value	Unit
$V_{DSS}$	Drain-Source Voltage	650	V
$I_D$	Drain Current - Continuous ( $T_c=25^\circ\text{C}$ ) - Continuous ( $T_c=100^\circ\text{C}$ )	2.0*	A
		1.3*	A
$I_{DM}$	Drain Current - Pulsed (Note1)	8*	A
$V_{GSS}$	Gate-Source Voltage	$\pm 30$	V
$E_{AS}$	Single Pulsed Avalanche Energy (Note2)	120	mJ
$I_{AR}$	Avalanche Current (Note1)	2.0	A
$E_{AR}$	Repetitive Avalanche Energy (Note1)	4.4	mJ
dv/dt	Peak Diode Recovery dv/dt (Note3)	4.5	V/ns
$P_D$	Power Dissipation ( $T_c = 25^\circ\text{C}$ ) - Derate above $25^\circ\text{C}$	44	W
		0.35	W/ $^\circ\text{C}$
$T_j$	Operating Junction Temperature	150	$^\circ\text{C}$
$T_{stg}$	Storage Temperature Range	-55 to +150	$^\circ\text{C}$

\* Drain Current Limited by Maximum Junction Temperature.

### Thermal Characteristics

Symbol	Parameter	Max	Unit
$R_{\theta JC}$	Thermal Resistance, Junction to Case	2.87	$^\circ\text{C} / \text{W}$
$R_{\theta JA}$	Thermal Resistance, Junction to Ambient	110	$^\circ\text{C} / \text{W}$



# SMD2N65

## 650V N-Channel MOSFET

### Electrical Characteristics(Tc=25°C unless otherwise noted)

Symbol	Parameter	Test Conditions	Min	Typ	Max	Unit
<b>Off Characteristics</b>						
BV <sub>DSS</sub>	Drain-source Breakdown Voltage	V <sub>GS</sub> =0V, I <sub>D</sub> =250μA	650	--	--	V
ΔBV <sub>DSS</sub> /ΔT <sub>J</sub>	Breakdown Voltage Temperature Coefficient	I <sub>D</sub> =250μA (Referenced to 25°C)	--	0.65	--	V/°C
I <sub>DSS</sub>	Zero Gate Voltage Drain Current	V <sub>DS</sub> =650V, V <sub>GS</sub> =0V	--	--	1	μA
		V <sub>DS</sub> =520V, Tc=125°C	--	--	10	μA
I <sub>GSSF</sub>	Gate-Body Leakage Current, Forward	V <sub>GS</sub> =+30V, V <sub>DS</sub> =0V	--	--	100	nA
I <sub>GSSR</sub>	Gate-Body Leakage Current, Reverse	V <sub>GS</sub> =-30V, V <sub>DS</sub> =0V	--	--	-100	nA
<b>On Characteristics</b>						
V <sub>GS(th)</sub>	Gate Threshold Voltage	V <sub>DS</sub> = V <sub>GS</sub> , I <sub>D</sub> =250μA	2.0	--	4.0	V
R <sub>DS(on)</sub>	Static Drain-Source On-Resistance	V <sub>GS</sub> =10 V, I <sub>D</sub> =1.0A	--	4.5	5.0	Ω
g <sub>FS</sub>	Forward Transconductance	V <sub>DS</sub> =40 V, I <sub>D</sub> =1.0A (Note4)	--	1.9	--	S
<b>Dynamic Characteristics</b>						
C <sub>iss</sub>	Input Capacitance	V <sub>DS</sub> =25V, V <sub>GS</sub> =0V, f=1.0MHz	--	270	--	pF
C <sub>oss</sub>	Output Capacitance		--	40	--	pF
C <sub>rss</sub>	Reverse Transfer Capacitance		--	5	--	pF
<b>Switching Characteristics</b>						
t <sub>d(on)</sub>	Turn-On Delay Time	V <sub>DD</sub> = 325 V, I <sub>D</sub> = 2.0 A, R <sub>G</sub> = 25 Ω (Note4,5)	--	7	--	ns
t <sub>r</sub>	Turn-On Rise Time		--	23	--	ns
t <sub>d(off)</sub>	Turn-Off Delay Time		--	2	--	ns
t <sub>f</sub>	Turn-Off Fall Time		--	24	--	ns
Q <sub>g</sub>	Total Gate Charge	V <sub>DS</sub> = 520 V, I <sub>D</sub> =2.0 A, V <sub>GS</sub> = 10 V (Note4,5)	--	9	--	nC
Q <sub>gs</sub>	Gate-Source Charge		--	1.6	--	nC
Q <sub>gd</sub>	Gate-Drain Charge		--	4.3	--	nC
<b>Drain-Source Diode Characteristics and Maximum Ratings</b>						
I <sub>S</sub>	Maximum Continuous Drain-Source Diode Forward Current		--	--	2.0	A
I <sub>SM</sub>	Maximum Pulsed Drain-Source Diode Forward Current		--	--	8	A
V <sub>SD</sub>	Drain-Source Diode Forward Voltage	V <sub>GS</sub> =0V, I <sub>S</sub> =2.0A	--	--	1.4	V
t <sub>rr</sub>	Reverse Recovery Time	V <sub>GS</sub> =0V, I <sub>S</sub> =2.0A, d I <sub>F</sub> /dt=100A/μs (Note4)	--	230	--	ns
Q <sub>rr</sub>	Reverse Recovery Charge		--	1.0	--	μC

#### Notes:

- 1、Repetitive Rating:Pulse Width Limited by Maximum Junction Temperature.
- 2、L = 56.0mH, I<sub>AS</sub> =2.0A, V<sub>DD</sub> = 50V, R<sub>G</sub> = 25 Ω, Starting T<sub>J</sub> = 25°C.
- 3、I<sub>SD</sub>≤2.0A, di/dt≤200A/μs, V<sub>DD</sub>≤BV<sub>DSS</sub>, Starting T<sub>J</sub> = 25°C.
- 4、Pulse Test : Pulse Width ≤300 μ s, Duty Cycle≤2%.
- 5、Essentially Independent of Operating Temperature.

### On-Regin Characteristics

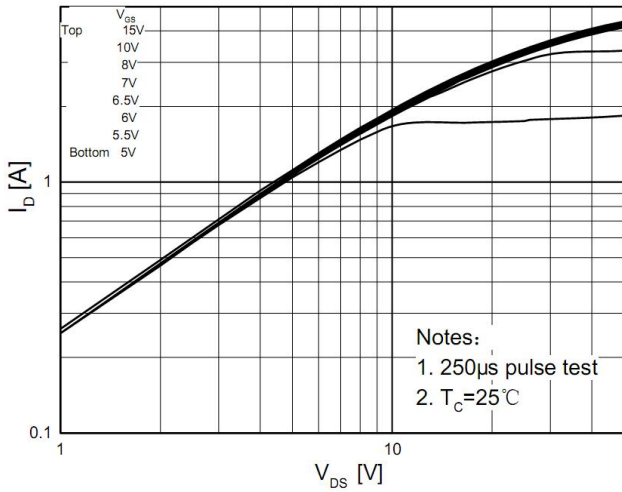

### Transfer Characteristics

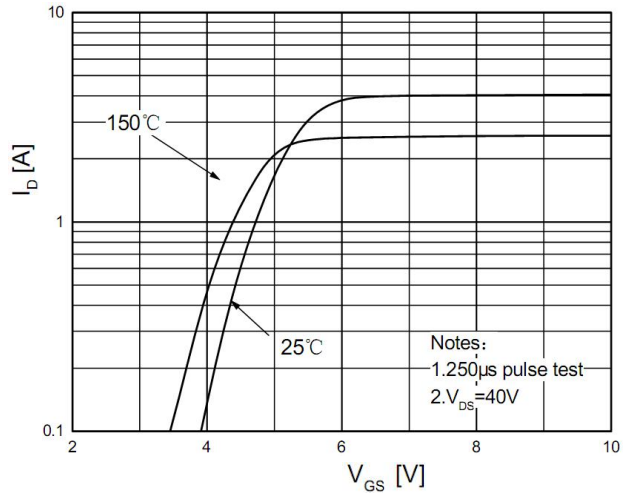

### On-Resistance Variation vs. Drain Current and Gate Voltage

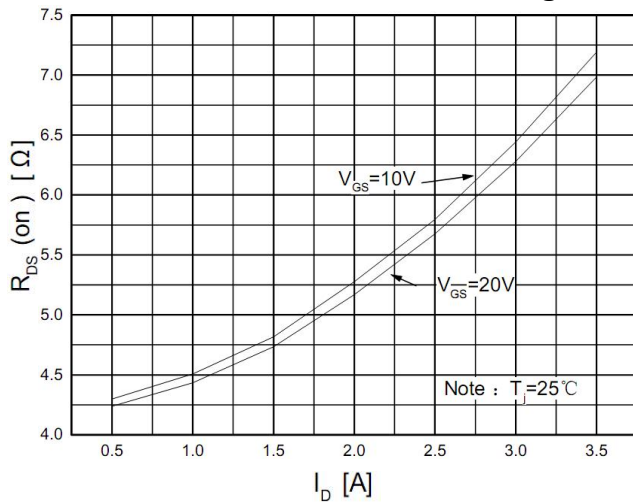

### Body Diode Forward Voltage Variation vs. Source Current and Temperature

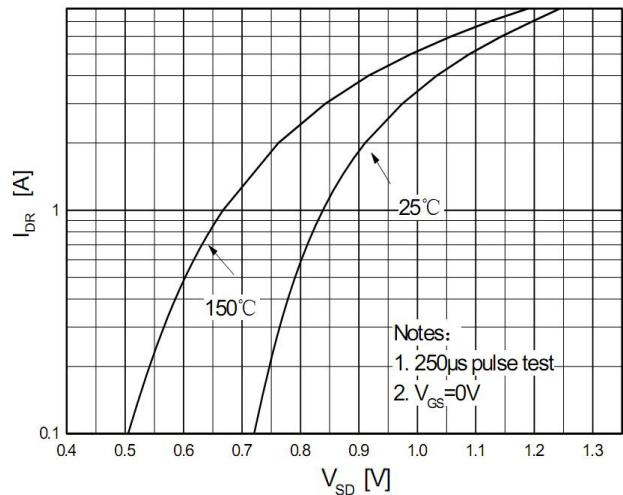

### Capacitance Characteristics

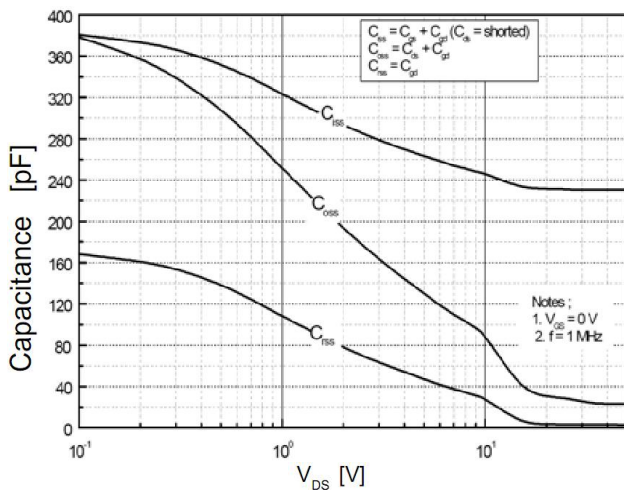

### Gate Charge Characteristics

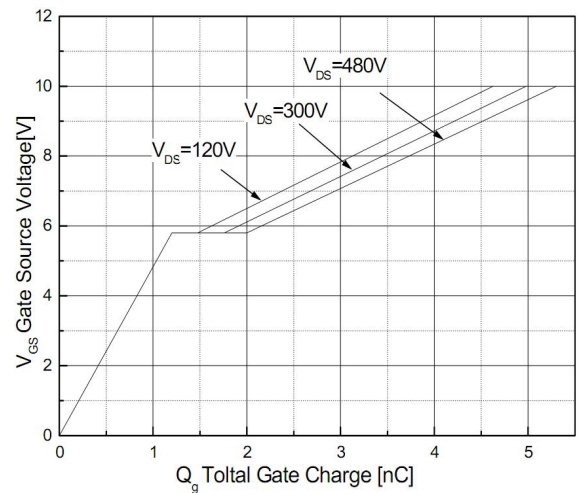

### Breakdown Voltage Variation vs. Temperature

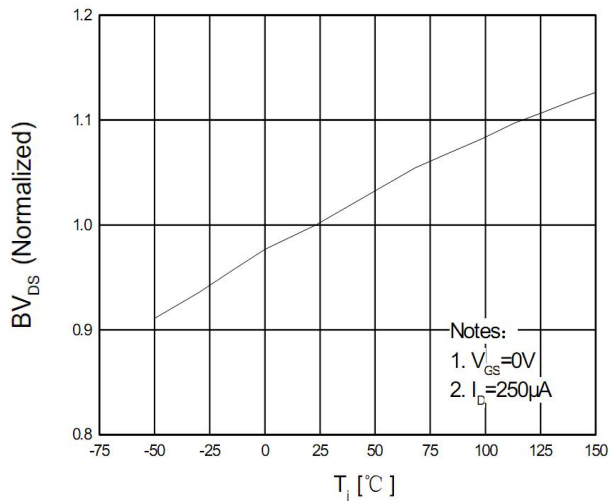

### On-Resistance Variation vs. Temperature

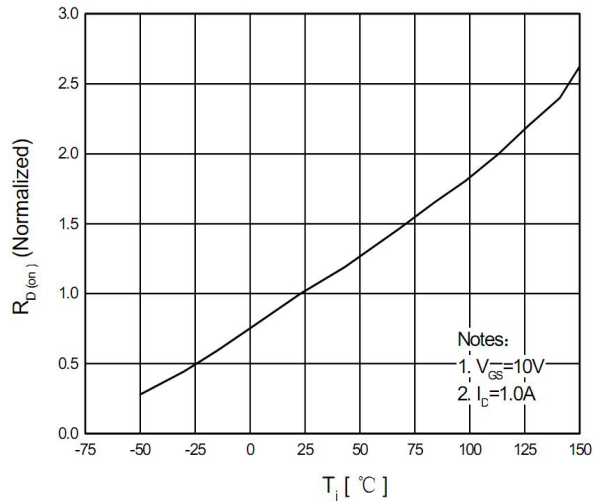

### Maximum Safe Operating Area

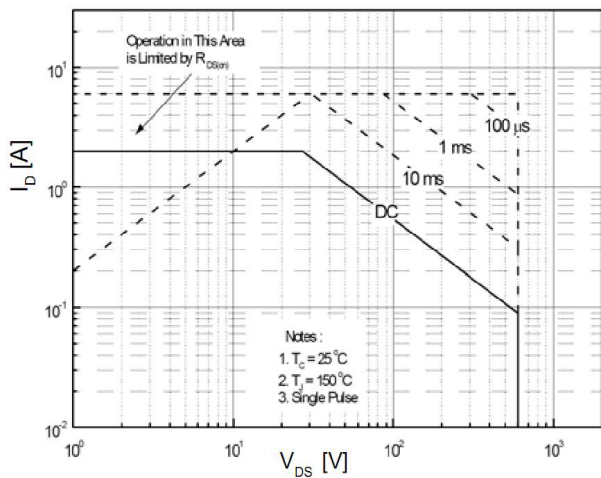

### Maximum Drain Current Vs. Case Temperature

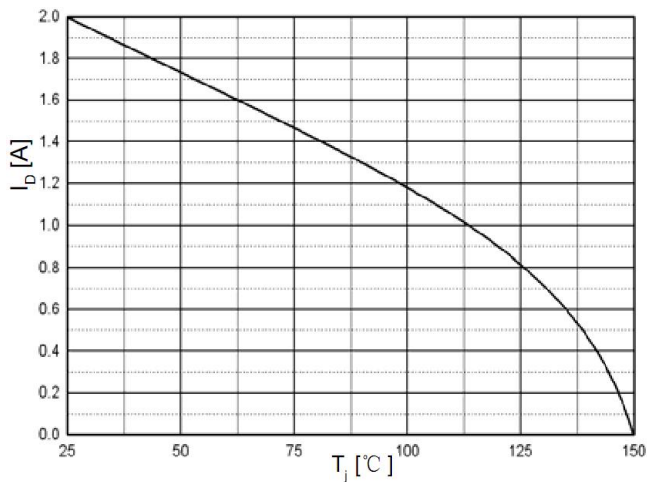

**TO-252 Package Dimensions**

UNIT: mm

SYMBOL	min	nom	max	SYMBOL	min	nom	max
A	6.40		6.60	D	2.90		3.10
A1	5.20		5.40	D1	0.45		0.55
A2	4.40		4.60	D2	0.45		0.55
A3	4.40		4.60	e		2.30	
A4	0		0.15	E	2.20		2.40
A5	4.65		4.95	F	0.45		0.55
B	5.90		6.20	G		1.70	
B1	1.57		1.77	L	1.40		1.60
C	0.90		0.96	$\theta$ (度)	0		10.00

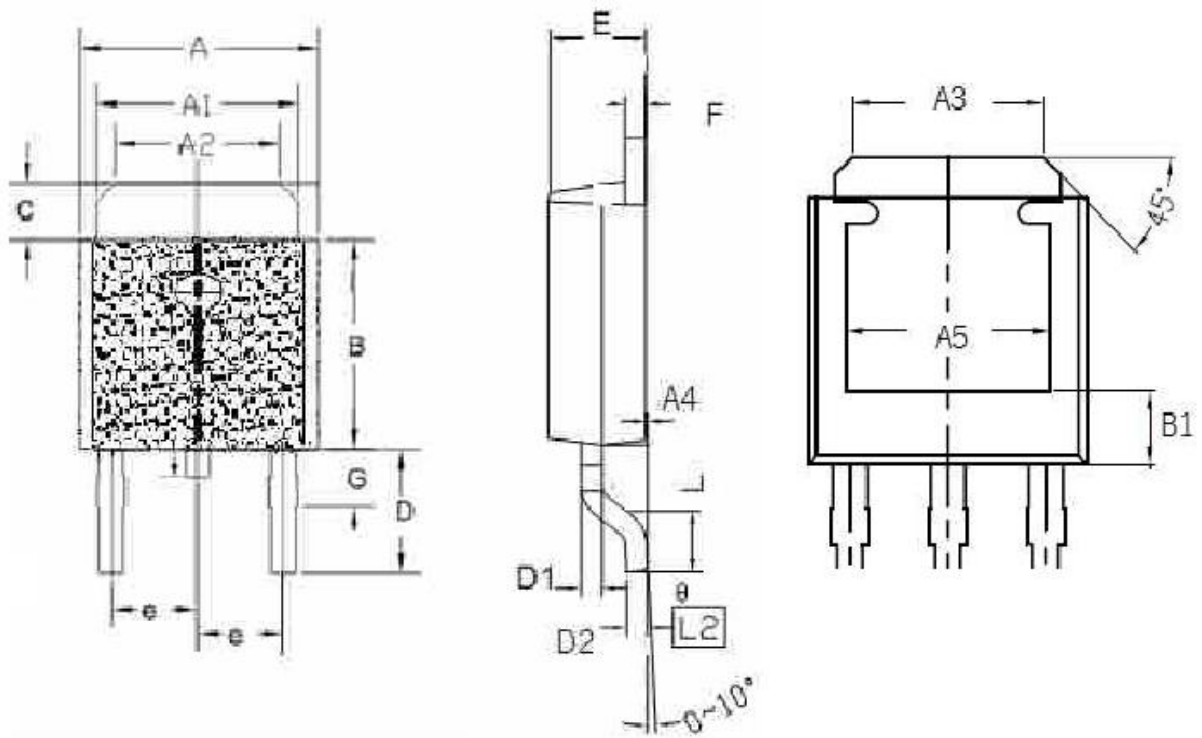

## X-ON Electronics

Largest Supplier of Electrical and Electronic Components

*Click to view similar products for [MOSFET](#) category:*

*Click to view products by [HUAKE](#) manufacturer:*

Other Similar products are found below :

[614233C](#) [648584F](#) [MCH3443-TL-E](#) [MCH6422-TL-E](#) [FDPF9N50NZ](#) [FW216A-TL-2W](#) [FW231A-TL-E](#) [APT5010JVR](#) [NTNS3A92PZT5G](#)  
[IRF100S201](#) [JANTX2N5237](#) [2SK2464-TL-E](#) [2SK3818-DL-E](#) [FCA20N60\\_F109](#) [FDZ595PZ](#) [STD6600NT4G](#) [FSS804-TL-E](#) [2SJ277-DL-E](#)  
[2SK1691-DL-E](#) [2SK2545\(Q,T\)](#) [D2294UK](#) [405094E](#) [423220D](#) [MCH6646-TL-E](#) [TPCC8103,L1Q\(CM](#) [367-8430-0972-503](#) [VN1206L](#)  
[424134F](#) [026935X](#) [051075F](#) [SBVS138LT1G](#) [614234A](#) [715780A](#) [NTNS3166NZT5G](#) [751625C](#) [873612G](#) [IRF7380TRHR](#)  
[IPS70R2K0CEAKMA1](#) [RJK60S3DPP-E0#T2](#) [RJK60S5DPK-M0#T0](#) [APT5010JVFR](#) [APT12031JFLL](#) [APT12040JVR](#) [DMN3404LQ-7](#)  
[NTE6400](#) [JANTX2N6796U](#) [JANTX2N6784U](#) [JANTXV2N5416U4](#) [SQM110N05-06L-GE3](#) [SIHF35N60E-GE3](#)