



产品规格书

PRODUCT SPECIFICATION

客户名称 CUSTOMER: _____

产品型号 MODEL: HMB1275-24B

客户型号 USER'S MODEL: _____

日期 DATE: 2019-12-12

江苏华能电子有限公司			客户回签		
HUAWHA			CUSTOMER		
SERVE RATITY			CUSTOMER RATIGY		
拟制	审核	批准	检验	审核	批准
REPORT	CHECKED	APPROVED	TEST	CHECKED	APPROVED
王文娟	工稿用章	张长华			

江苏华能电子有限公司

JIANGSU HUAWHA ELECTRONICS CO.,LTD

地址：江苏省泰州市兴化市陈堡镇工业园区

ADD:Chenbao Industrial Park, Chenbao Town, Xinghua,Taizhou City, Jiangsu China.

电话 [TEL:0523-83710666](tel:0523-83710666)

传真 [FAX:0523-83724866](tel:0523-83724866)

网址: www.huawha.com

邮箱: hndz_wwj@huawha.com

1.基本规格/General specification

项目/Item		规格/Spec	条件/Condition
1	额定电压 Rated voltage	24VDC	
2	工作电压 Operation voltage	18~28VDC	
3	声压 Sound Pressure Level=SPL	Min 85dB	测试环境：标准状态，标准驱动电路， 额定电压 测试距离：0.1m Standard State,Standard Drive Circuit. Rated voltage,Distance at 0.1m
4	电流 current	Max25mA	
5	振荡频率 Oscillation frequency	2400±300Hz	
6	工作温度范围 Operating Temperature	-20~+70℃	
7	保存温度范围 Storage temperature	-40~+85℃	
8	外部尺寸 Externals size (mm)	φ 12*H7.5	参阅附图 Refer to the attached drawing
9	重量 Mass	1.8g	
10	材质 Housing Material	PBT	

2.电气和声学测试条件/Electrical And Acoustical Measuring Condition

驱动电路/Recommended Driving Circuit

设置 Recommended Setting

Resonant frequency, 1/2 duty cycle. Square wave.
Signal amplitude should be large enough to saturate the transistor.

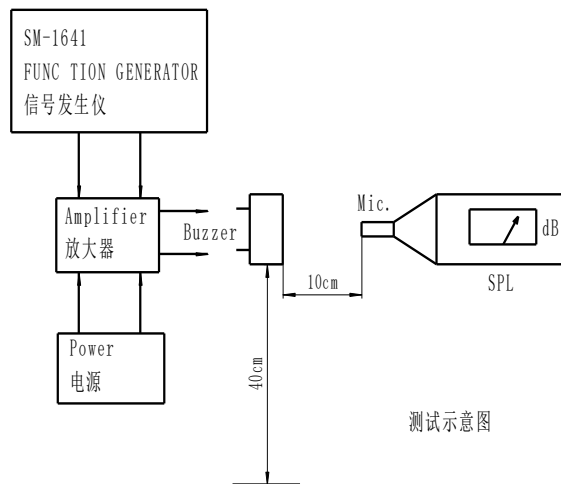
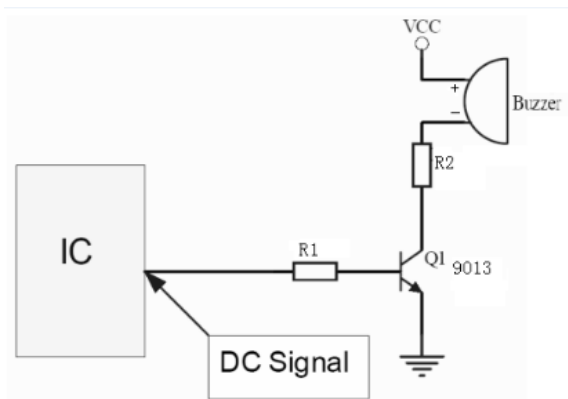

3.可靠性测试/Reliability Test

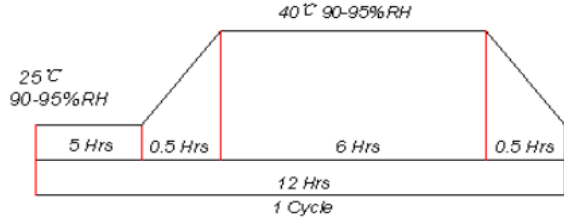
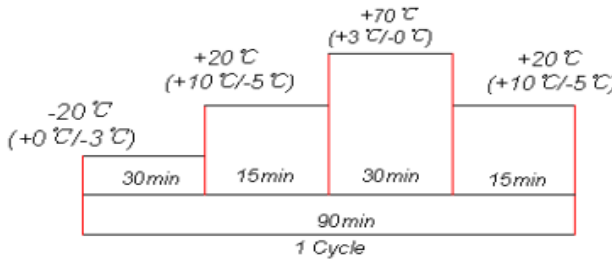
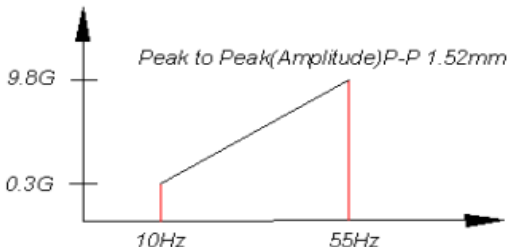
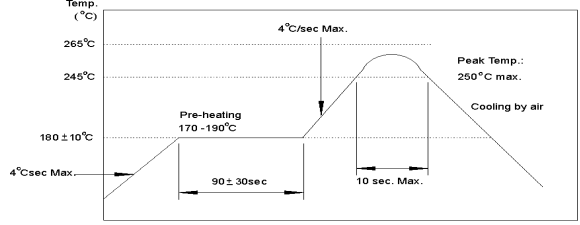
	项目 ITEM	测试方法 TEST
1	高温试验 High Temperature Test	在+80℃±2℃储存温度下存放 96 小时，恢复 2 小时后测试 After being placed in a chamber with +80±2℃ for 96 hours and then being placed in normal condition for 2 hours
2	低温试验 Low Temperature Test	在-20℃±2℃储存温度下存放 96 小时，恢复 2 小时后测试 After being placed in a chamber with -20±2℃ for 96 hours and then being placed in normal condition for 2 hours
3	恒定湿热试验 Humidity Test	 <p>The diagram shows a humidity test cycle. It starts with a 5-hour dwell at 25°C and 90-95% RH. This is followed by a 0.5-hour ramp up to 40°C and 90-95% RH. The test then holds at 40°C and 90-95% RH for 6 hours. Finally, there is a 0.5-hour ramp down. The total cycle duration is 12 hours.</p>
4	温度变化试验 Temperature Cycle Test	 <p>The diagram shows a temperature cycle test. It starts with a 30-minute dwell at -20°C (+0°C/-3°C). This is followed by a 15-minute ramp up to +20°C (+10°C/-5°C). The test then holds at +20°C for 30 minutes. This is followed by a 15-minute ramp up to +70°C (+3°C/-0°C). The test then holds at +70°C for 30 minutes. Finally, there is a 15-minute ramp down to +20°C (+10°C/-5°C). The total cycle duration is 90 minutes.</p>
5	振动试验 Vibration Test	 <p>The diagram shows a vibration test profile. The amplitude starts at 0.3G at 10Hz and increases linearly to 9.8G at 55Hz. The peak-to-peak amplitude is 1.52mm.</p>
6	跌落试验 Drop Test	70cm 高自由掉落到 40mm 的木板上，每个方向三次 Drop on a hard wood board of 40mm thick, any directions, three times, at the height of 70cm
7	插针的抗拉强度试验 Terminal Strength Pulling Test	插针承受 1.0kg 拉力，负荷时间 5s The force 5 seconds of 1.0kg is applied to each terminal.
8	可焊性试验 Solder ability Test	焊锡温度 255±5℃，浸润时间为 3±0.5s，试验后目测产品情况 Lead terminals are immersed in rosin for 5 seconds and then immersed in solder bath of 255±5℃ for 3±0.5 seconds.
9	回流焊测试 Soldering Test	 <p>The diagram shows a soldering test temperature profile. It starts with a 4°C/sec Max. ramp up to 180±10°C. This is followed by a pre-heating dwell at 170-190°C for 90±30sec. The test then ramps up at 4°C/sec Max. to a peak temperature of 250°C max. The dwell at peak temperature is 10 sec. Max. Finally, the test cools by air.</p>

--	--	--

4.尺寸图 Dimension

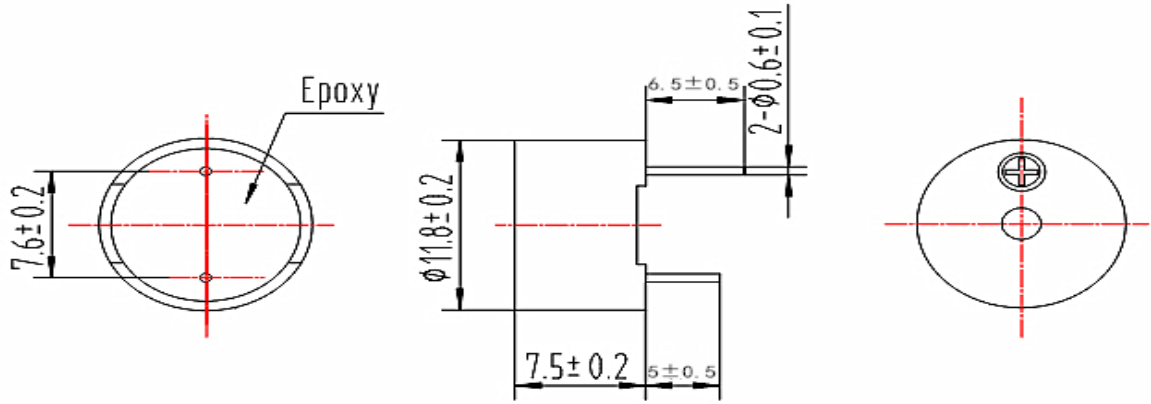

*Unit: mm; Tolerance: ± 0.3 mm Except Specified

*Housing Material: Black PBT

5.频率响应/Frequency Response

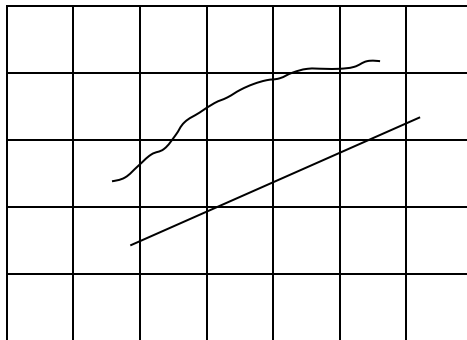

90DB

25MA

85DB

16 24 32 VDC

16Vo-p 50% duty Square wave,10cm

5.包装 picking



QTY:100PCS



QTY:1000PCS



QTY:5000PCS

SIZE:50*42*27cm

X-ON Electronics

Largest Supplier of Electrical and Electronic Components

Click to view similar products for [Piezo Buzzers & Audio Indicators](#) category:

Click to view products by [Huaneng](#) manufacturer:

Other Similar products are found below :

[6-4](#) [68S1240-PA](#) [ESZ-26B](#) [FDG06PSLLF](#) [F/DGX12P WITH LABEL LF](#) [F/EM12PLF](#) [PF-35N29WQ](#) [PFD-21A29W](#) [PFD-27A35PQ](#) [PL-21N30WQ](#) [PL-27A35PSQ](#) [PLD-21N30W](#) [PLD-21N30WQ](#) [PS-531Q](#) [PT-3534FP](#) [B822B](#) [B/CP28/100DB/BLACK LF](#) [S6109](#) [SC110E](#) [SC2036ACP](#) [SC616N-2](#) [SC628FW](#) [SC628MPG](#) [SC648D](#) [SCS045MD9DT3S](#) [ESZ-25B-5-250B](#) [ESZ-25S](#) [F/BC 35-DR LF](#) [FCM12PLF](#) [SSX-52SA](#) [F/EB20P-DR LF](#) [AI-4228-TF-LW305-R](#) [FSMD8585JSLF](#) [F/SU 21-02 LF](#) [F/TCW 05 WITH LABEL LF](#) [PFD-27N36W](#) [PKM35-4A0](#) [PL-35N29WQ](#) [PLD-27A35PQ](#) [PS-552Q](#) [CM-5](#) [REF-202](#) [B/SE 128 RED LF](#) [KBS-20DA-7AS](#) [KBS-27DA-5C-105](#) [LSC628ANR](#) [03-810.001](#) [RTO-1R07-001](#) [PL-21N31PQ](#) [F-B-P1405ISB LF](#)