

Dual N-Ch 30V Fast Switching MOSFETs
Description

The HSBA3202 is the high cell density trenched N-ch MOSFETs, which provide excellent R_{DS(ON)} and gate charge for most of the synchronous buck converter applications. The HSBA3202 meet the RoHS and Green Product requirement, 100% EAS guaranteed with full function reliability approved.

- Super Low Gate Charge
- 100% EAS Guaranteed
- Green Device Available
- Excellent CdV/dt effect decline
- Advanced high cell density Trench technology

Product Summary

| | | |
|-------------------------|----|----|
| V _{DS} | 30 | V |
| R _{DS(ON),TYP} | 15 | mΩ |
| I _D | 35 | A |

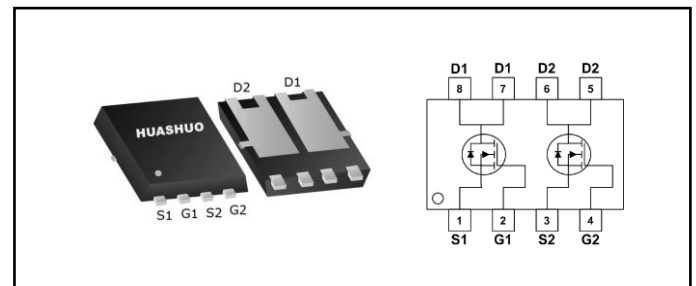
PRPAK5*6 Pin Configuration

Absolute Maximum Ratings

| Symbol | Parameter | Rating | Units |
|---------------------------------------|--|------------|-------|
| V _{DS} | Drain-Source Voltage | 30 | V |
| V _{GS} | Gate-Source Voltage | ±20 | V |
| I _D @T _C =25°C | Continuous Drain Current, V _{GS} @ 10V ¹ | 35 | A |
| I _D @T _C =100°C | Continuous Drain Current, V _{GS} @ 10V ¹ | 22 | A |
| I _{DM} | Pulsed Drain Current ² | 70 | A |
| EAS | Single Pulse Avalanche Energy ³ | 22.1 | mJ |
| I _{AS} | Avalanche Current | 20 | A |
| P _D @T _C =25°C | Total Power Dissipation ⁴ | 42 | W |
| T _{STG} | Storage Temperature Range | -55 to 150 | °C |
| T _J | Operating Junction Temperature Range | -55 to 150 | °C |

Thermal Data

| Symbol | Parameter | Typ. | Max. | Unit |
|------------------|--|------|------|------|
| R _{θJA} | Thermal Resistance Junction-ambient ¹ | --- | 62 | °C/W |
| R _{θJC} | Thermal Resistance Junction-Case ¹ | --- | 3 | °C/W |

Electrical Characteristics ($T_J=25\text{ }^\circ\text{C}$, unless otherwise noted)

| Symbol | Parameter | Conditions | Min. | Typ. | Max. | Unit |
|------------------------------|--|--|------|-------|-----------|---------------------|
| BV_{DSS} | Drain-Source Breakdown Voltage | $V_{GS}=0V, I_D=250\mu A$ | 30 | --- | --- | V |
| $\Delta BV_{DSS}/\Delta T_J$ | BVDSS Temperature Coefficient | Reference to 25°C , $I_D=1\text{mA}$ | --- | 0.034 | --- | $V/^\circ\text{C}$ |
| $R_{DS(ON)}$ | Static Drain-Source On-Resistance ² | $V_{GS}=10V, I_D=10A$ | --- | 15 | 18 | $m\Omega$ |
| | | $V_{GS}=4.5V, I_D=10A$ | --- | 21 | 30 | |
| $V_{GS(th)}$ | Gate Threshold Voltage | $V_{GS}=V_{DS}, I_D=250\mu A$ | 1.2 | 1.7 | 2.3 | V |
| $\Delta V_{GS(th)}$ | $V_{GS(th)}$ Temperature Coefficient | | --- | -5.8 | --- | $mV/^\circ\text{C}$ |
| I_{DSS} | Drain-Source Leakage Current | $V_{DS}=30V, V_{GS}=0V, T_J=25^\circ\text{C}$ | --- | --- | 1 | μA |
| | | $V_{DS}=30V, V_{GS}=0V, T_J=55^\circ\text{C}$ | --- | --- | 5 | |
| I_{GSS} | Gate-Source Leakage Current | $V_{GS}=\pm 20V, V_{DS}=0V$ | --- | --- | ± 100 | nA |
| g_{fs} | Forward Transconductance | $V_{DS}=5V, I_D=10A$ | --- | 12 | --- | S |
| R_g | Gate Resistance | $V_{DS}=0V, V_{GS}=0V, f=1\text{MHz}$ | --- | 2.5 | --- | Ω |
| Q_g | Total Gate Charge (4.5V) | $V_{DS}=15V, V_{GS}=4.5V, I_D=7A$ | --- | 4.6 | --- | nC |
| Q_{gs} | Gate-Source Charge | | --- | 1.85 | --- | |
| Q_{gd} | Gate-Drain Charge | | --- | 1.6 | --- | |
| $T_{d(on)}$ | Turn-On Delay Time | $V_{DD}=15V, V_{GS}=10V, R_G=3.3\Omega, I_D=7A$ | --- | 7 | --- | ns |
| T_r | Rise Time | | --- | 13 | --- | |
| $T_{d(off)}$ | Turn-Off Delay Time | | --- | 19 | --- | |
| T_f | Fall Time | | --- | 3.4 | --- | |
| C_{iss} | Input Capacitance | $V_{DS}=15V, V_{GS}=0V, f=1\text{MHz}$ | --- | 491 | --- | pF |
| C_{oss} | Output Capacitance | | --- | 80 | --- | |
| C_{rss} | Reverse Transfer Capacitance | | --- | 57 | --- | |

Diode Characteristics

| Symbol | Parameter | Conditions | Min. | Typ. | Max. | Unit |
|----------|--|---|------|------|------|------|
| I_S | Continuous Source Current ^{1,5} | $V_G=V_D=0V$, Force Current | --- | --- | 10 | A |
| V_{SD} | Diode Forward Voltage ² | $V_{GS}=0V, I_S=1A, T_J=25^\circ\text{C}$ | --- | --- | 1 | V |

Note :

- 1.The data tested by surface mounted on a 1 inch² FR-4 board with 2OZ copper.
- 2.The data tested by pulsed , pulse width $\leq 300\mu s$, duty cycle $\leq 2\%$
- 3.The EAS data shows Max. rating . The test condition is $V_{DD}=25V, V_{GS}=10V, L=0.1\text{mH}, I_{AS}=20A$
- 4.The power dissipation is limited by 150°C junction temperature
- 5.The data is theoretically the same as I_D and I_{DM} , in real applications , should be limited by total power dissipation.



Typical Characteristics

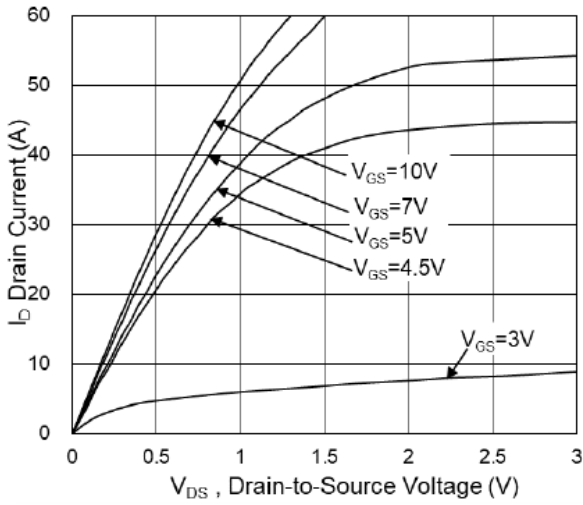

Fig.1 Typical Output Characteristics

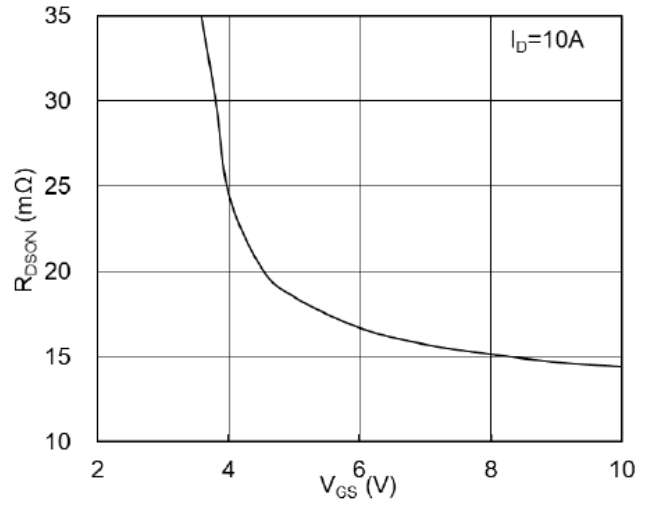

Fig.2 On-Resistance vs. G-S Voltage

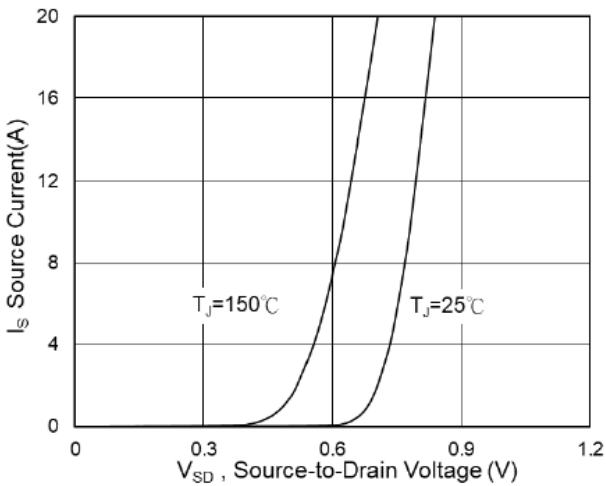

Fig.3 Forward Characteristics Of Reverse

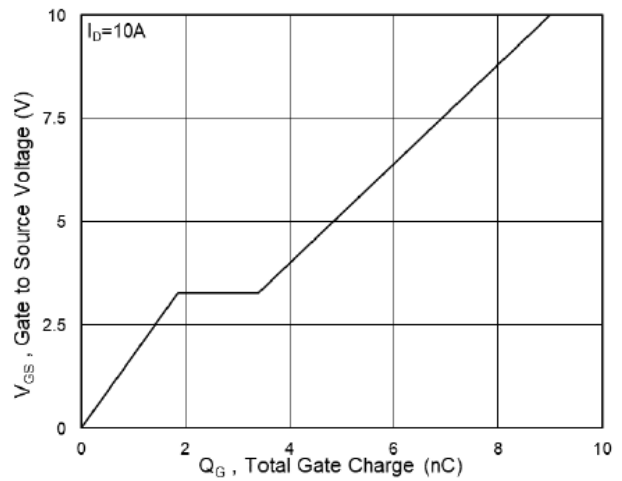

Fig.4 Gate-Charge Characteristics

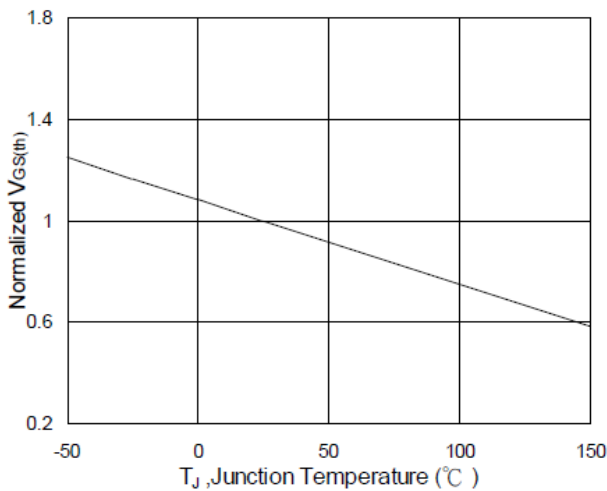

Fig.5 Normalized $V_{GS(th)}$ vs. T_J

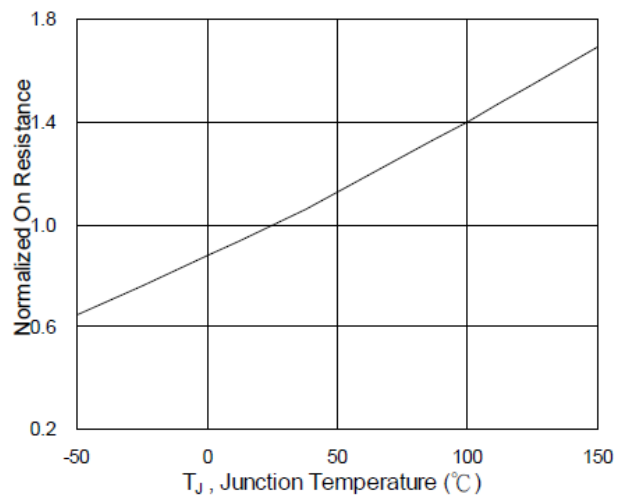

Fig.6 Normalized $R_{DS(on)}$ vs. T_J



Dual N-Ch 30V Fast Switching MOSFETs

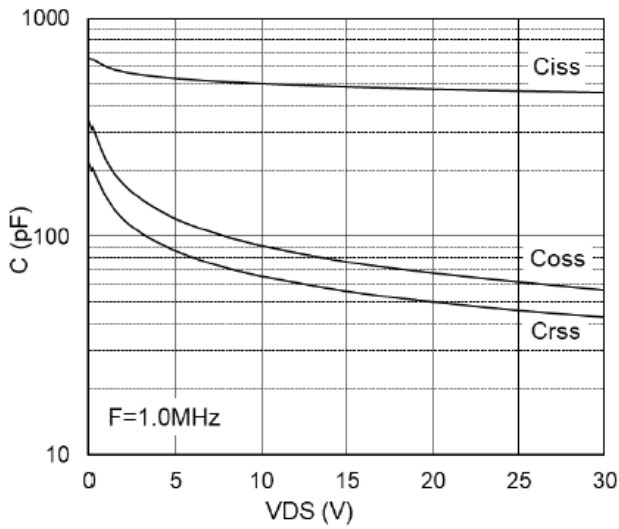

Fig.7 Capacitance

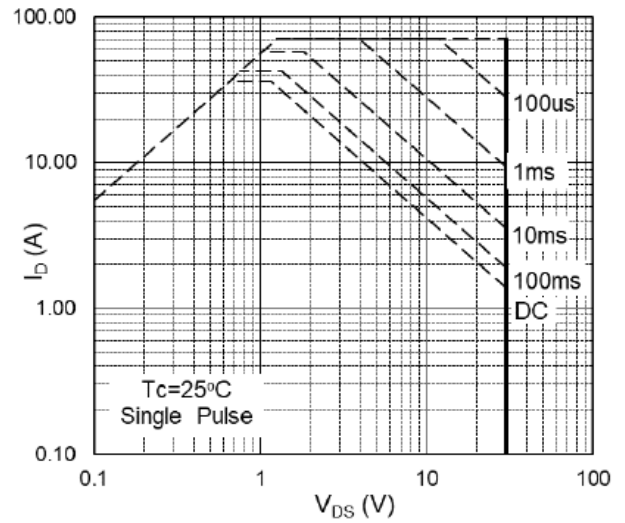

Fig.8 Safe Operating Area

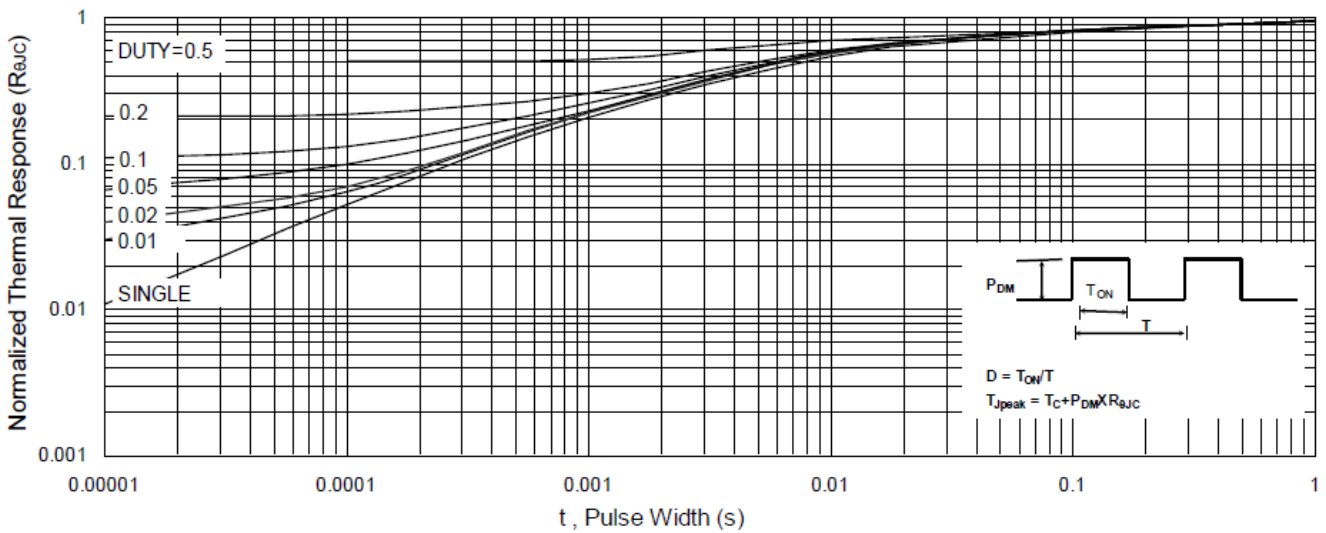

Fig.9 Normalized Maximum Transient Thermal Impedance

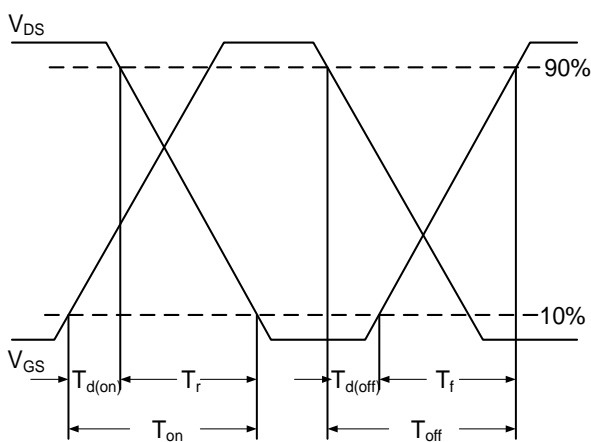

Fig.10 Switching Time Waveform

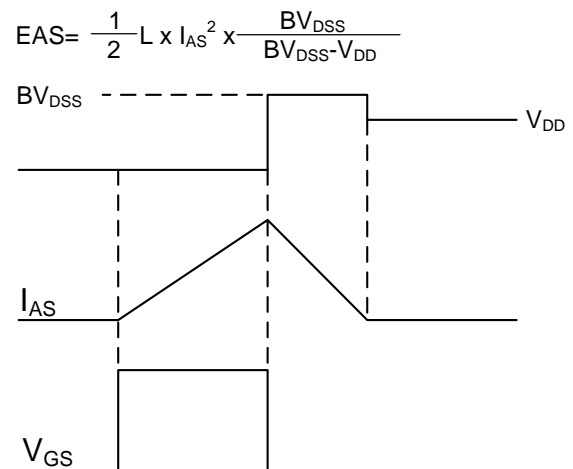

Fig.11 Unclamped Inductive Switching

X-ON Electronics

Largest Supplier of Electrical and Electronic Components

Click to view similar products for [MOSFET](#) category:

Click to view products by [HUASHUO](#) manufacturer:

Other Similar products are found below :

[IRFD120](#) [JANTX2N5237](#) [2SK2267\(Q\)](#) [BUK455-60A/B](#) [TK100A10N1,S4X\(S](#) [MIC4420CM-TR](#) [VN1206L](#) [NDP4060](#) [SI4482DY](#)
[IRS2092STRPBF-EL](#) [IPS70R2K0CEAKMA1](#) [TK31J60W5,S1VQ\(O](#) [TK31J60W,S1VQ\(O](#) [TK16J60W,S1VQ\(O](#) [2SK2614\(TE16L1,Q\)](#)
[DMN1017UCP3-7](#) [EFC2J004NUZTDG](#) [P85W28HP2F-7071](#) [DMN1053UCP4-7](#) [NTE2384](#) [DMC2700UDMQ-7](#) [DMN2080UCB4-7](#)
[DMN61D9UWQ-13](#) [US6M2GTR](#) [DMN31D5UDJ-7](#) [DMP22D4UFO-7B](#) [IPS60R3K4CEAKMA1](#) [DMN1006UCA6-7](#) [DMN16M9UCA6-7](#)
[STF5N65M6](#) [IRF40H233XTMA1](#) [STU5N65M6](#) [DMN6022SSD-13](#) [DMN13M9UCA6-7](#) [DMTH10H4M6SPS-13](#) [IPS60R360PFD7SAKMA1](#)
[DMN2990UFB-7B](#) [SSM3K35CT,L3F](#) [IPLK60R1K0PFD7ATMA1](#) [2N7002W-G](#) [MCAC30N06Y-TP](#) [IPWS65R035CFD7AXKSA1](#)
[MCQ7328-TP](#) [SSM3J143TU,LXHF](#) [DMN12M3UCA6-7](#) [PJMF280N65E1_T0_00201](#) [PJMF380N65E1_T0_00201](#)
[PJMF280N60E1_T0_00201](#) [PJMF600N65E1_T0_00201](#) [PJMF900N65E1_T0_00201](#)