

Description

The HSBB3052 is the high cell density trench N-ch MOSFETs, which provide excellent RDS(on) and gate charge for most of the synchronous buck converter applications.

The HSBB3052 meet the RoHS and Green Product requirement, 100% EAS guaranteed with full function reliability approved.

- 100% EAS Guaranteed
- Green Device Available
- Super Low Gate Charge
- Excellent CdV/dt effect decline
- Advanced high cell density Trench technology

Product Summary

V_{DS}	30	V
$R_{DS(ON),typ}$	5	m Ω
I_D	30	A

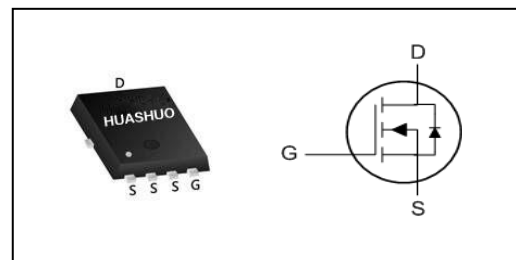
PRPAK3X3 Pin Configuration

Absolute Maximum Ratings

Symbol	Parameter	Rating	Units
V_{DS}	Drain-Source Voltage	30	V
V_{GS}	Gate-Source Voltage	± 20	V
$I_D @ T_C=25^\circ C$	Continuous Drain Current, $V_{GS} @ 10V^1$	30	A
$I_D @ T_C=100^\circ C$	Continuous Drain Current, $V_{GS} @ 10V^1$	24	A
$I_D @ T_A=25^\circ C$	Continuous Drain Current, $V_{GS} @ 10V^1$	20	A
$I_D @ T_A=70^\circ C$	Continuous Drain Current, $V_{GS} @ 10V^1$	15	A
I_{DM}	Pulsed Drain Current ²	100	A
EAS	Single Pulse Avalanche Energy ³	28.8	mJ
I_{AS}	Avalanche Current	24	A
$P_D @ T_C=25^\circ C$	Total Power Dissipation ⁴	24	W
T_{STG}	Storage Temperature Range	-55 to 150	$^\circ C$
T_J	Operating Junction Temperature Range	-55 to 150	$^\circ C$

Thermal Data

Symbol	Parameter	Typ.	Max.	Unit
$R_{\theta JA}$	Thermal Resistance Junction-Ambient ¹	---	60	$^\circ C/W$
$R_{\theta JC}$	Thermal Resistance Junction-Case ¹	---	5.2	$^\circ C/W$

Electrical Characteristics ($T_J=25\text{ }^\circ\text{C}$, unless otherwise noted)

Symbol	Parameter	Conditions	Min.	Typ.	Max.	Unit
BV_{DSS}	Drain-Source Breakdown Voltage	$V_{GS}=0V, I_D=250\mu A$	30	---	---	V
$R_{DS(ON)}$	Static Drain-Source On-Resistance ²	$V_{GS}=10V, I_D=20A$	---	5	6.3	m Ω
		$V_{GS}=4.5V, I_D=15A$	---	6.9	9	
$V_{GS(th)}$	Gate Threshold Voltage	$V_{GS}=V_{DS}, I_D=250\mu A$	1.2	---	2.5	V
I_{DSS}	Drain-Source Leakage Current	$V_{DS}=24V, V_{GS}=0V, T_J=25^\circ\text{C}$	---	---	1	μA
		$V_{DS}=24V, V_{GS}=0V, T_J=55^\circ\text{C}$	---	---	5	
I_{GSS}	Gate-Source Leakage Current	$V_{GS}=\pm 20V, V_{DS}=0V$	---	---	± 100	nA
g_{fs}	Forward Transconductance	$V_{DS}=5V, I_D=30A$	---	43	---	S
R_g	Gate Resistance	$V_{DS}=0V, V_{GS}=0V, f=1\text{MHz}$	---	1.7	---	Ω
Q_g	Total Gate Charge (4.5V)	$V_{DS}=15V, V_{GS}=4.5V, I_D=15A$	---	8	---	nC
Q_{gs}	Gate-Source Charge		---	2.4	---	
Q_{gd}	Gate-Drain Charge		---	3.2	---	
$T_{d(on)}$	Turn-On Delay Time	$V_{DD}=15V, V_{GS}=10V, R_G=3.3\Omega, I_D=15A$	---	7.1	---	ns
T_r	Rise Time		---	40	---	
$T_{d(off)}$	Turn-Off Delay Time		---	15	---	
T_f	Fall Time		---	6	---	
C_{iss}	Input Capacitance	$V_{DS}=15V, V_{GS}=0V, f=1\text{MHz}$	---	814	---	pF
C_{oss}	Output Capacitance		---	498	---	
C_{rss}	Reverse Transfer Capacitance		---	41	---	

Diode Characteristics

Symbol	Parameter	Conditions	Min.	Typ.	Max.	Unit
I_S	Continuous Source Current ^{1,6}	$V_G=V_D=0V, \text{Force Current}$	---	---	24	A
V_{SD}	Diode Forward Voltage ²	$V_{GS}=0V, I_S=1A, T_J=25^\circ\text{C}$	---	---	1	V
t_{rr}	Reverse Recovery Time	$I_F=15A, di/dt=100A/\mu s,$	---	34	---	nS
Q_{rr}	Reverse Recovery Charge	$T_J=25^\circ\text{C}$	---	15	---	nC

Note :

- 1.The data tested by surface mounted on a 1 inch² FR-4 board with 2OZ copper.
- 2.The data tested by pulsed , pulse width $\leq 300\mu s$, duty cycle $\leq 2\%$
- 3.The EAS data shows Max. rating . The test condition is $V_{DD}=25V, V_{GS}=10V, L=0.1mH, I_{AS}=24A$
- 4.The power dissipation is limited by 150 $^\circ\text{C}$ junction temperature
- 5.The data is theoretically the same as I_D and I_{DM} , in real applications , should be limited by total power dissipation.

Typical Characteristics

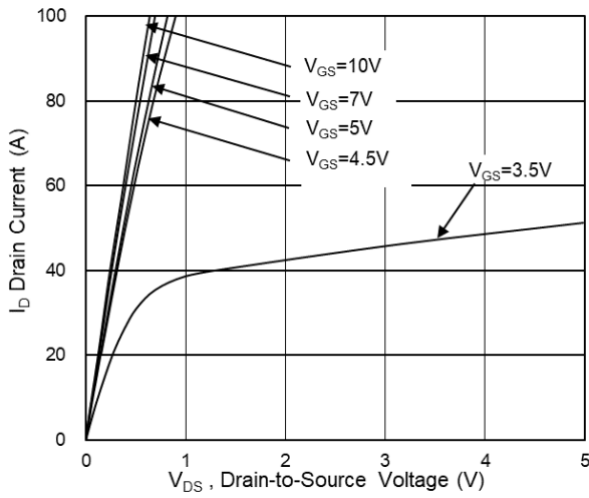

Fig.1 Typical Output Characteristics

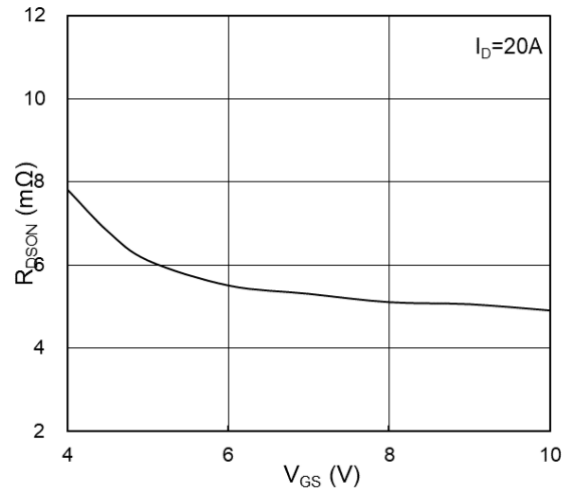

Fig.2 On-Resistance vs G-S Voltage

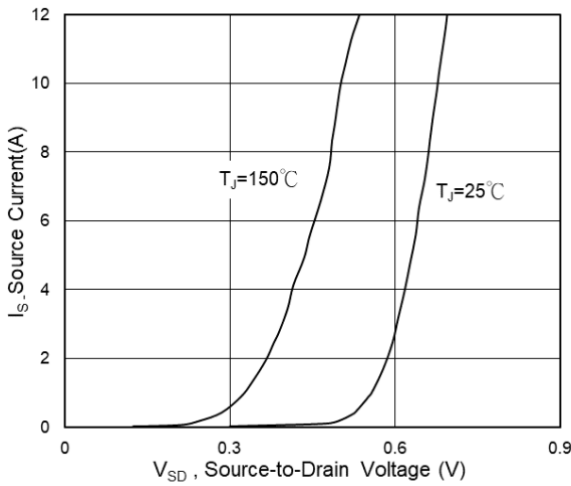

Fig.3 Source Drain Forward Characteristics

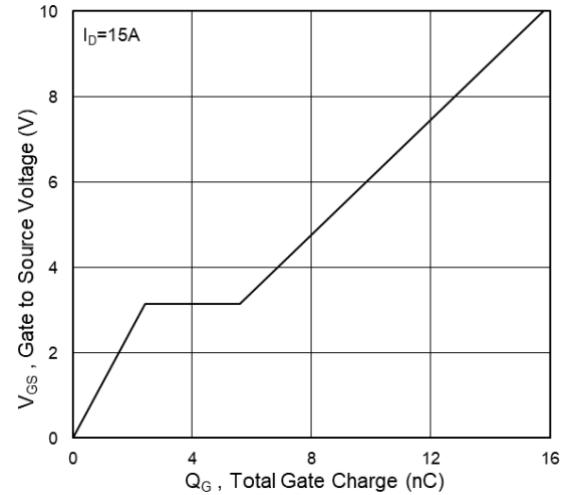

Fig.4 Gate-Charge Characteristics

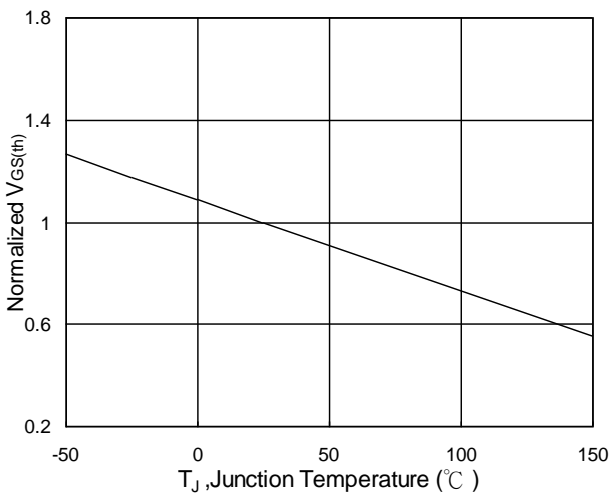

Fig.5 Normalized V_{GS(th)} vs T_J

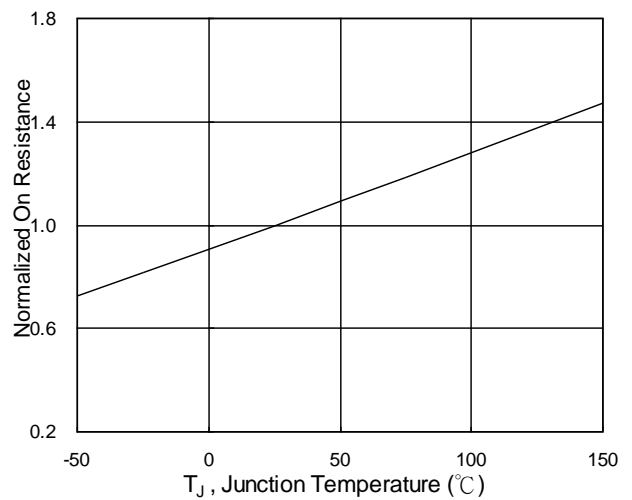

Fig.6 Normalized R_{DSON} vs T_J

N-Ch 30V Fast Switching MOSFETs

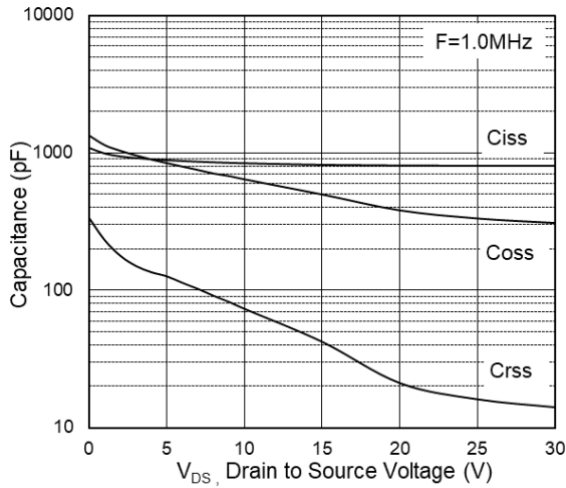

Fig.7 Capacitance

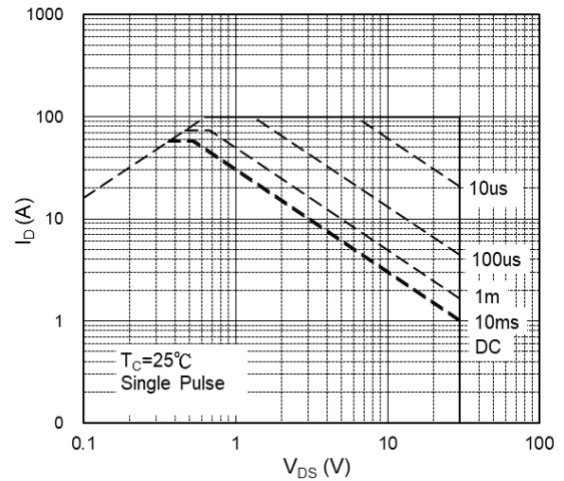

Fig.8 Safe Operating Area

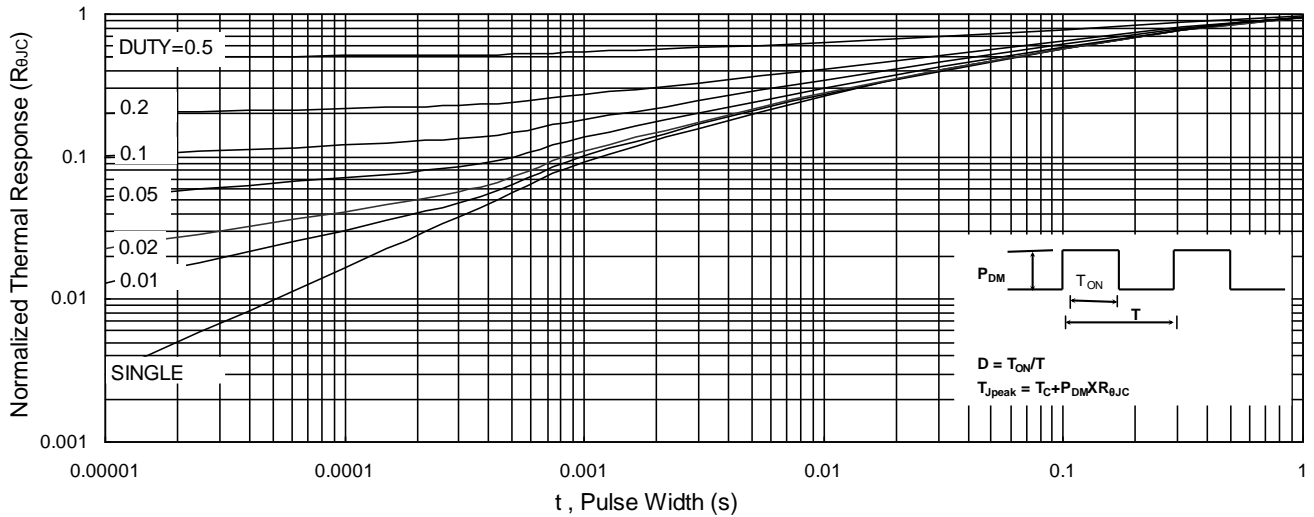

Fig.9 Normalized Maximum Transient Thermal Impedance

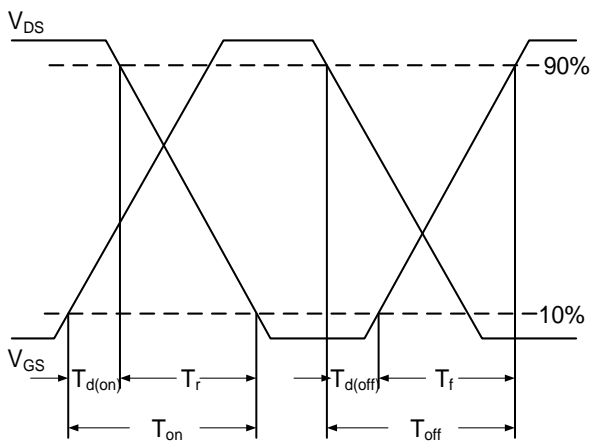

Fig.10 Switching Time Waveform

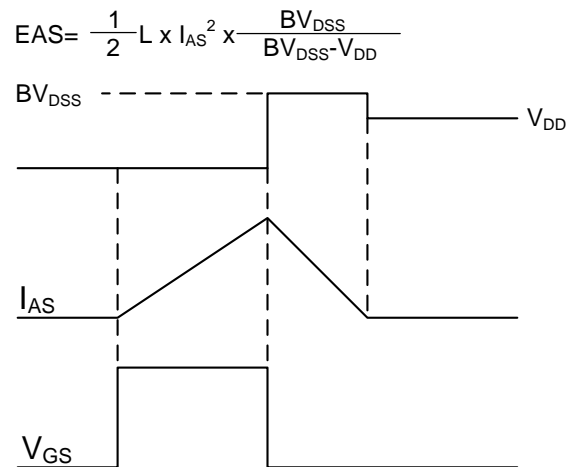

Fig.11 Unclamped Inductive Switching Waveform

X-ON Electronics

Largest Supplier of Electrical and Electronic Components

Click to view similar products for [MOSFET](#) category:

Click to view products by [HUASHUO](#) manufacturer:

Other Similar products are found below :

[614233C](#) [648584F](#) [MCH3443-TL-E](#) [MCH6422-TL-E](#) [FDPF9N50NZ](#) [FW216A-TL-2W](#) [FW231A-TL-E](#) [APT5010JVR](#) [NTNS3A92PZT5G](#)
[IRF100S201](#) [JANTX2N5237](#) [2SK2464-TL-E](#) [2SK3818-DL-E](#) [FCA20N60_F109](#) [FDZ595PZ](#) [STD6600NT4G](#) [FSS804-TL-E](#) [2SJ277-DL-E](#)
[2SK1691-DL-E](#) [2SK2545\(Q,T\)](#) [D2294UK](#) [405094E](#) [423220D](#) [MCH6646-TL-E](#) [TPCC8103,L1Q\(CM](#) [367-8430-0972-503](#) [VN1206L](#)
[424134F](#) [026935X](#) [051075F](#) [SBVS138LT1G](#) [614234A](#) [715780A](#) [NTNS3166NZT5G](#) [751625C](#) [873612G](#) [IRF7380TRHR](#)
[IPS70R2K0CEAKMA1](#) [RJK60S3DPP-E0#T2](#) [RJK60S5DPK-M0#T0](#) [APT5010JVFR](#) [APT12031JFLL](#) [APT12040JVR](#) [DMN3404LQ-7](#)
[NTE6400](#) [JANTX2N6796U](#) [JANTX2N6784U](#) [JANTXV2N5416U4](#) [SQM110N05-06L-GE3](#) [SIHF35N60E-GE3](#)