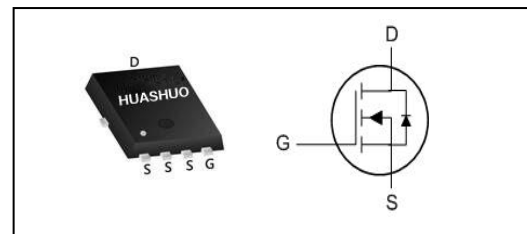

Description

- Advanced Trench Technology
 - Low Gate Charge
 - 100% UIS Tested
 - Low Gate Charge
-
- SMPS Synchronous Rectification
 - DC/DC Converters
 - Or-ing

Product Summary

V_{DS}	40	V
$R_{DS(ON),typ}$	4.7	m Ω
I_D	45	A

PRPAK3X3 Pin Configuration

Absolute Maximum Ratings

Symbol	Parameter	Rating	Units
V_{DS}	Drain-Source Voltage	40	V
V_{GS}	Gate-Source Voltage	± 20	V
$I_D@T_C=25^\circ\text{C}$	Continuous Drain Current ¹	45	A
$I_D@T_C=100^\circ\text{C}$	Continuous Drain Current ¹	31	A
I_{DM}	Pulsed Drain Current ²	80	A
EAS	Single Pulse Avalanche Energy ³	68	mJ
I_{AS}	Avalanche Current	37	A
$P_D@T_C=25^\circ\text{C}$	Total Power Dissipation ⁴	27	W
T_{STG}	Storage Temperature Range	-55 to 150	$^\circ\text{C}$
T_J	Operating Junction Temperature Range	-55 to 150	$^\circ\text{C}$

Thermal Data

Symbol	Parameter	Typ.	Max.	Unit
$R_{\theta JA}$	Thermal Resistance Junction-ambient (Steady State) ¹	---	60	$^\circ\text{C}/\text{W}$
$R_{\theta JC}$	Thermal Resistance Junction-Case ¹	---	4.5	$^\circ\text{C}/\text{W}$

Electrical Characteristics (T_J=25 °C, unless otherwise noted)

Symbol	Parameter	Conditions	Min.	Typ.	Max.	Unit
BV _{DSS}	Drain-Source Breakdown Voltage	V _{GS} =0V, I _D =250uA	40	---	---	V
R _{DS(ON)}	Static Drain-Source On-Resistance ²	V _{GS} =10V, I _D =15A	---	4.7	6.5	mΩ
		V _{GS} =4.5V, I _D =15A	---	7.5	10.5	
V _{GS(th)}	Gate Threshold Voltage	V _{GS} =V _{DS} , I _D =250uA	1.2	1.9	2.2	V
I _{DSS}	Drain-Source Leakage Current	V _{DS} =32V, V _{GS} =0V, T _J =25°C	---	---	1	uA
		V _{DS} =32V, V _{GS} =0V, T _J =55°C	---	---	5	
I _{GSS}	Gate-Source Leakage Current	V _{GS} = ± 20V, V _{DS} =0V	---	---	± 100	nA
R _g	Gate Resistance	V _{DS} =0V, V _{GS} =0V, f=1MHz	---	1.9	---	Ω
Q _g	Total Gate Charge	V _{DS} =20V, V _{GS} =10V, I _D =15A	---	20	---	nC
Q _{gs}	Gate-Source Charge		---	3.5	---	
Q _{gd}	Gate-Drain Charge		---	4.2	---	
T _{d(on)}	Turn-On Delay Time	V _{DD} =20V, V _{GS} =10V, R _G =3Ω I _D =15A	---	12	---	ns
T _r	Rise Time		---	9.6	---	
T _{d(off)}	Turn-Off Delay Time		---	21	---	
T _f	Fall Time		---	16	---	
C _{iss}	Input Capacitance	V _{DS} =20V, V _{GS} =0V, f=1MHz	---	950	---	pF
C _{oss}	Output Capacitance		---	493	---	
C _{rss}	Reverse Transfer Capacitance		---	48	---	

Diode Characteristics

Symbol	Parameter	Conditions	Min.	Typ.	Max.	Unit
I _S	Continuous Source Current ^{1,5}	V _G =V _D =0V, Force Current	---	---	45	A
V _{SD}	Diode Forward Voltage ²	V _{GS} =0V, I _S =1A, T _J =25°C	---	---	1.2	V

Note :

- 1.The data tested by surface mounted on a 1 inch² FR-4 board with 2OZ copper.
- 2.The data tested by pulsed , pulse width ≤ 300us , duty cycle ≤ 2%
- 3.The EAS data shows Max. rating . The test condition is V_{DD}=25V, V_{GS}=10V, L=0.1mH, I_{AS}=37A
- 4.The power dissipation is limited by 150°C junction temperature
- 5.The data is theoretically the same as I_D and I_{DM} , in real applications , should be limited by total power dissipation.



Typical Characteristics

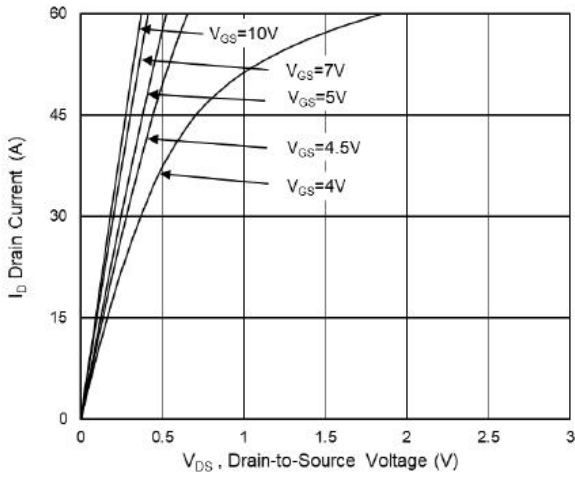

Fig.1 Typical Output Characteristics

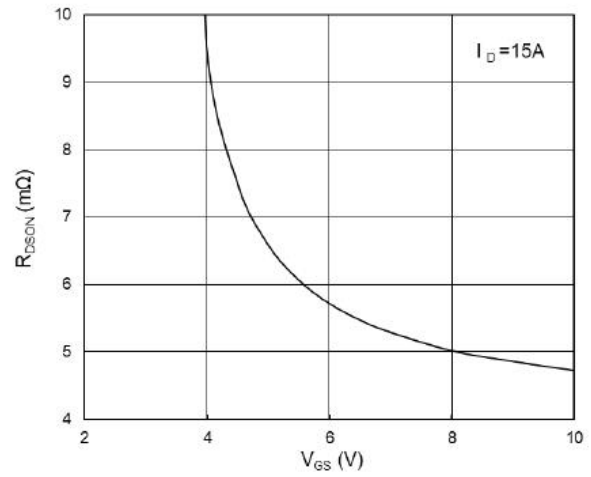

Fig.2 On-Resistance vs. G-S Voltage

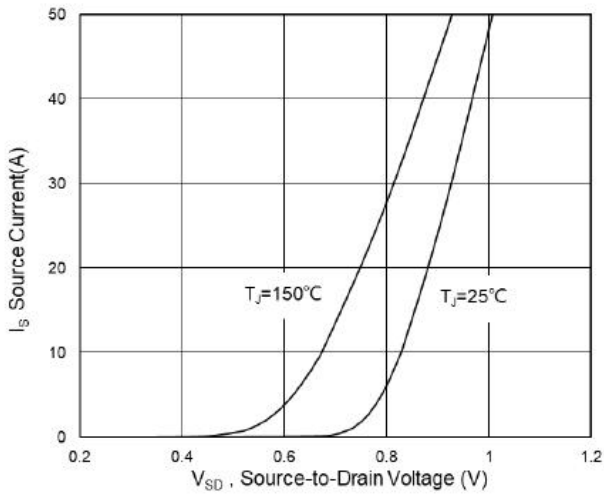

Fig.3 Source Drain Forward Characteristics

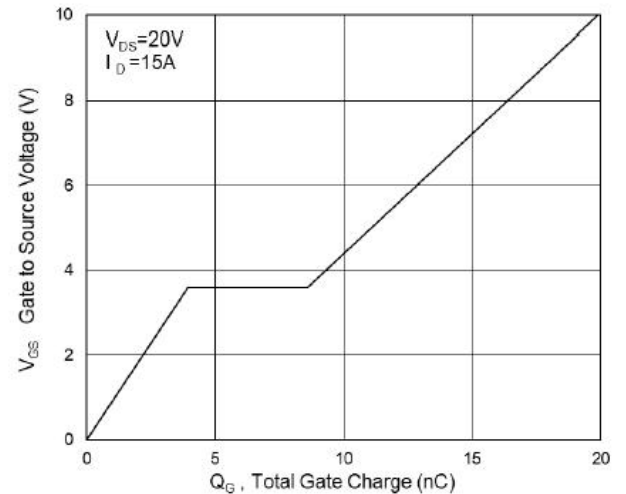

Fig.4 Gate-Charge Characteristics

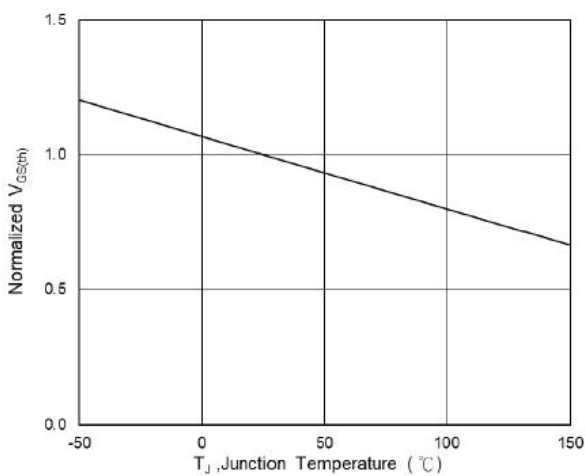

Fig.5 Normalized $V_{GS(th)}$ vs. T_J

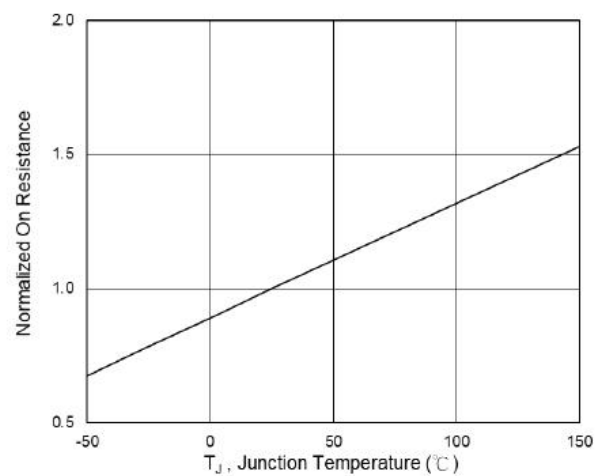

Fig.6 Normalized $R_{DS(on)}$ vs. T_J

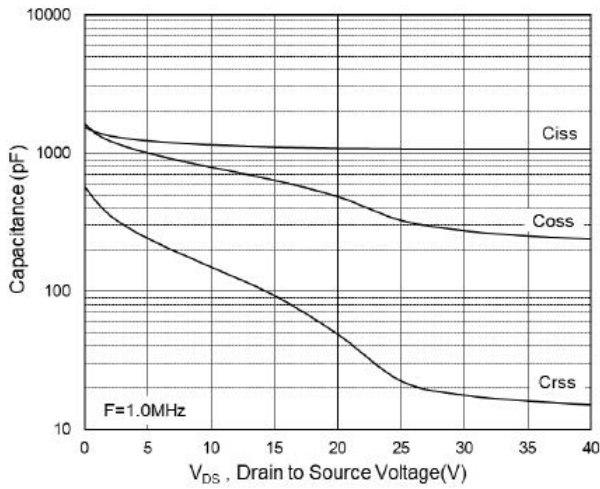

Fig.7 Capacitance

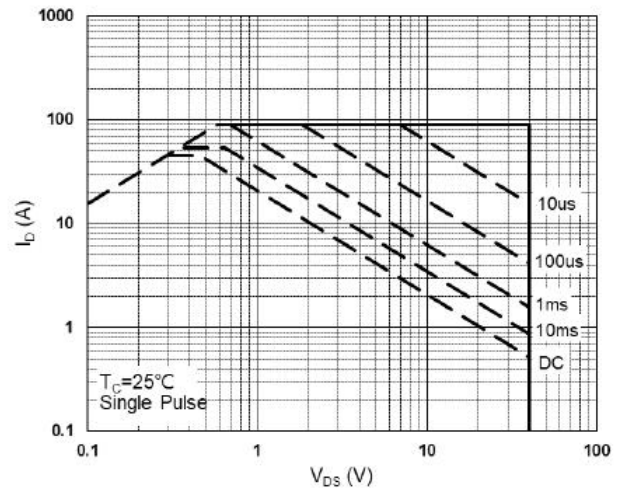

Fig.8 Safe Operating Area

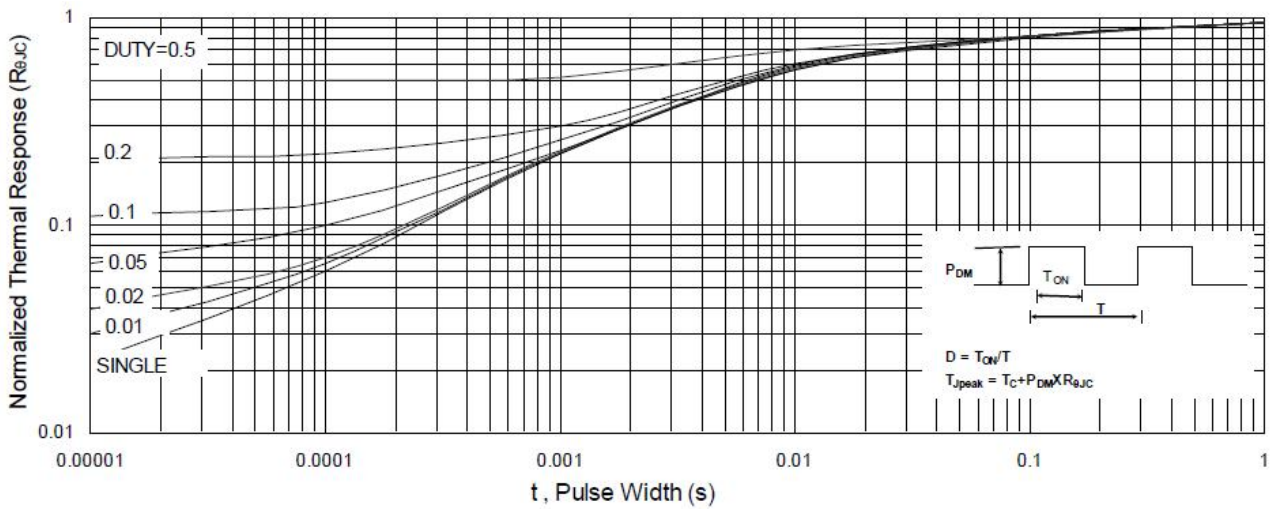

Fig.9 Normalized Maximum Transient Thermal Impedance

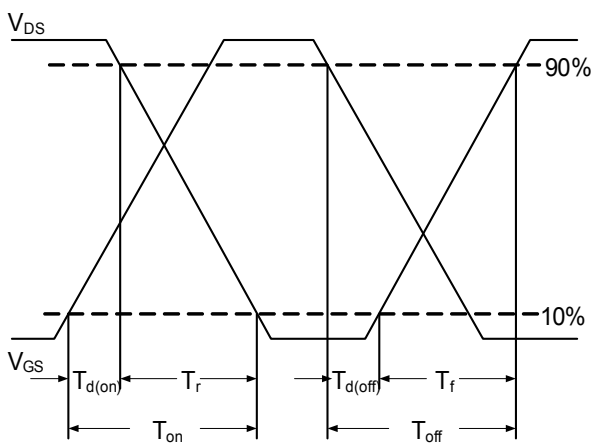

Fig.10 Switching Time Waveform

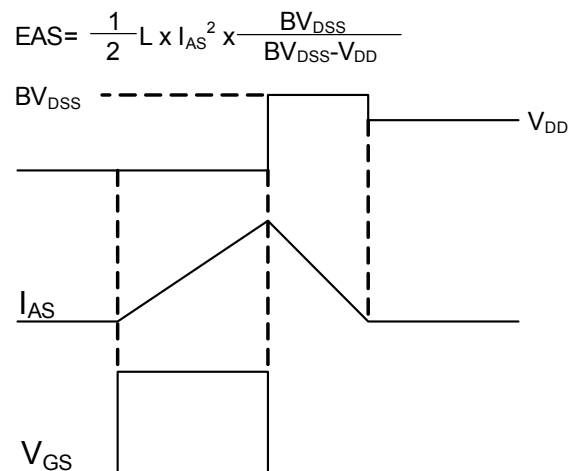
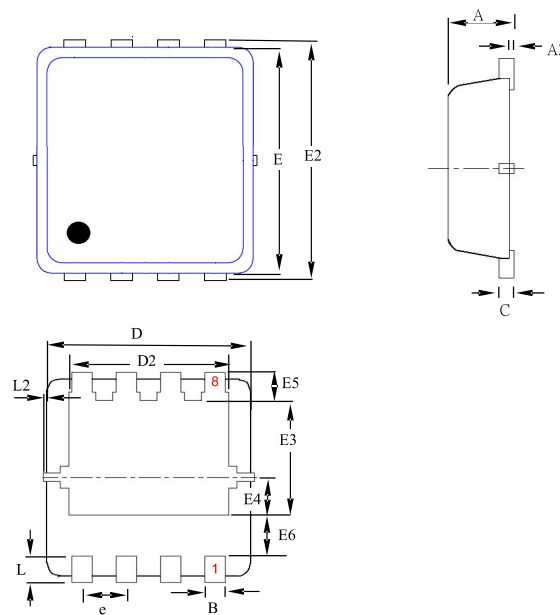

Fig.11 Unclamped Inductive Waveform

Ordering Information

Part Number	Package code	Packaging
HSBB4054	PRPAK3*3	3000/Tape&Reel

PRPAK 3*3(E) Single Outline



SYMBOLS	MILLIMETERS			INCHES		
	MIN	NOM	MAX	MIN	NOM	MAX
A	0.70	0.80	0.90	0.028	0.031	0.035
A2	0.00	--	0.05	0.000	--	0.002
B	0.24	0.30	0.35	0.009	0.012	0.014
C	0.10	0.15	0.25	0.004	0.006	0.010
D	2.90	3.00	3.20	0.114	0.118	0.126
D2	2.15	2.35	2.59	0.085	0.093	0.102
E	2.90	3.00	3.12	0.114	0.118	0.123
E2	3.05	3.20	3.45	0.120	0.126	0.136
E3	1.55	1.75	1.95	0.061	0.069	0.077
E4	0.48	0.58	0.68	0.019	0.023	0.027
E5	0.28	0.43	0.58	0.011	0.017	0.023
E6	0.43	0.63	0.87	0.017	0.025	0.034
L	0.30	0.40	0.50	0.012	0.016	0.020
L2	0.00	--	0.10	0.000	--	0.004
e	--	0.65	--	--	0.026	--

X-ON Electronics

Largest Supplier of Electrical and Electronic Components

Click to view similar products for [MOSFET](#) category:

Click to view products by [HUASHUO](#) manufacturer:

Other Similar products are found below :

[IRFD120](#) [JANTX2N5237](#) [BUK455-60A/B](#) [MIC4420CM-TR](#) [VN1206L](#) [NDP4060](#) [SI4482DY](#) [IPS70R2K0CEAKMA1](#) [SQD23N06-31L-GE3](#)
[TK16J60W,S1VQ\(O](#) [2SK2614\(TE16L1,Q\)](#) [DMN1017UCP3-7](#) [DMN1053UCP4-7](#) [SQJ469EP-T1-GE3](#) [NTE2384](#) [DMC2700UDMQ-7](#)
[DMN2080UCB4-7](#) [DMN61D9UWQ-13](#) [US6M2GTR](#) [DMN31D5UDJ-7](#) [DMP22D4UFO-7B](#) [DMN1006UCA6-7](#) [DMN16M9UCA6-7](#)
[STF5N65M6](#) [IRF40H233XTMA1](#) [STU5N65M6](#) [DMN6022SSD-13](#) [DMN13M9UCA6-7](#) [DMTH10H4M6SPS-13](#) [DMN2990UFB-7B](#)
[IPB80P04P405ATMA2](#) [2N7002W-G](#) [MCAC30N06Y-TP](#) [MCQ7328-TP](#) [BXP7N65D](#) [BXP4N65F](#) [AOL1454G](#) [WMJ80N60C4](#) [BXP2N20L](#)
[BXP2N65D](#) [BXT1150N10J](#) [BXT1700P06M](#) [TSM60NB380CP](#) [ROG](#) [RQ7L055BGTCR](#) [DMNH15H110SK3-13](#) [SLF10N65ABV2](#)
[BSO203SP](#) [BSO211P](#) [IPA60R230P6](#) [IPA60R460CE](#)