

Description

The HSH80N20 is the highest performance trench N-ch MOSFETs with extreme high cell density, which provide excellent $R_{DS(ON)}$ and gate charge for most of the synchronous buck converter applications.

The HSH80N20 meet the RoHS and Green Product requirement, 100% EAS guaranteed with full function reliability approved.

- Power Switching application
- Green Device Available
- Excellent Cdv/dt effect decline
- Advanced high cell density Trench technology

Product Summary

V_{DS}	200	V
$R_{DS(ON),typ}$	20	m Ω
I_D	80	A

TO263 Pin Configuration

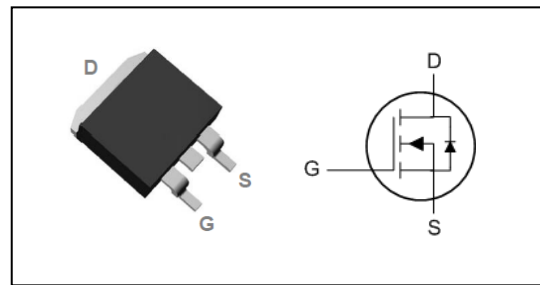

Absolute Maximum Ratings

Symbol	Parameter	Rating	Units
V_{DS}	Drain-Source Voltage	200	V
V_{GS}	Gate-Source Voltage	± 20	V
$I_D@T_C=25^\circ C$	Continuous Drain Current, V_{GS} @ 10V ¹	80	A
$I_D@T_C=100^\circ C$	Continuous Drain Current, V_{GS} @ 10V ¹	55	A
I_{DM}	Pulsed Drain Current ²	280	A
EAS	Single Pulse Avalanche Energy ³	400	mJ
$P_D@T_C=25^\circ C$	Total Power Dissipation ³	370	W
T_{STG}	Storage Temperature Range	-55 to 150	$^\circ C$
T_J	Operating Junction Temperature Range	-55 to 150	$^\circ C$

Thermal Data

Symbol	Parameter	Typ.	Max.	Unit
$R_{\theta JA}$	Thermal Resistance Junction-ambient ¹	---	62	$^\circ C/W$
$R_{\theta JC}$	Thermal Resistance Junction-Case ¹	---	0.45	$^\circ C/W$



N-Ch 200V Fast Switching MOSFETs

Electrical Characteristics (T_J=25 °C, unless otherwise noted)

Symbol	Parameter	Conditions	Min.	Typ.	Max.	Unit
BV _{DSS}	Drain-Source Breakdown Voltage	V _{GS} =0V, I _D =250uA	200	---	---	V
R _{DS(ON)}	Static Drain-Source On-Resistance ²	V _{GS} =10V, I _D =30A	---	20	24	mΩ
V _{GS(th)}	Gate Threshold Voltage	V _{GS} =V _{DS} , I _D =250uA	2	3.3	4	V
I _{DSS}	Drain-Source Leakage Current	V _{DS} =200V, V _{GS} =0V, T _J =25°C	---	---	1	uA
		V _{DS} =200V, V _{GS} =0V, T _J =55°C	---	---	5	
I _{GSS}	Gate-Source Leakage Current	V _{GS} =±20V, V _{DS} =0V	---	---	±100	nA
R _g	Gate Resistance	V _{DS} =0V, V _{GS} =0V, f=1MHz	---	1.1	---	Ω
Q _g	Total Gate Charge (10V)	V _{DS} =100V, V _{GS} =10V, I _D =30A	---	115	---	nC
Q _{gs}	Gate-Source Charge		---	32	---	
Q _{gd}	Gate-Drain Charge		---	20.3	---	
T _{d(on)}	Turn-On Delay Time	V _{DD} =100V, V _{GS} =10V, R _G =2.5Ω I _D =30A	---	27	---	ns
T _r	Rise Time		---	38	---	
T _{d(off)}	Turn-Off Delay Time		---	22	---	
T _f	Fall Time		---	23	---	
C _{iss}	Input Capacitance	V _{DS} =50V, V _{GS} =0V, f=1MHz	---	7490	---	pF
C _{oss}	Output Capacitance		---	267	---	
C _{riss}	Reverse Transfer Capacitance		---	37	---	

Diode Characteristics

Symbol	Parameter	Conditions	Min.	Typ.	Max.	Unit
I _S	Continuous Source Current ^{1,5}	V _G =V _D =0V, Force Current	---	---	80	A
I _{SM}	Pulsed Source Current ^{2,5}		---	---	280	A
V _{SD}	Diode Forward Voltage ²	V _{GS} =0V, I _S =30A, T _J =25°C	---	---	1.2	V

Note :

- 1.The data tested by surface mounted on a 1 inch² FR-4 board with 2OZ copper.
- 2.The data tested by pulsed , pulse width ≤ 300us , duty cycle ≤ 2%
- 3.The EAS data shows Max. rating . The test condition is V_{DD}=25V, V_{GS}=10V, L=0.5mH
- 4.The power dissipation is limited by 150°C junction temperature
- 5.The data is theoretically the same as I_D and I_{DM} , in real applications , should be limited by total power dissipation.



Typical Characteristics

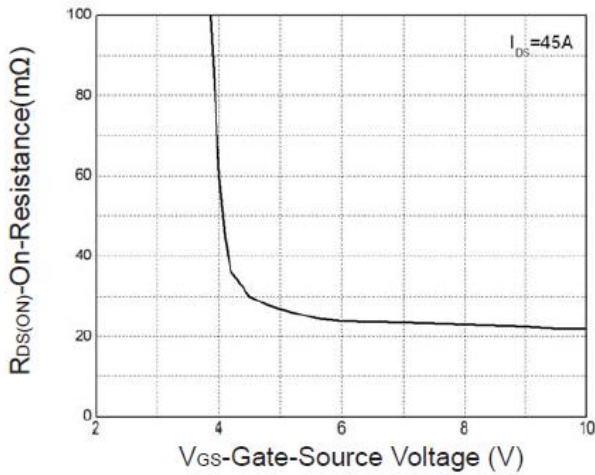

Fig.1 Gate-Source Vs.On-Resistance

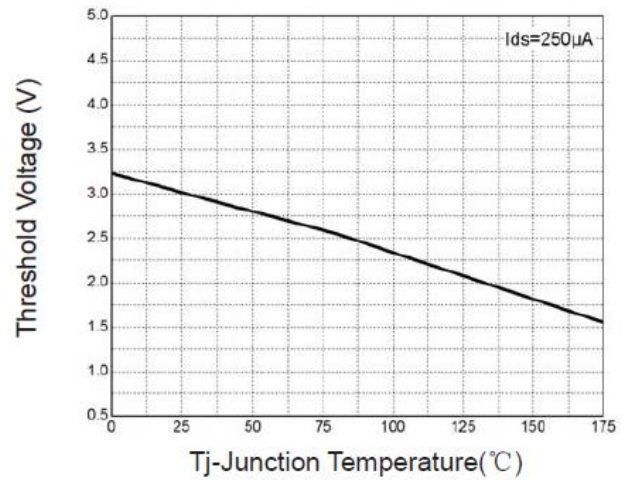

Fig.2 Gate-Source Forward

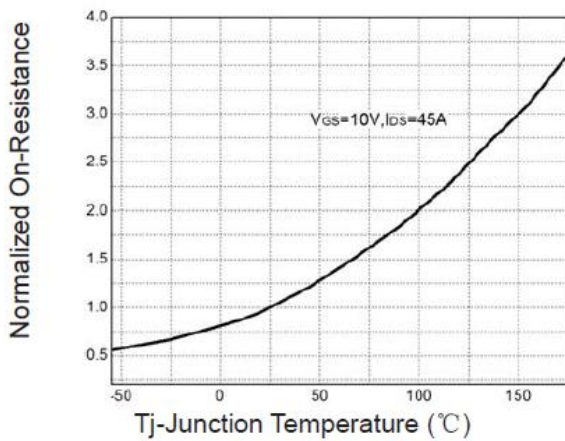

Fig.3 On-Resistance VS.Temperature

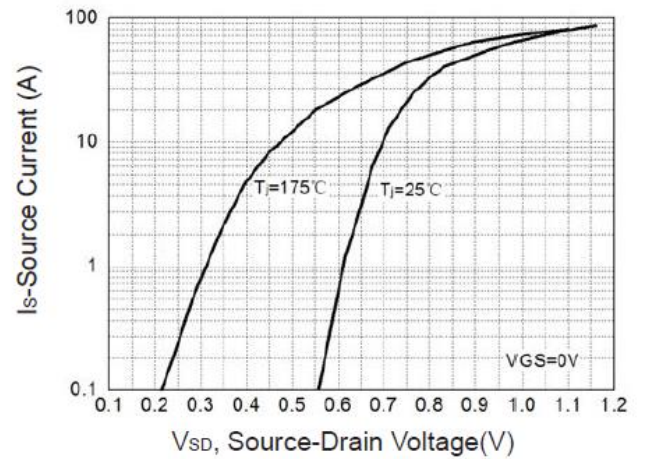

Fig.4 Source-Drain Diode Forward

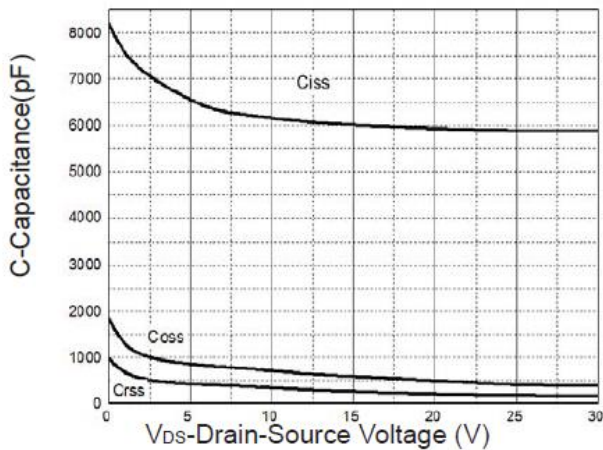

Fig.5 Capacitance Characteristics

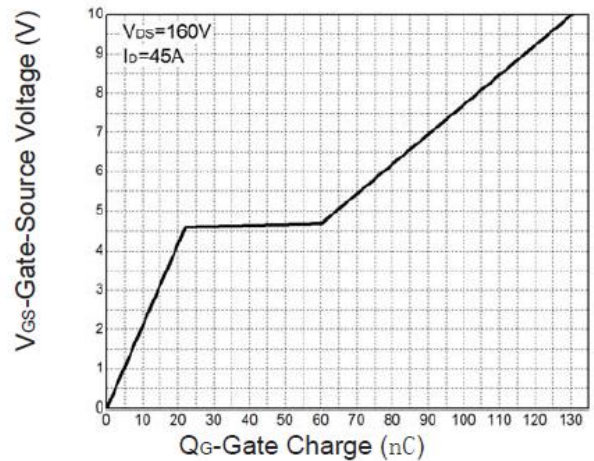

Fig.6 Gate Charge Characteristics



N-Ch 200V Fast Switching MOSFETs

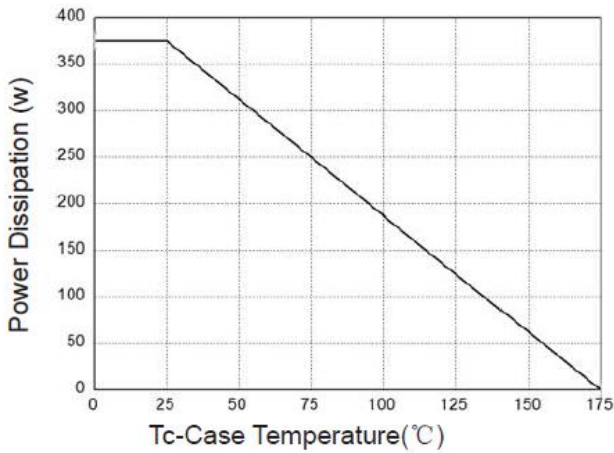

Fig.7 Power Dissipation

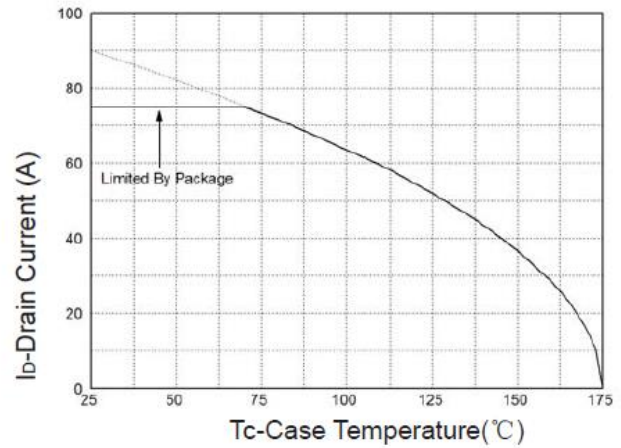

Fig.8 Drain Current

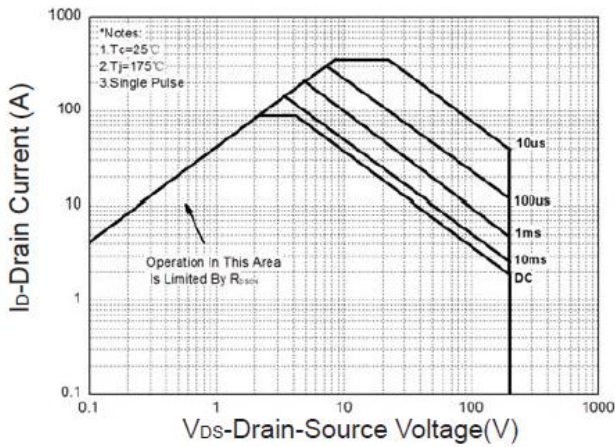
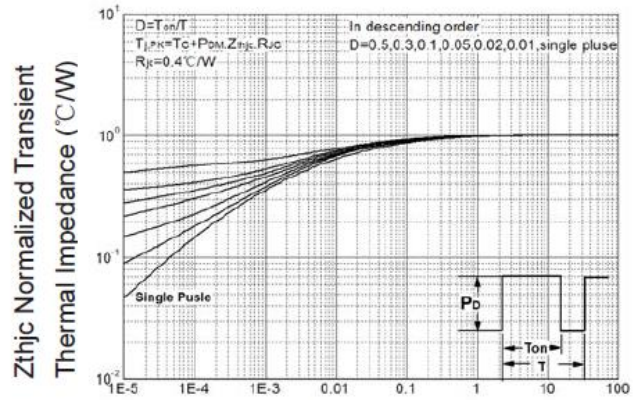

Fig.9 Safe Operation Area



Maximum Effective Transient Thermal Impedance, Junction-to-Case

Fig.10 Thermal Transient Impedance

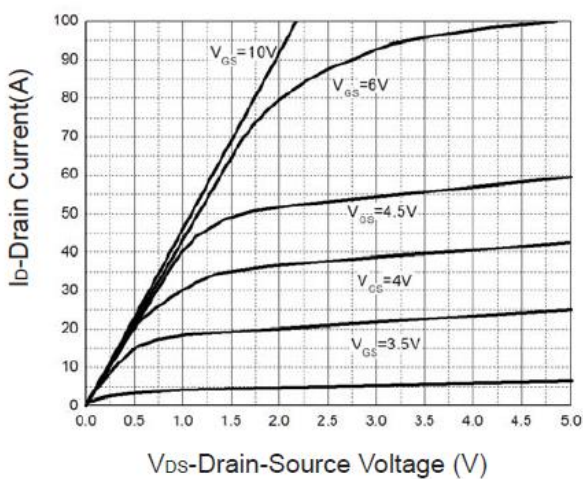

Fig.11 Output Characteristics

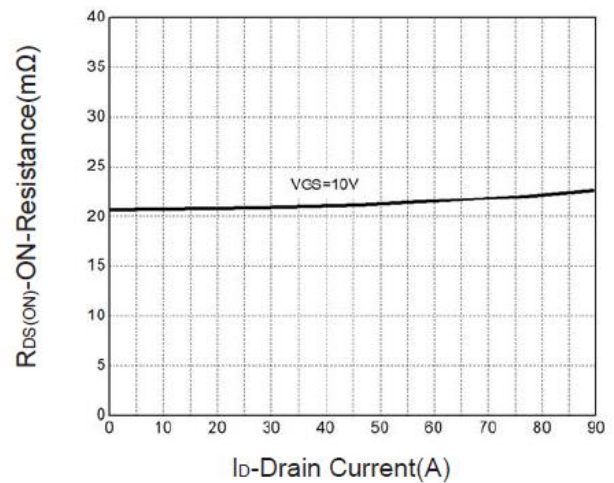
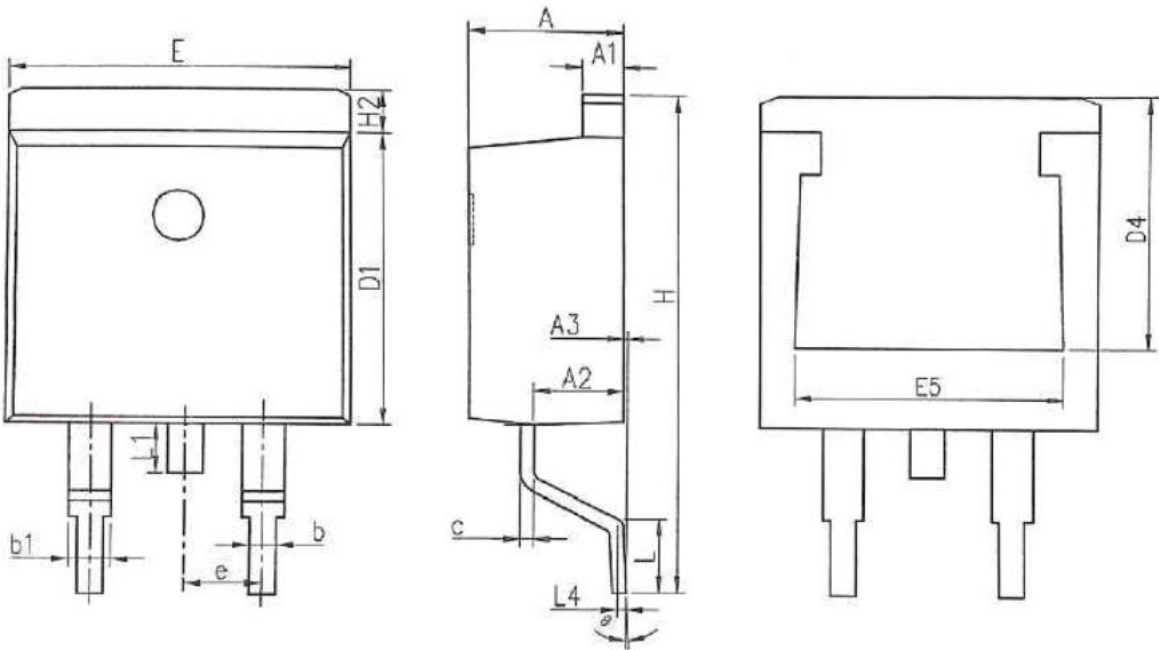

Fig.12 Drain-Source On Resistance



SYMBOLS	MILLIMETERS		INCHES	
	MIN	MAX	MIN	MAX
A	4.370	4.770	0.172	0.188
A1	1.220	1.420	0.048	0.056
A2	2.200	2.890	0.087	0.114
A3	0.000	0.250	0.000	0.010
b	0.700	0.960	0.028	0.038
b1	1.170	1.470	0.046	0.058
c	0.300	0.530	0.012	0.021
D1	8.500	9.300	0.335	0.366
D4	6.600	-	0.260	-
E	9.860	10.36	0.388	0.408
E5	7.060	-	0.278	-
e	2.540 BSC		0.100 BSC	
H	14.70	15.70	0.579	0.618
H2	1.070	1.470	0.042	0.058
L	2.000	2.600	0.079	0.102
L1	1.400	1.750	0.055	0.069
L4	0.250 BSC		0.010 BSC	
Θ	0°	9°	0°	9°

X-ON Electronics

Largest Supplier of Electrical and Electronic Components

Click to view similar products for [MOSFET](#) category:

Click to view products by [HUASHUO](#) manufacturer:

Other Similar products are found below :

[IRFD120](#) [JANTX2N5237](#) [2SK2267\(Q\)](#) [BUK455-60A/B](#) [TK100A10N1,S4X\(S](#) [MIC4420CM-TR](#) [VN1206L](#) [NDP4060](#) [SI4482DY](#)
[IRS2092STRPBF-EL](#) [IPS70R2K0CEAKMA1](#) [TK31J60W5,S1VQ\(O](#) [TK31J60W,S1VQ\(O](#) [TK16J60W,S1VQ\(O](#) [2SK2614\(TE16L1,Q\)](#)
[DMN1017UCP3-7](#) [EFC2J004NUZTDG](#) [P85W28HP2F-7071](#) [DMN1053UCP4-7](#) [NTE2384](#) [DMC2700UDMQ-7](#) [DMN2080UCB4-7](#)
[DMN61D9UWQ-13](#) [US6M2GTR](#) [DMN31D5UDJ-7](#) [DMP22D4UFO-7B](#) [IPS60R3K4CEAKMA1](#) [DMN1006UCA6-7](#) [DMN16M9UCA6-7](#)
[STF5N65M6](#) [IRF40H233XTMA1](#) [STU5N65M6](#) [DMN6022SSD-13](#) [DMN13M9UCA6-7](#) [DMTH10H4M6SPS-13](#) [IPS60R360PFD7SAKMA1](#)
[DMN2990UFB-7B](#) [SSM3K35CT,L3F](#) [IPLK60R1K0PFD7ATMA1](#) [2N7002W-G](#) [MCAC30N06Y-TP](#) [IPWS65R035CFD7AXKSA1](#)
[MCQ7328-TP](#) [SSM3J143TU,LXHF](#) [DMN12M3UCA6-7](#) [PJMF280N65E1_T0_00201](#) [PJMF380N65E1_T0_00201](#)
[PJMF280N60E1_T0_00201](#) [PJMF600N65E1_T0_00201](#) [PJMF900N65E1_T0_00201](#)