

**Description**

The HSH8119 is the high cell density trenched P-ch MOSFETs, which provide excellent RDSON and gate charge for most of the synchronous buck converter applications. The HSH8119 meet the RoHS and Green Product requirement, 100% EAS guaranteed with full function reliability approved.

- Super Low Gate Charge
- 100% EAS Guaranteed
- Green Device Available
- Excellent CdV/dt effect decline
- Advanced high cell density Trench technology

**Product Summary**

$V_{DS}$	-80	V
$R_{DS(ON),typ}$	13.5	m $\Omega$
$I_D$	-90	A

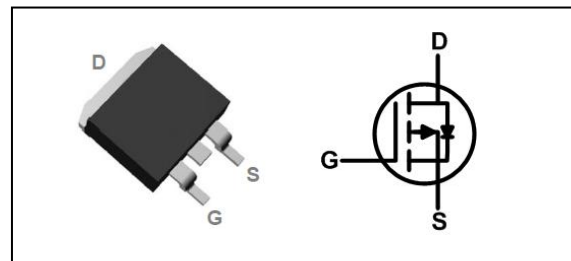
**TO-263 Pin Configuration**

**Absolute Maximum Ratings**

Symbol	Parameter	Rating	Units
$V_{DS}$	Drain-Source Voltage	-80	V
$V_{GS}$	Gate-Source Voltage	$\pm 20$	V
$I_D@T_C=25^\circ C$	Continuous Drain Current, $-V_{GS} @ -10V^1$	-90	A
$I_D@T_C=100^\circ C$	Continuous Drain Current, $-V_{GS} @ -10V^1$	-60	A
$I_{DM}$	Pulsed Drain Current <sup>2</sup>	-270	A
EAS	Single Pulse Avalanche Energy <sup>3</sup>	710	mJ
$I_{AS}$	Avalanche Current	63	A
$P_D@T_C=25^\circ C$	Total Power Dissipation <sup>4</sup>	210	W
$T_{STG}$	Storage Temperature Range	-55 to 150	$^\circ C$
$T_J$	Operating Junction Temperature Range	-55 to 150	$^\circ C$

**Thermal Data**

Symbol	Parameter	Typ.	Max.	Unit
$R_{\theta JA}$	Thermal Resistance Junction-Ambient <sup>1</sup>	---	62	$^\circ C/W$
$R_{\theta JC}$	Thermal Resistance Junction-Case <sup>1</sup>	---	0.73	$^\circ C/W$



**Electrical Characteristics (T<sub>J</sub>=25 °C, unless otherwise noted)**

Symbol	Parameter	Conditions	Min.	Typ.	Max.	Unit
BV <sub>DSS</sub>	Drain-Source Breakdown Voltage	V <sub>GS</sub> =0V , I <sub>D</sub> =-250uA	-80	---	---	V
R <sub>DS(ON)</sub>	Static Drain-Source On-Resistance <sup>2</sup>	V <sub>GS</sub> =-10V , I <sub>D</sub> =-20A	---	13.5	15	mΩ
		V <sub>GS</sub> =-4.5V , I <sub>D</sub> =-10A	---	14.5	17	
V <sub>GS(th)</sub>	Gate Threshold Voltage	V <sub>GS</sub> =V <sub>DS</sub> , I <sub>D</sub> =-250uA	-1.0	-1.8	-2.5	V
I <sub>DSS</sub>	Drain-Source Leakage Current	V <sub>DS</sub> =-80V , V <sub>GS</sub> =0V , T <sub>J</sub> =25°C	---	---	1	uA
		V <sub>DS</sub> =-80V , V <sub>GS</sub> =0V , T <sub>J</sub> =55°C	---	---	10	
I <sub>GSS</sub>	Gate-Source Leakage Current	V <sub>GS</sub> = ± 20V , V <sub>DS</sub> =0V	---	---	± 100	nA
R <sub>g</sub>	Gate Resistance	V <sub>GS</sub> =0V , V <sub>DS</sub> =0V , f=1.0MHz	---	1.7	---	Ω
g <sub>fs</sub>	Forward Transconductance	V <sub>DS</sub> =-10V , I <sub>D</sub> =-3A	---	30	---	S
Q <sub>g</sub>	Total Gate Charge	V <sub>DS</sub> =-40V , V <sub>GS</sub> =-10V , I <sub>D</sub> =-10A	---	190	---	nC
Q <sub>gs</sub>	Gate-Source Charge		---	29	---	
Q <sub>gd</sub>	Gate-Drain Charge		---	55	---	
T <sub>d(on)</sub>	Turn-On Delay Time	V <sub>DD</sub> =-40V , V <sub>GS</sub> =-10V , R <sub>G</sub> =6Ω , I <sub>D</sub> =-10A	---	25	---	ns
T <sub>r</sub>	Rise Time		---	20	---	
T <sub>d(off)</sub>	Turn-Off Delay Time		---	180	---	
T <sub>f</sub>	Fall Time		---	88	---	
C <sub>iss</sub>	Input Capacitance	V <sub>DS</sub> =-40V , V <sub>GS</sub> =0V , f=1MHz	---	13300	---	pF
C <sub>oss</sub>	Output Capacitance		---	390	---	
C <sub>rss</sub>	Reverse Transfer Capacitance		---	50	---	

**Diode Characteristics**

Symbol	Parameter	Conditions	Min.	Typ.	Max.	Unit
I <sub>S</sub>	Continuous Source Current <sup>1,5</sup>	V <sub>G</sub> =V <sub>D</sub> =0V , Force Current	---	---	-90	A
I <sub>SM</sub>	Pulsed Source Current <sup>2,5</sup>		---	---	-270	A
V <sub>SD</sub>	Diode Forward Voltage <sup>2</sup>	V <sub>GS</sub> =0V , I <sub>S</sub> =-1A , T <sub>J</sub> =25°C	---	---	-1.2	V
T <sub>rr</sub>	Reverse Recovery Time	I <sub>F</sub> =-20A , di/dt=100A/μs	---	35	---	ns
Q <sub>rr</sub>	Reverse Recovery Charge	I <sub>F</sub> =-20A , di/dt=100A/μs	---	45	---	nC

**Note :**

- 1.The data tested by surface mounted on a 1 inch<sup>2</sup> FR-4 board with 2OZ copper.
- 2.The data tested by pulsed , pulse width ≤ 300us , duty cycle ≤ 2%
- 3.The EAS data shows Max. rating . The test condition is V<sub>DD</sub>=-50V,V<sub>GS</sub>=-10V,L=0.1mH,R<sub>G</sub>=25Ω,I<sub>AS</sub>=-63A
- 4.The power dissipation is limited by 150°C junction temperature
- 5.The data is theoretically the same as I<sub>D</sub> and I<sub>DM</sub> , in real applications , should be limited by total power dissipation.



**Typical Characteristics**

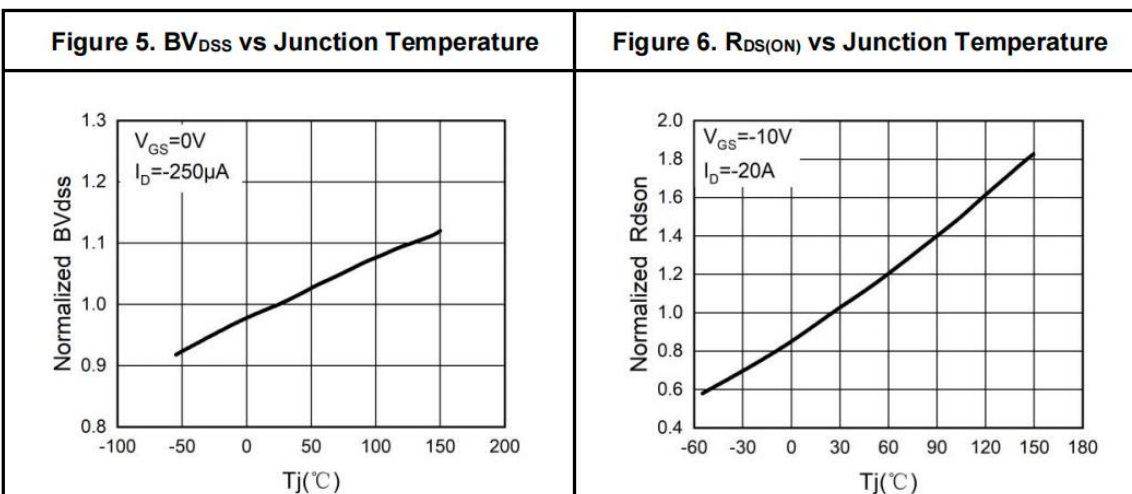
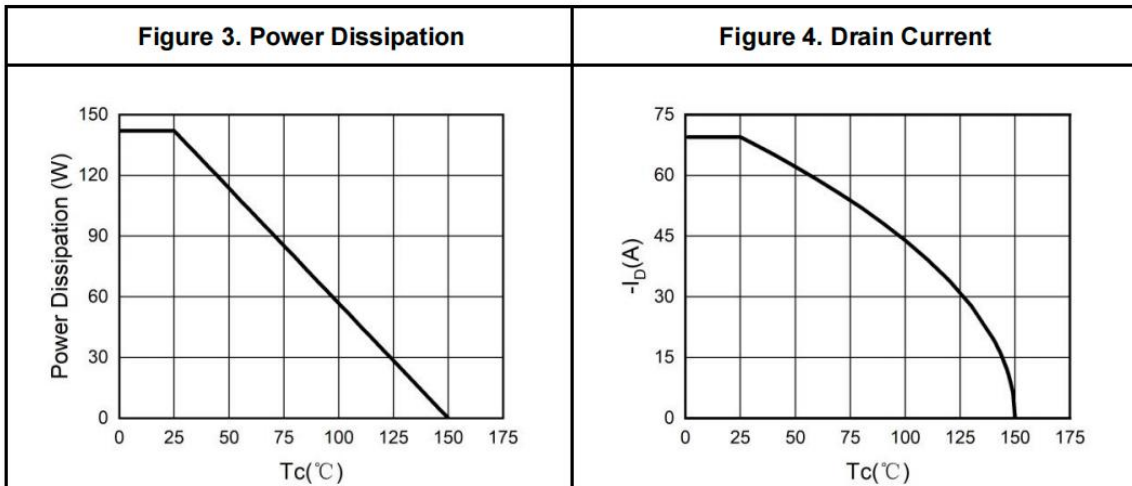
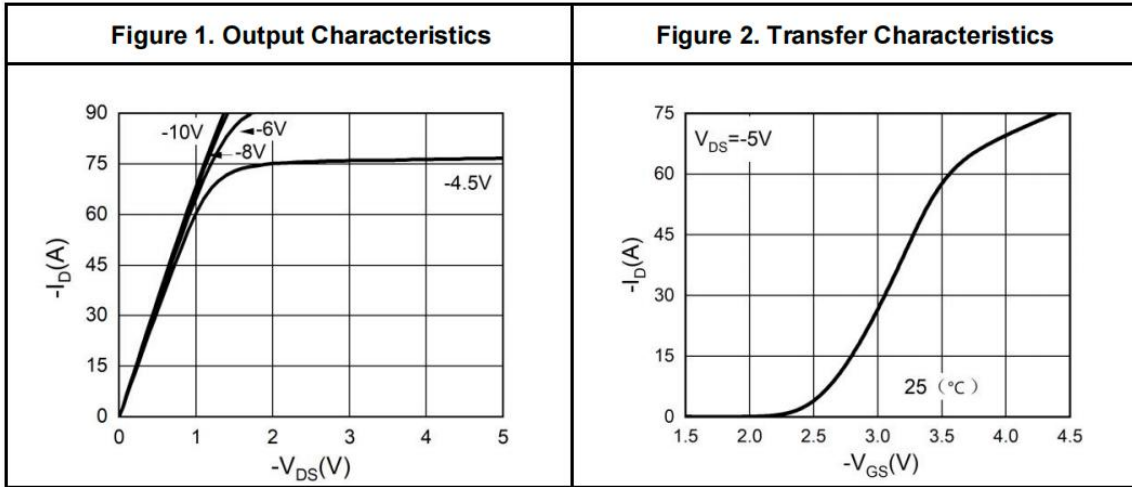

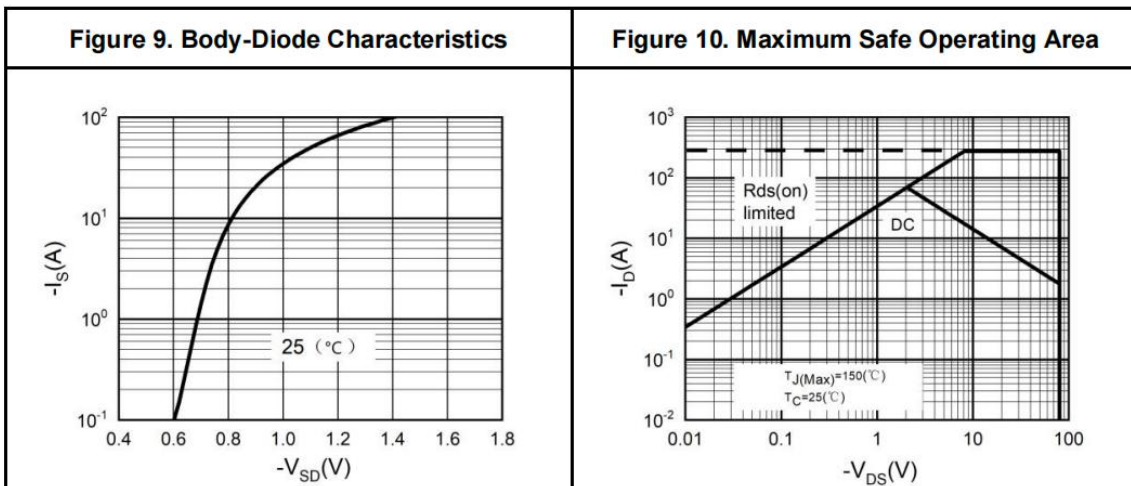
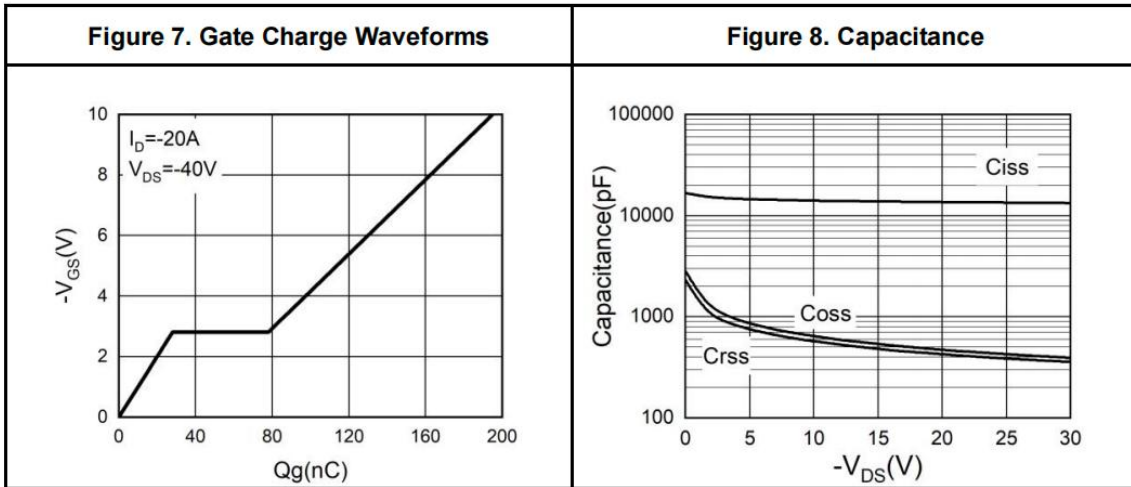

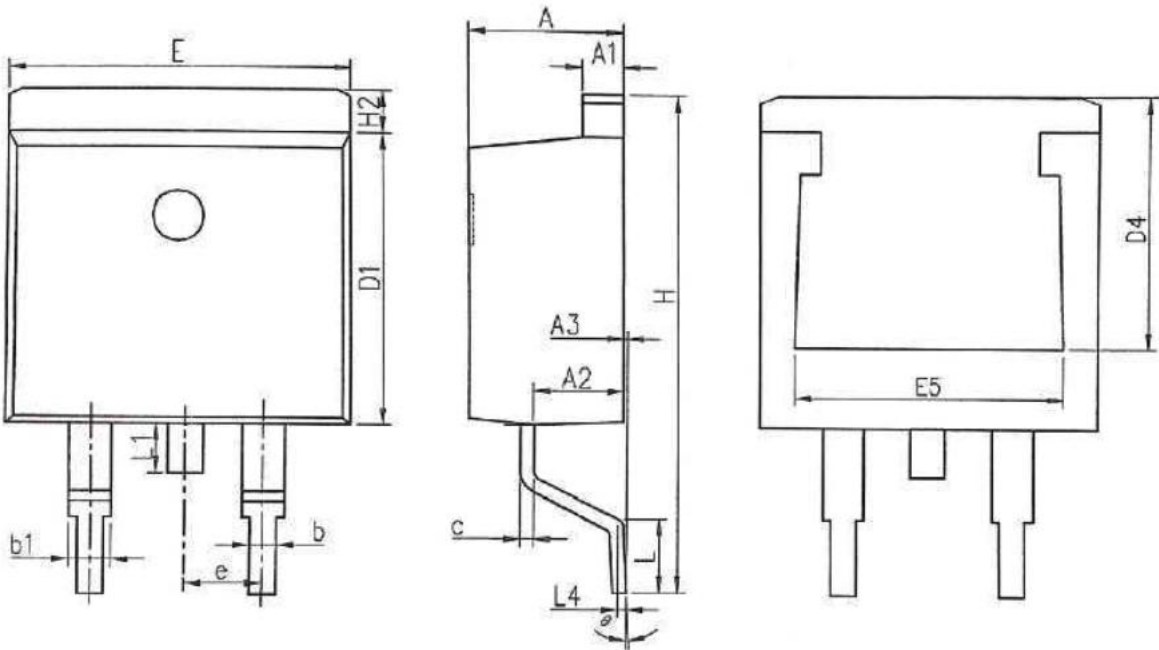

SYMBOLS	MILLIMETERS		INCHES	
	MIN	MAX	MIN	MAX
A	4.370	4.770	0.172	0.188
A1	1.220	1.420	0.048	0.056
A2	2.200	2.890	0.087	0.114
A3	0.000	0.250	0.000	0.010
b	0.700	0.960	0.028	0.038
b1	1.170	1.470	0.046	0.058
c	0.300	0.530	0.012	0.021
D1	8.500	9.300	0.335	0.366
D4	6.600	-	0.260	-
E	9.860	10.36	0.388	0.408
E5	7.060	-	0.278	-
e	2.540 BSC		0.100 BSC	
H	14.70	15.70	0.579	0.618
H2	1.070	1.470	0.042	0.058
L	2.000	2.600	0.079	0.102
L1	1.400	1.750	0.055	0.069
L4	0.250 BSC		0.010 BSC	
∅	0°	9°	0°	9°

## X-ON Electronics

Largest Supplier of Electrical and Electronic Components

*Click to view similar products for [MOSFET](#) category:*

*Click to view products by [HUASHUO](#) manufacturer:*

Other Similar products are found below :

[IRFD120](#) [JANTX2N5237](#) [BUK455-60A/B](#) [MIC4420CM-TR](#) [VN1206L](#) [NDP4060](#) [SI4482DY](#) [IPS70R2K0CEAKMA1](#) [SQD23N06-31L-GE3](#)  
[TK16J60W,S1VQ\(O](#) [2SK2614\(TE16L1,Q\)](#) [DMN1017UCP3-7](#) [DMN1053UCP4-7](#) [SQJ469EP-T1-GE3](#) [NTE2384](#) [DMC2700UDMQ-7](#)  
[DMN2080UCB4-7](#) [DMN61D9UWQ-13](#) [US6M2GTR](#) [DMN31D5UDJ-7](#) [DMP22D4UFO-7B](#) [DMN1006UCA6-7](#) [DMN16M9UCA6-7](#)  
[STF5N65M6](#) [IRF40H233XTMA1](#) [STU5N65M6](#) [DMN6022SSD-13](#) [DMN13M9UCA6-7](#) [DMTH10H4M6SPS-13](#) [DMN2990UFB-7B](#)  
[IPB80P04P405ATMA2](#) [2N7002W-G](#) [MCAC30N06Y-TP](#) [MCQ7328-TP](#) [BXP7N65D](#) [BXP4N65F](#) [AOL1454G](#) [WMJ80N60C4](#) [BXP2N20L](#)  
[BXP2N65D](#) [BXT1150N10J](#) [BXT1700P06M](#) [TSM60NB380CP ROG](#) [RQ7L055BGTCR](#) [DMNH15H110SK3-13](#) [SLF10N65ABV2](#)  
[BSO203SP](#) [BSO211P](#) [IPA60R230P6](#) [IPA60R460CE](#)