

N-Ch 200V Fast Switching MOSFETs
Description

The HSL03N20 is the high cell density trenched N-ch MOSFETs, which provides excellent RDSON and efficiency for most of the small power switching and load switch applications.

The HSL03N20 meets the RoHS and Green Product requirement with full function reliability approved.

- Green Device Available
- Super Low Gate Charge
- Excellent Cdv/dt effect decline
- Advanced high cell density Trench technology

Product Summary

V_{DS}	200	V
$R_{DS(ON),typ}$	0.6	Ω
I_D	1.5	A

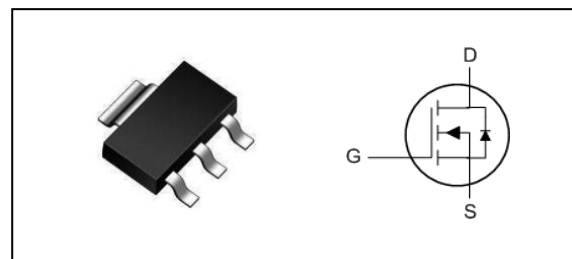
SOT223 Pin Configuration

Absolute Maximum Ratings

Symbol	Parameter	Rating	Units
V_{DS}	Drain-Source Voltage	200	V
V_{GS}	Gate-Source Voltage	± 20	V
$I_D@T_A=25^\circ C$	Continuous Drain Current, $V_{GS} @ 10V_1$	1.5	A
$I_D@T_A=70^\circ C$	Continuous Drain Current, $V_{GS} @ 10V_1$	1.3	A
I_{DM}	Pulsed Drain Current ₂	8	A
$P_D@T_A=25^\circ C$	Total Power Dissipation ₃	42	W
T_{STG}	Storage Temperature Range	-55 to 150	$^\circ C$
T_J	Operating Junction Temperature Range	-55 to 150	$^\circ C$

Thermal Data

Symbol	Parameter	Typ.	Max.	Unit
$R_{\theta JA}$	Thermal Resistance Junction-ambient ₁	---	85	$^\circ C/W$
$R_{\theta JC}$	Thermal Resistance Junction-Case ₁	---	30	$^\circ C/W$

N-Ch 200V Fast Switching MOSFETs
Electrical Characteristics ($T_J=25\text{ }^\circ\text{C}$, unless otherwise noted)

Symbol	Parameter	Conditions	Min.	Typ.	Max.	Unit
$B_{V_{DS}}$	Drain-Source Breakdown Voltage	$V_{GS}=0V, I_D=250\mu A$	200	---	---	V
$R_{DS(ON)}$	Static Drain-Source On-Resistance ²	$V_{GS}=10V, I_D=1A$	---	0.6	1.0	Ω
		$V_{GS}=4.5V, I_D=1A$	---	0.7	1.1	Ω
$V_{GS(th)}$	Gate Threshold Voltage	$V_{GS}=V_{DS}, I_D=250\mu A$	1.2	2	3	V
I_{DSS}	Drain-Source Leakage Current	$V_{DS}=200V, V_{GS}=0V, T_J=25^\circ C$	---	---	1	μA
		$V_{DS}=200V, V_{GS}=0V, T_J=55^\circ C$	---	---	5	μA
I_{GSS}	Gate-Source Leakage Current	$V_{GS}=\pm 20V, V_{DS}=0V$	---	---	± 100	nA
g_{fs}	Forward Transconductance	$V_{DS}=10V, I_D=1A$	---	10	---	S
Q_g	Total Gate Charge (10V)	$V_{DS}=160V, V_{GS}=10V, I_D=1A$	---	15	---	nC
Q_{gs}	Gate-Source Charge		---	2.9	---	
Q_{gd}	Gate-Drain Charge		---	5	---	
$T_{d(on)}$	Turn-On Delay Time	$V_{DD}=100V, V_{GS}=10V, R_G=3\Omega$ $I_D=1A$	---	22	---	ns
T_r	Rise Time		---	30	---	
$T_{d(off)}$	Turn-Off Delay Time		---	44	---	
T_f	Fall Time		---	12	---	
C_{iss}	Input Capacitance	$V_{DS}=25V, V_{GS}=0V, f=1MHz$	---	900	---	pF
C_{oss}	Output Capacitance		---	125	---	
C_{rss}	Reverse Transfer Capacitance		---	4.5	---	

Diode Characteristics

Symbol	Parameter	Conditions	Min.	Typ.	Max.	Unit
I_S	Continuous Source Current ^{1,4}	$V_G=V_D=0V$, Force Current	---	---	1	A
V_{SD}	Diode Forward Voltage ²	$V_{GS}=0V, I_S=1A, T_J=25^\circ C$	---	---	1	V
t_{rr}	Reverse Recovery Time	$I_F=1A, di/dt=100A/\mu s, T_J=25^\circ C$	---	85	---	nS
Q_{rr}	Reverse Recovery Charge		---	250	---	nC

Note:

1. The data tested by surface mounted on a 1 inch² FR-4 board with 2OZ copper.
2. The data tested by pulsed, pulse width $\leq 300\mu s$, duty cycle $\leq 2\%$
3. The power dissipation is limited by 150 $^\circ C$ junction temperature
4. The data is theoretically the same as I_D and I_{DM} , in real applications, should be limited by total power dissipation.

N-Ch 200V Fast Switching MOSFETs

Typical Characteristics

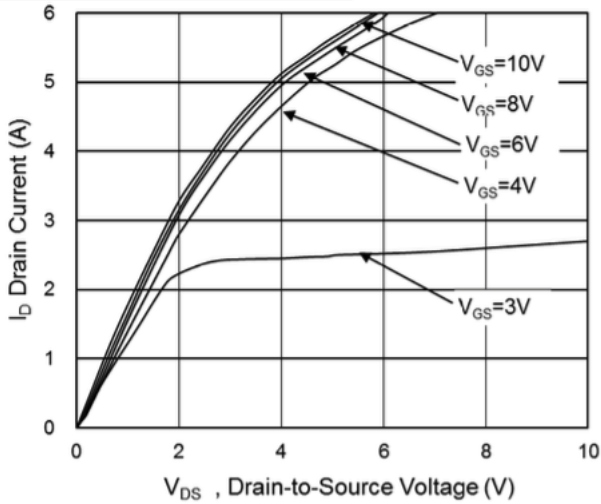

Fig.1 Typical Output Characteristics

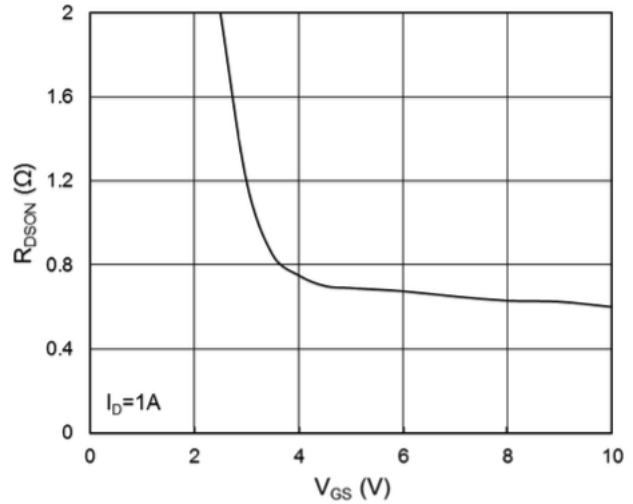

Fig.2 On-Resistance vs G-S Voltage

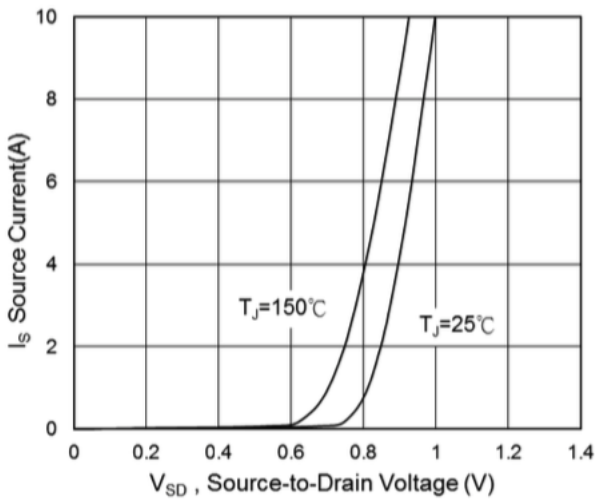

Fig.3 Forward Characteristics of Reverse

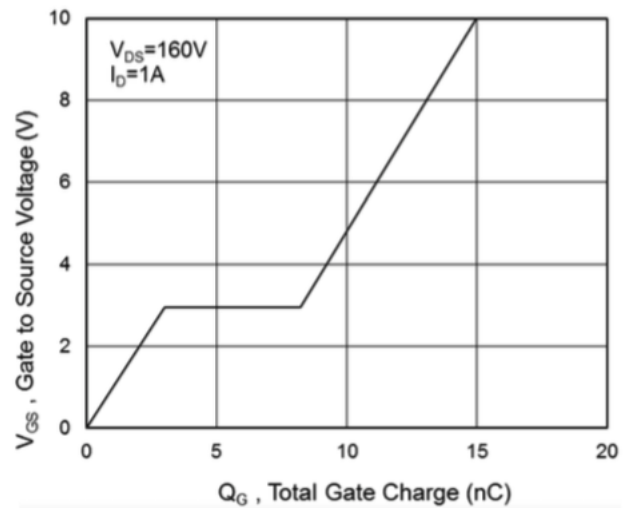

Fig.4 Gate-Charge Characteristics

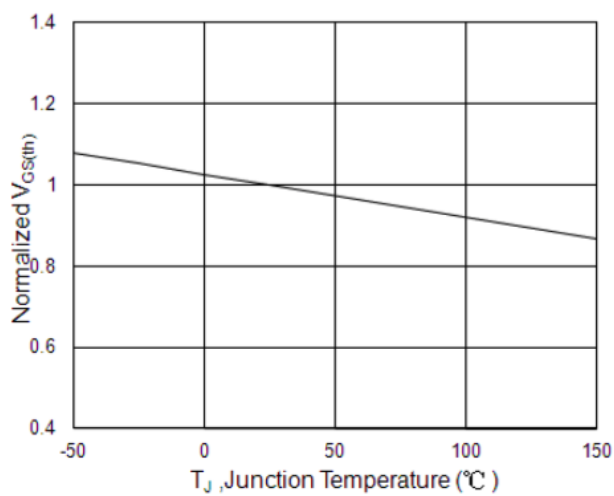

Fig.5 $V_{GS(th)}$ vs T_J

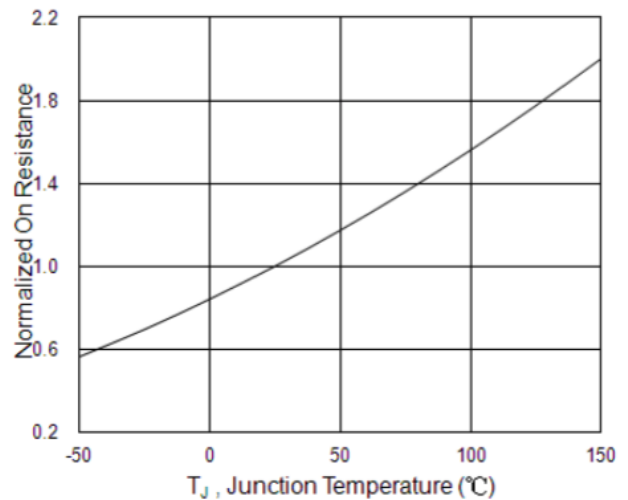

Fig.6 Normalized $R_{DS(on)}$ vs T_J



N-Ch 200V Fast Switching MOSFETs

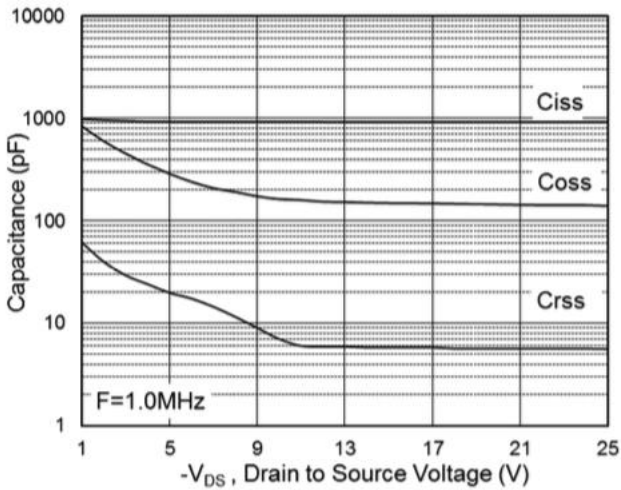

Fig.7 Capacitance

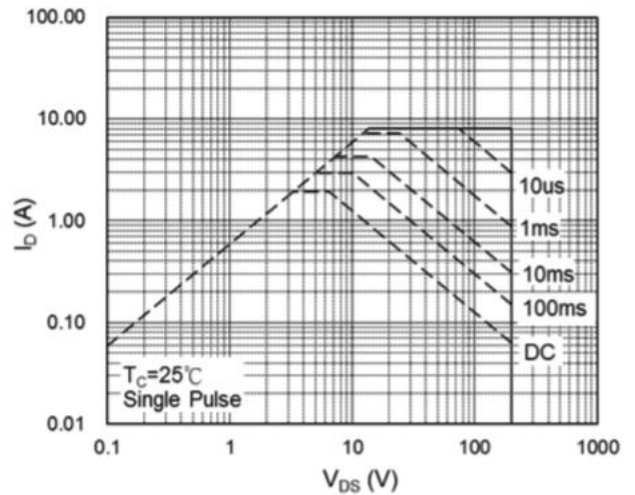

Fig.8 Safe Operating Area

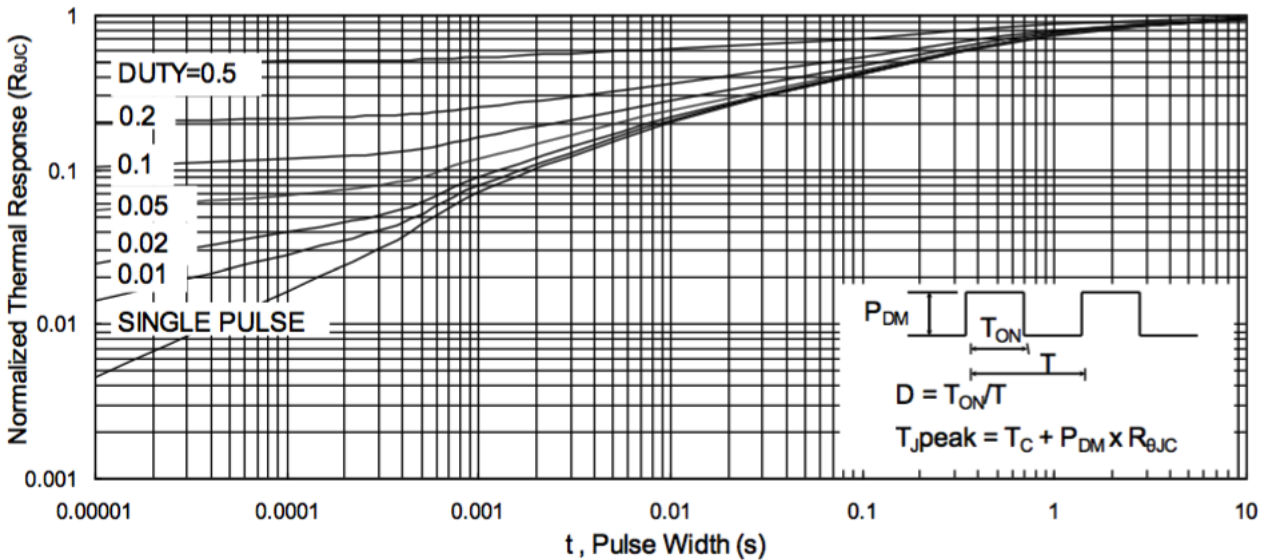

Fig.9 Normalized Maximum Transient Thermal Impedance

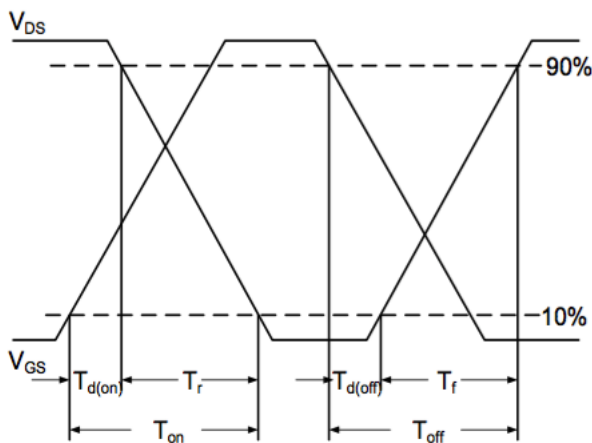

Fig.10 Switching Time Waveform

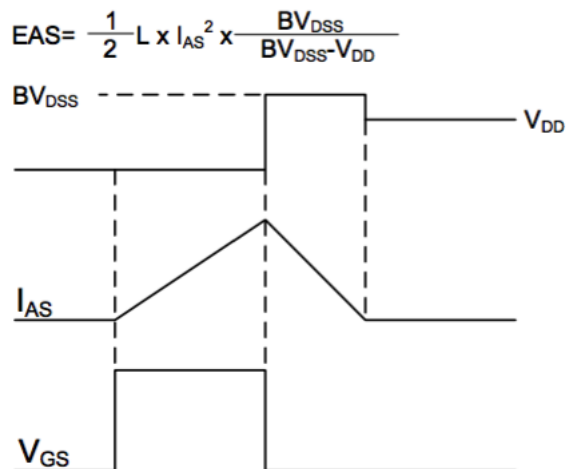

Fig.11 Gate Charge Waveform

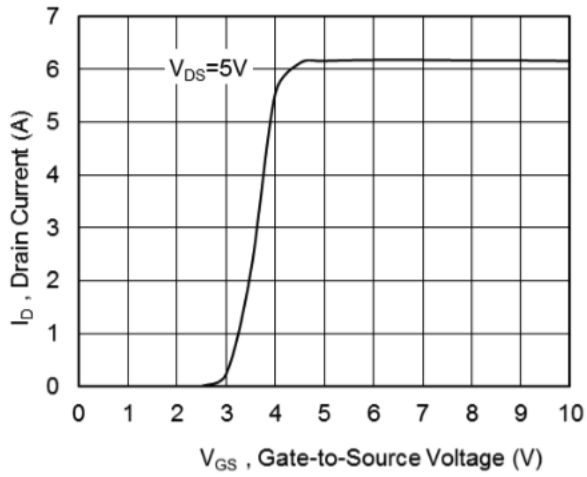
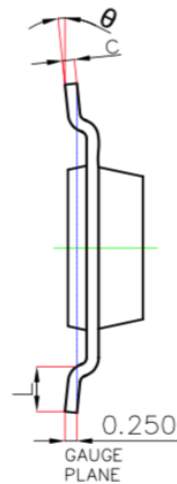
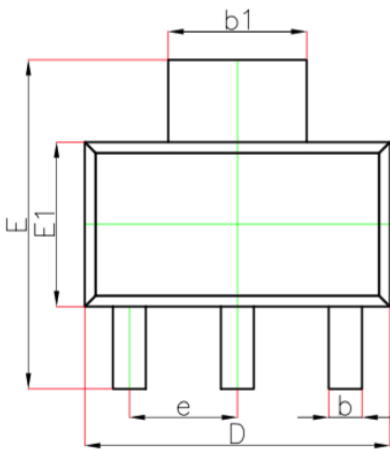

Fig.12 Transfer Characteristics

Ordering Information

Part Number	Package code	Packaging
HSL03N20	SOT-223	3000/Tape&Reel



Symbol	Dimensions In Millimeters		Dimensions In Inches	
	Min.	Max.	Min.	Max.
A	—	1.800	—	0.071
A1	0.020	0.100	0.001	0.004
A2	1.500	1.700	0.059	0.067
b	0.660	0.840	0.026	0.033
b_1	2.900	3.100	0.114	0.122
c	0.230	0.350	0.009	0.014
D	6.300	6.700	0.248	0.264
E	6.700	7.300	0.264	0.287
E1	3.300	3.700	0.130	0.146
e	2.300(BSC)		0.091(BSC)	
L	0.750	—	0.030	—
θ	0°	10°	0°	10°

X-ON Electronics

Largest Supplier of Electrical and Electronic Components

Click to view similar products for [MOSFET](#) category:

Click to view products by [HUASHUO](#) manufacturer:

Other Similar products are found below :

[614233C](#) [648584F](#) [MCH3443-TL-E](#) [MCH6422-TL-E](#) [FDPF9N50NZ](#) [FW216A-TL-2W](#) [FW231A-TL-E](#) [APT5010JVR](#) [NTNS3A92PZT5G](#)
[IRF100S201](#) [JANTX2N5237](#) [2SK2464-TL-E](#) [2SK3818-DL-E](#) [FCA20N60_F109](#) [FDZ595PZ](#) [STD6600NT4G](#) [FSS804-TL-E](#) [2SJ277-DL-E](#)
[2SK1691-DL-E](#) [2SK2545\(Q,T\)](#) [D2294UK](#) [405094E](#) [423220D](#) [MCH6646-TL-E](#) [TPCC8103,L1Q\(CM](#) [367-8430-0972-503](#) [VN1206L](#)
[424134F](#) [026935X](#) [051075F](#) [SBVS138LT1G](#) [614234A](#) [715780A](#) [NTNS3166NZT5G](#) [751625C](#) [873612G](#) [IRF7380TRHR](#)
[IPS70R2K0CEAKMA1](#) [RJK60S3DPP-E0#T2](#) [RJK60S5DPK-M0#T0](#) [APT5010JVFR](#) [APT12031JFLL](#) [APT12040JVR](#) [DMN3404LQ-7](#)
[NTE6400](#) [JANTX2N6796U](#) [JANTX2N6784U](#) [JANTXV2N5416U4](#) [SQM110N05-06L-GE3](#) [SIHF35N60E-GE3](#)