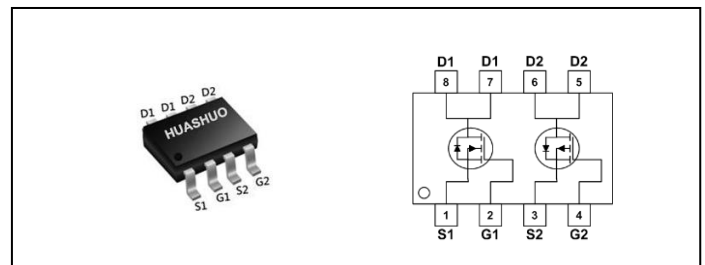

**N-Ch and P-Ch Fast Switching MOSFETs**
**Application**

- Power Management.
- DC Motor Control.
- Super Low Gate Charge
- 100% EAS Guaranteed
- Green Device Available
- Excellent CdV/dt effect decline
- Advanced high cell density Trench technology

**Product Summary**

BVDSS	RDSON	ID
100V	100mΩ	3A
-100V	220mΩ	-2.1A

**SOP8 Pin Configuration**

**Absolute Maximum Ratings**

Symbol	Parameter	Rating		Units
		N-Channel	P-Channel	
$V_{DS}$	Drain-Source Voltage	100	-100	V
$V_{GS}$	Gate-Source Voltage	±20	±20	V
$I_D@T_A=25^{\circ}C$	Continuous Drain Current, $V_{GS} @ 10V^1$	3	-2.1	A
$I_D@T_A=70^{\circ}C$	Continuous Drain Current, $V_{GS} @ 10V^1$	2.4	-1.7	A
$I_{DM}$	Pulsed Drain Current <sup>2</sup>	10	-10	A
EAS	Single Pulse Avalanche Energy <sup>3</sup>	25	49	mJ
$I_{AS}$	Avalanche Current	10	-14	A
$P_D@T_A=25^{\circ}C$	Total Power Dissipation <sup>4</sup>	2.1	2.1	W
$T_{STG}$	Storage Temperature Range	-55 to 150	-55 to 150	°C
$T_J$	Operating Junction Temperature Range	-55 to 150	-55 to 150	°C

**Thermal Data**

Symbol	Parameter	Typ.	Max.	Unit
$R_{\theta JA}$	Thermal Resistance Junction-Ambient <sup>1</sup>	---	100	°C/W
$R_{\theta JC}$	Thermal Resistance Junction-Case <sup>1</sup>	---	60	°C/W

**N-Channel Electrical Characteristics ( $T_J=25\text{ }^\circ\text{C}$ , unless otherwise noted)**

Symbol	Parameter	Conditions	Min.	Typ.	Max.	Unit
$BV_{DSS}$	Drain-Source Breakdown Voltage	$V_{GS}=0V, I_D=250\mu A$	100	---	---	V
$\Delta BV_{DSS}/\Delta T_J$	$BV_{DSS}$ Temperature Coefficient	Reference to $25^\circ\text{C}$ , $I_D=1\text{mA}$	---	0.063	---	$V/^\circ\text{C}$
$R_{DS(ON)}$	Static Drain-Source On-Resistance <sup>2</sup>	$V_{GS}=10V, I_D=2.5A$	---	80	100	m $\Omega$
		$V_{GS}=4.5V, I_D=2A$	---	90	125	
$V_{GS(th)}$	Gate Threshold Voltage	$V_{GS}=V_{DS}, I_D=250\mu A$	1.2	---	2.5	V
$\Delta V_{GS(th)}$	$V_{GS(th)}$ Temperature Coefficient		---	-5.24	---	$\text{mV}/^\circ\text{C}$
$I_{DSS}$	Drain-Source Leakage Current	$V_{DS}=80V, V_{GS}=0V, T_J=25^\circ\text{C}$	---	---	1	$\mu\text{A}$
		$V_{DS}=80V, V_{GS}=0V, T_J=55^\circ\text{C}$	---	---	30	
$I_{GSS}$	Gate-Source Leakage Current	$V_{GS}=\pm 20V, V_{DS}=0V$	---	---	$\pm 100$	nA
$R_g$	Gate Resistance	$V_{DS}=0V, V_{GS}=0V, f=1\text{MHz}$	---	3.5	---	$\Omega$
$Q_g$	Total Gate Charge (4.5V)	$V_{DS}=50V, V_{GS}=4.5V, I_D=2A$	---	15	---	nC
$Q_{gs}$	Gate-Source Charge		---	3.2	---	
$Q_{gd}$	Gate-Drain Charge		---	2.3	---	
$T_{d(on)}$	Turn-On Delay Time	$V_{DD}=30V, V_{GS}=10V, R_G=3.3\Omega, I_D=1A$	---	8	---	ns
$T_r$	Rise Time		---	12	---	
$T_{d(off)}$	Turn-Off Delay Time		---	20	---	
$T_f$	Fall Time		---	6	---	
$C_{iss}$	Input Capacitance	$V_{DS}=30V, V_{GS}=0V, f=1\text{MHz}$	---	990	---	pF
$C_{oss}$	Output Capacitance		---	36	---	
$C_{rss}$	Reverse Transfer Capacitance		---	24	---	

**Diode Characteristics**

Symbol	Parameter	Conditions	Min.	Typ.	Max.	Unit
$I_S$	Continuous Source Current <sup>1,5</sup>	$V_G=V_D=0V$ , Force Current	---	---	2	A
$V_{SD}$	Diode Forward Voltage <sup>2</sup>	$V_{GS}=0V, I_S=1A, T_J=25^\circ\text{C}$	---	---	1.2	V

Note :

- 1.The data tested by surface mounted on a 1 inch<sup>2</sup> FR-4 board with 2OZ copper.
- 2.The data tested by pulsed , pulse width  $\leq 300\mu\text{s}$  , duty cycle  $\leq 2\%$
- 3.The EAS data shows Max. rating . The test condition is  $V_{DD}=25V, V_{GS}=10V, L=0.5\text{mH}, I_{AS}=10A$
- 4.The power dissipation is limited by  $150^\circ\text{C}$  junction temperature
- 5.The data is theoretically the same as  $I_D$  and  $I_{DM}$  , in real applications , should be limited by total power dissipation.

**P-Channel Electrical Characteristics (T<sub>J</sub>=25 °C, unless otherwise noted)**

Symbol	Parameter	Conditions	Min.	Typ.	Max.	Unit
BV <sub>DSS</sub>	Drain-Source Breakdown Voltage	V <sub>GS</sub> =0V, I <sub>D</sub> =-250uA	-100	---	---	V
ΔBV <sub>DSS</sub> /ΔT <sub>J</sub>	BV <sub>DSS</sub> Temperature Coefficient	Reference to 25°C, I <sub>D</sub> =-1mA	---	-0.03	---	V/°C
R <sub>DS(ON)</sub>	Static Drain-Source On-Resistance <sup>2</sup>	V <sub>GS</sub> =-10V, I <sub>D</sub> =-2A	---	180	220	mΩ
		V <sub>GS</sub> =-4.5V, I <sub>D</sub> =-1.6A	---	200	255	
V <sub>GS(th)</sub>	Gate Threshold Voltage	V <sub>GS</sub> =V <sub>DS</sub> , I <sub>D</sub> =-250uA	-1.2	---	-2.5	V
ΔV <sub>GS(th)</sub>	V <sub>GS(th)</sub> Temperature Coefficient		---	4.56	---	mV/°C
I <sub>DSS</sub>	Drain-Source Leakage Current	V <sub>DS</sub> =-80V, V <sub>GS</sub> =0V, T <sub>J</sub> =25°C	---	---	1	uA
		V <sub>DS</sub> =-80V, V <sub>GS</sub> =0V, T <sub>J</sub> =55°C	---	---	30	
I <sub>GSS</sub>	Gate-Source Leakage Current	V <sub>GS</sub> =±20V, V <sub>DS</sub> =0V	---	---	±100	nA
R <sub>g</sub>	Gate Resistance	V <sub>DS</sub> =0V, V <sub>GS</sub> =0V, f=1MHz	---	13	---	Ω
Q <sub>g</sub>	Total Gate Charge (-10V)	V <sub>DS</sub> =-50V, V <sub>GS</sub> =-10V, I <sub>D</sub> =-2A	---	19	---	nC
Q <sub>gs</sub>	Gate-Source Charge		---	3.1	---	
Q <sub>gd</sub>	Gate-Drain Charge		---	2.95	---	
T <sub>d(on)</sub>	Turn-On Delay Time	V <sub>DD</sub> =-30V, V <sub>GS</sub> =-10V, R <sub>G</sub> =3.3Ω, I <sub>D</sub> =-1A	---	9	---	ns
T <sub>r</sub>	Rise Time		---	6	---	
T <sub>d(off)</sub>	Turn-Off Delay Time		---	38	---	
T <sub>f</sub>	Fall Time		---	33	---	
C <sub>iss</sub>	Input Capacitance	V <sub>DS</sub> =-30V, V <sub>GS</sub> =0V, f=1MHz	---	1229	---	pF
C <sub>oss</sub>	Output Capacitance		---	41	---	
C <sub>rss</sub>	Reverse Transfer Capacitance		---	29	---	

**Diode Characteristics**

Symbol	Parameter	Conditions	Min.	Typ.	Max.	Unit
I <sub>S</sub>	Continuous Source Current <sup>1,5</sup>	V <sub>G</sub> =V <sub>D</sub> =0V, Force Current	---	---	-1.5	A
V <sub>SD</sub>	Diode Forward Voltage <sup>2</sup>	V <sub>GS</sub> =0V, I <sub>S</sub> =-1A, T <sub>J</sub> =25°C	---	---	-1.2	V

Note :

- 1.The data tested by surface mounted on a 1 inch<sup>2</sup> FR-4 board with 20Z copper.
- 2.The data tested by pulsed , pulse width ≤ 300us , duty cycle ≤ 2%
- 3.The EAS data shows Max. rating . The test condition is V<sub>DD</sub>=-25V, V<sub>GS</sub>=-10V, L=0.5mH, I<sub>AS</sub>=-14A
- 4.The power dissipation is limited by 150°C junction temperature
- 5.The data is theoretically the same as I<sub>D</sub> and I<sub>DM</sub> , in real applications , should be limited by total power dissipation.

**N-Channel Typical Characteristics**

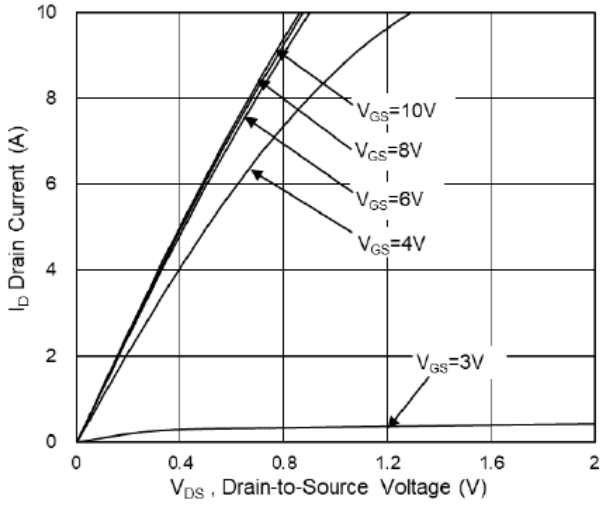

**Fig.1 Typical Output Characteristics**

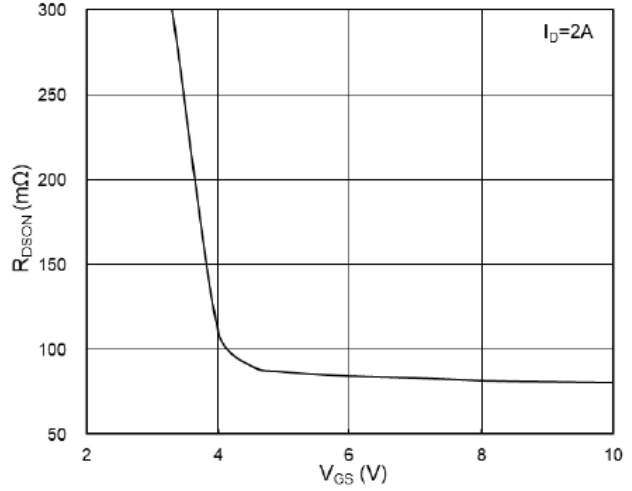

**Fig.2 On-Resistance v.s Gate-Source**

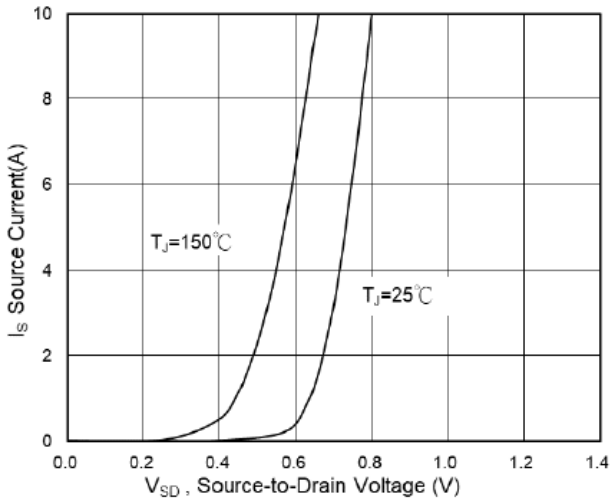

**Fig.3 Forward Characteristics of Reverse**

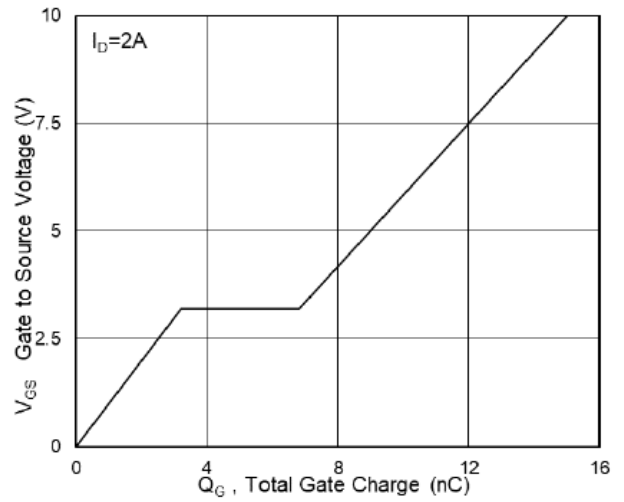

**Fig.4 Gate-Charge Characteristics**

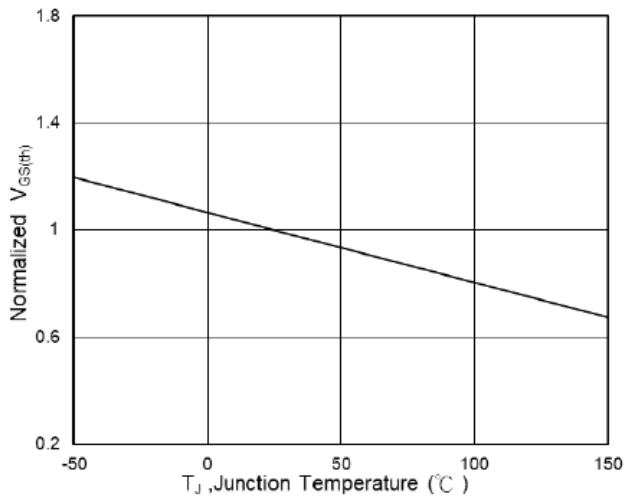

**Fig.5 Normalized  $V_{GS(th)}$  v.s  $T_J$**

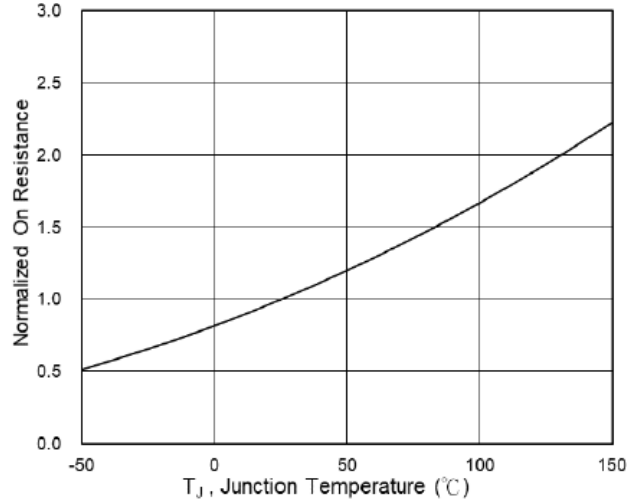

**Fig.6 Normalized  $R_{DS(on)}$  v.s  $T_J$**



**N-Ch and P-Ch Fast Switching MOSFETs**

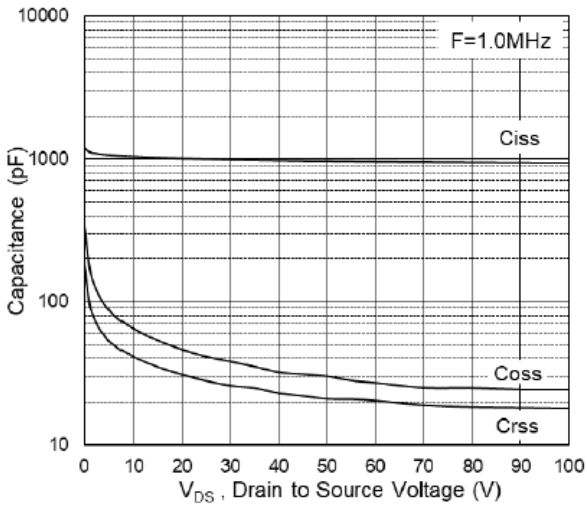

**Fig.7 Capacitance**

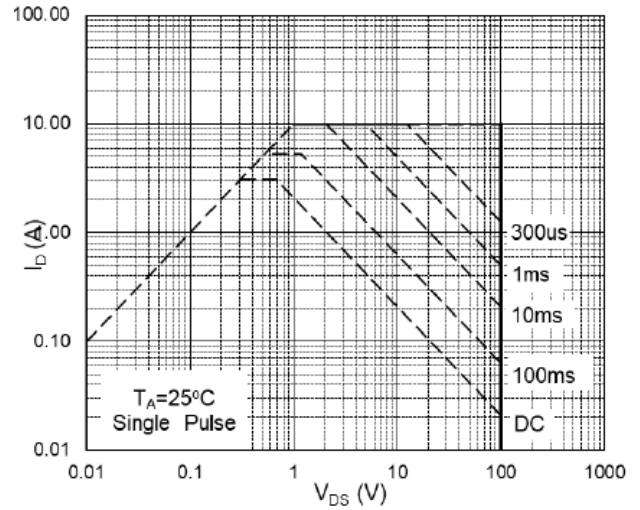

**Fig.8 Safe Operating Area**

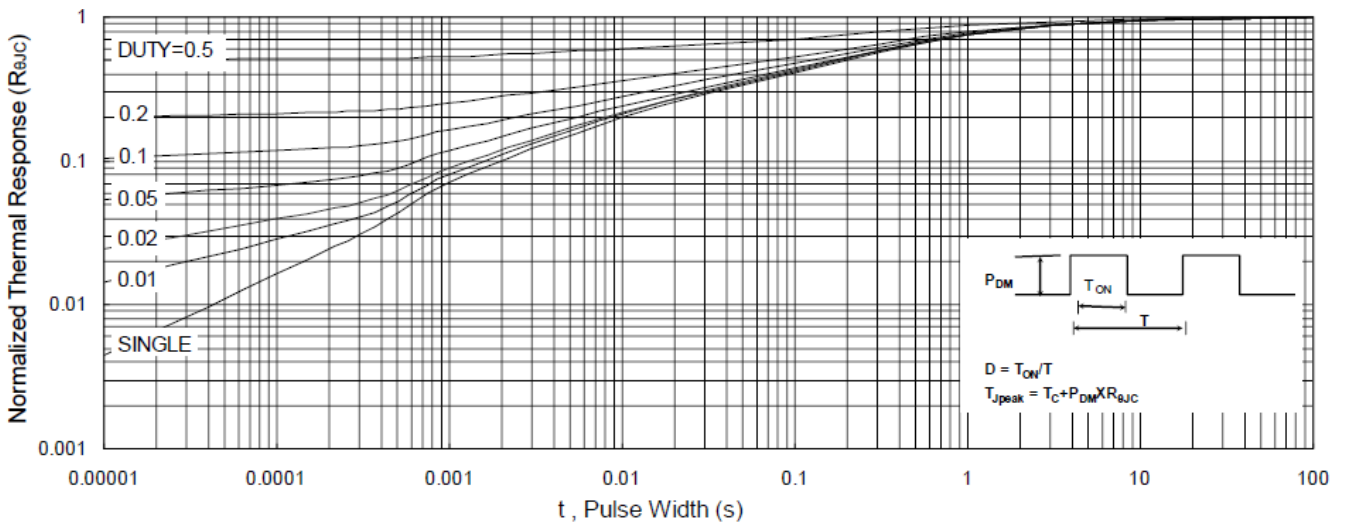

**Fig.9 Normalized Maximum Transient Thermal Impedance**

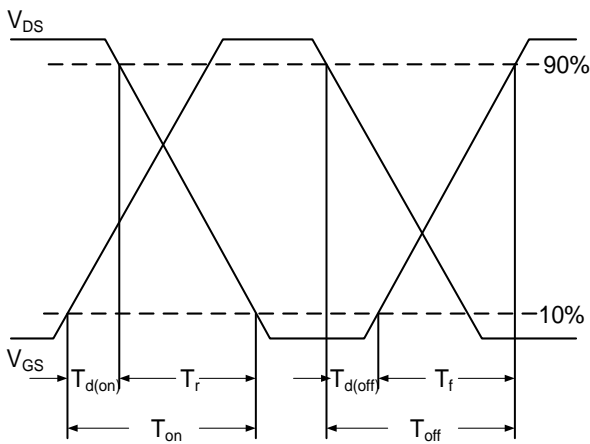

**Fig.10 Switching Time Waveform**

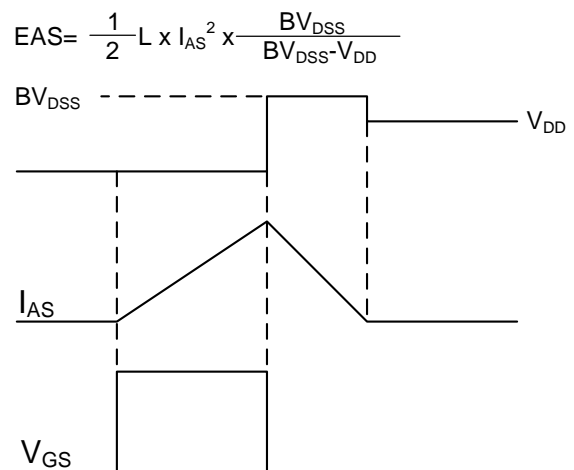

**Fig.11 Unclamped Inductive Waveform**



N-Ch and P-Ch Fast Switching MOSFETs

P-Channel Typical Characteristics

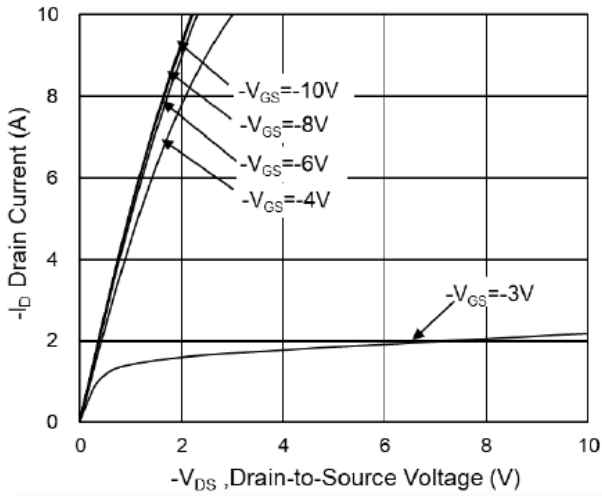

Fig.1 Typical Output Characteristics

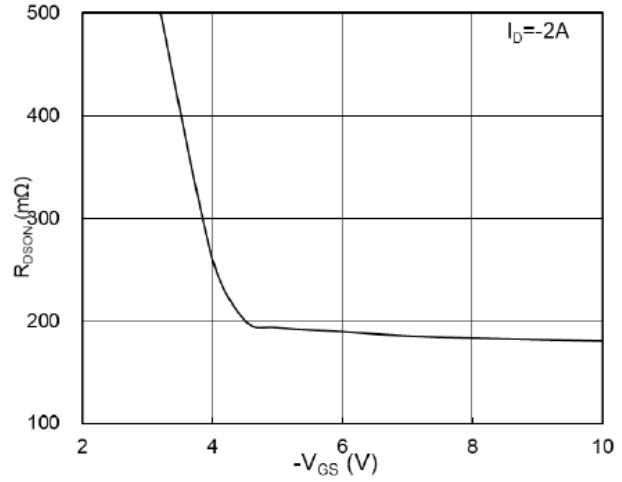

Fig.2 On-Resistance v.s Gate-Source

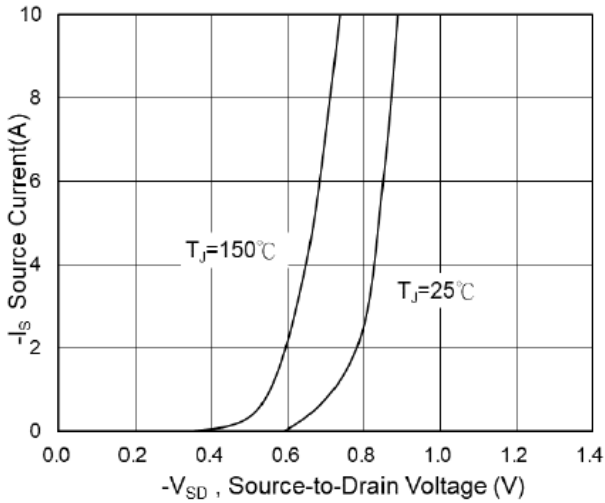

Fig.3 Forward Characteristics of Reverse

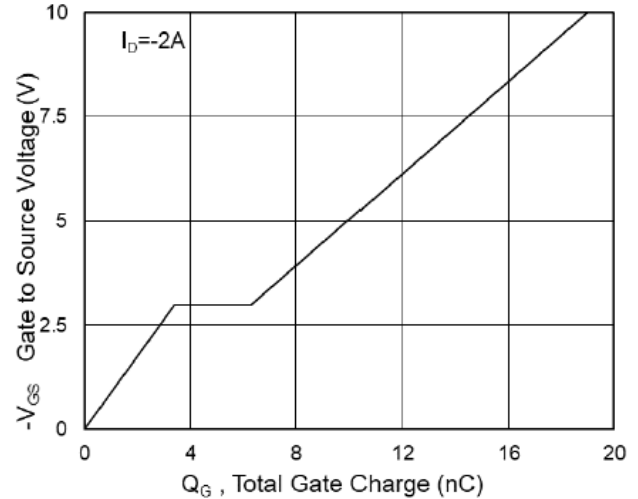

Fig.4 Gate-Charge Characteristics

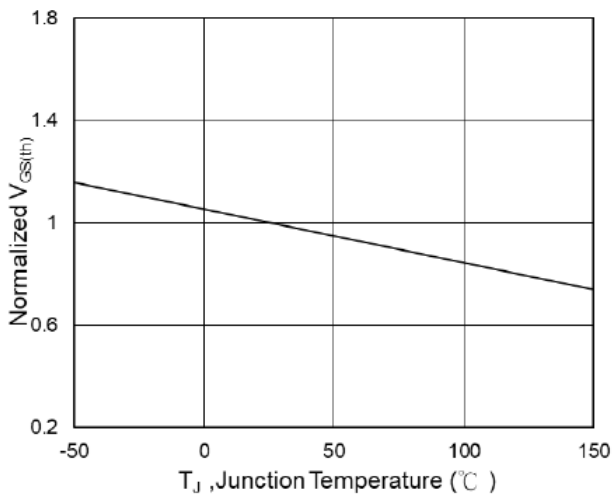

Fig.5 Normalized  $V_{GS(th)}$  v.s  $T_J$

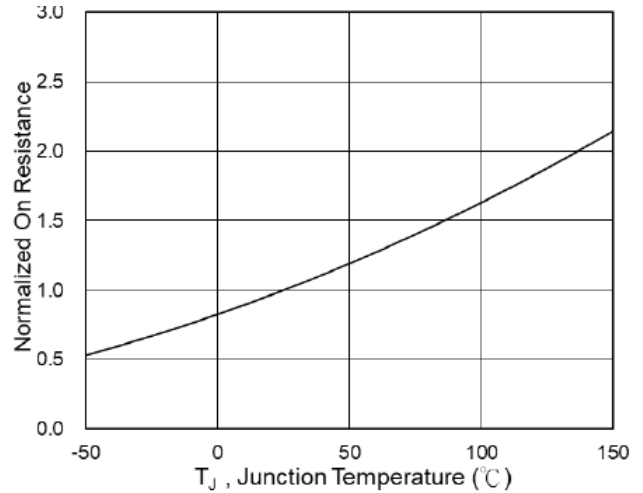
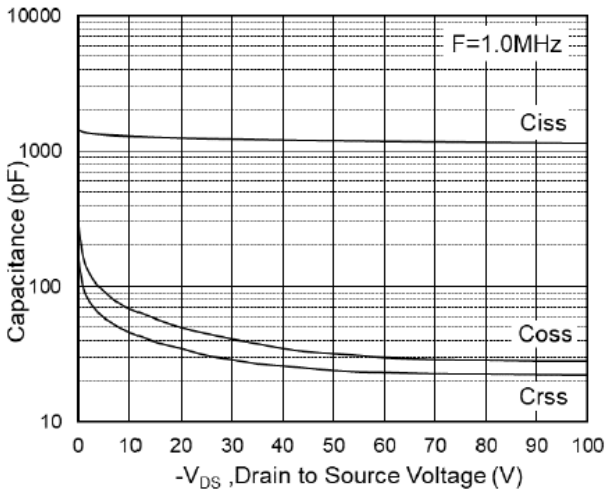

Fig.6 Normalized  $R_{DS(on)}$  v.s  $T_J$



**N-Ch and P-Ch Fast Switching MOSFETs**



**Fig.7 Capacitance**

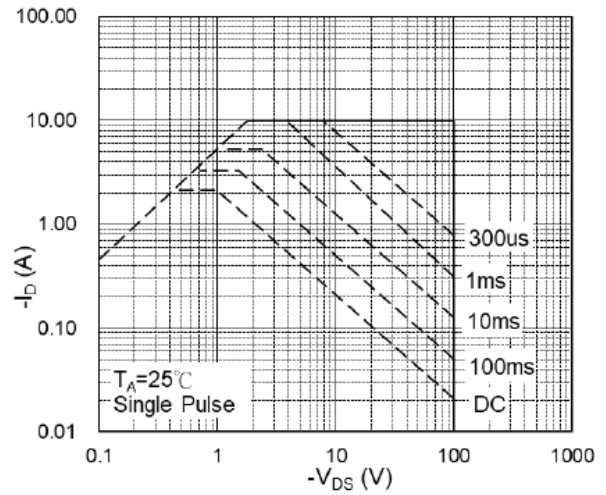

**Fig.8 Safe Operating Area**

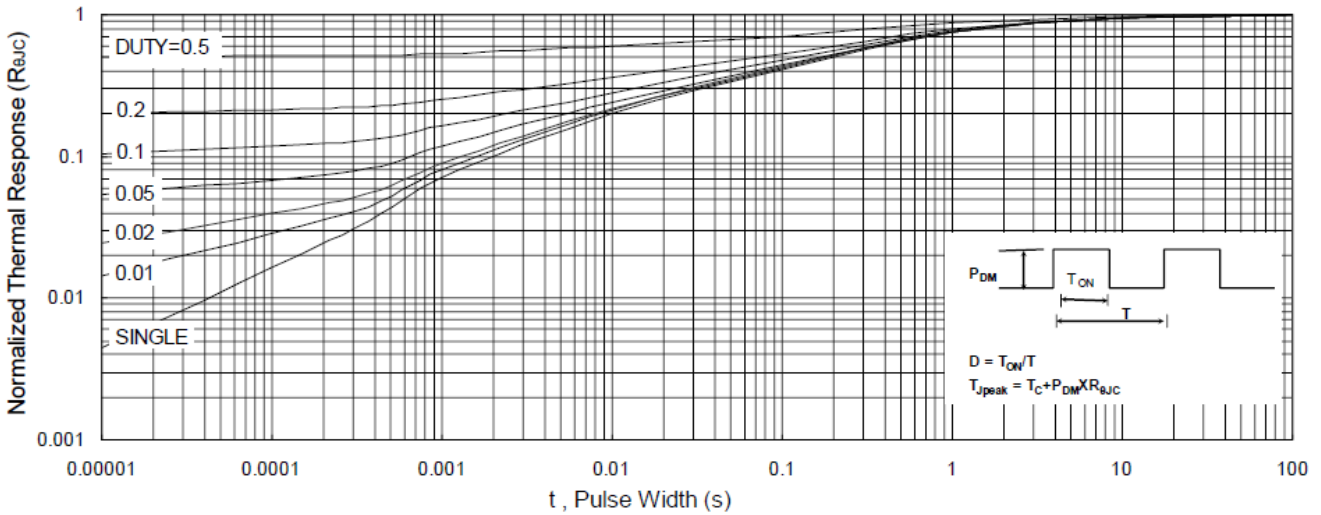

**Fig.9 Normalized Maximum Transient Thermal Impedance**

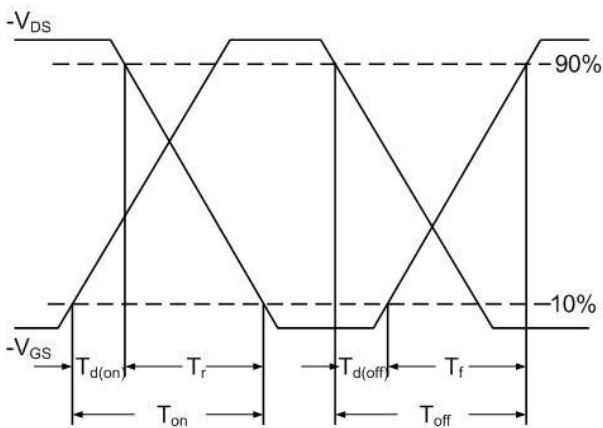

**Fig.10 Switching Time Waveform**

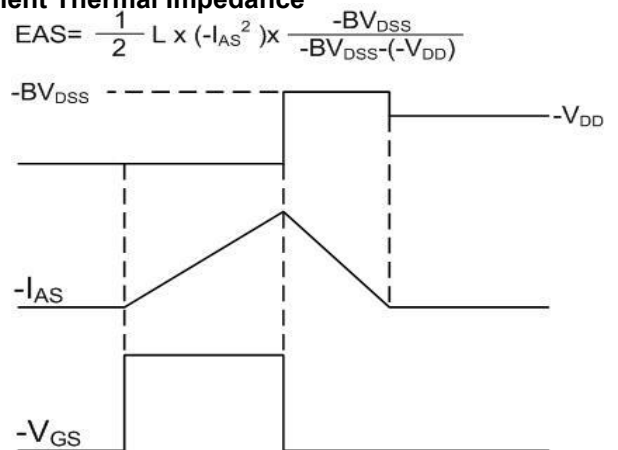

**Fig.11 Unclamped Inductive Waveform**

## Ordering Information

Part Number	Package code	Packaging
HSM0903	SOP-8	2500/Tape&Reel

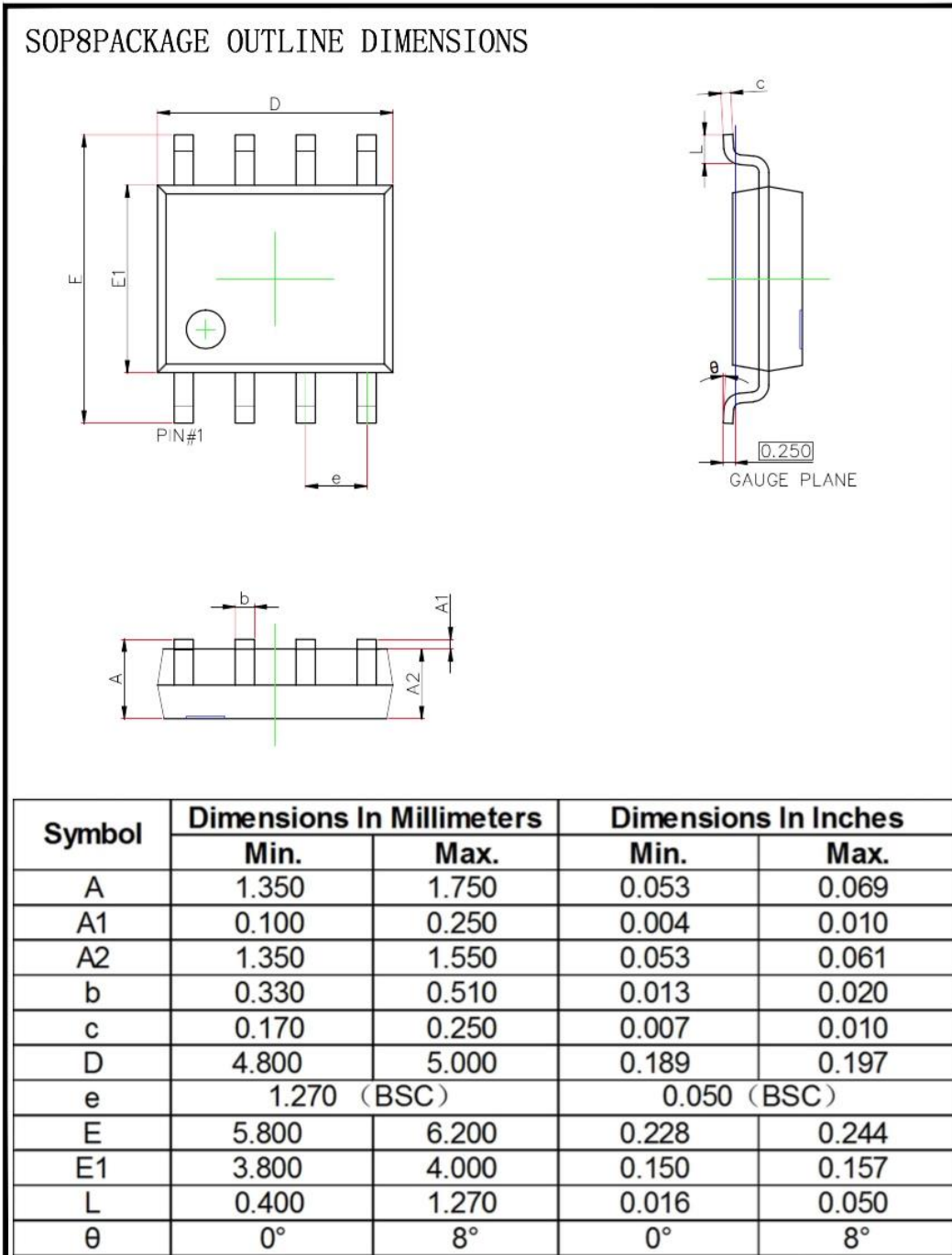



## X-ON Electronics

Largest Supplier of Electrical and Electronic Components

*Click to view similar products for [MOSFET](#) category:*

*Click to view products by [HUASHUO](#) manufacturer:*

Other Similar products are found below :

[614233C](#) [648584F](#) [IRFD120](#) [IRFF430](#) [JANTX2N5237](#) [2N7000](#) [FCA20N60\\_F109](#) [FDZ595PZ](#) [AOD464](#) [2SK2267\(Q\)](#) [2SK2545\(Q,T\)](#)  
[405094E](#) [423220D](#) [MIC4420CM-TR](#) [VN1206L](#) [614234A](#) [715780A](#) [SSM6J414TU,LF\(T](#) [751625C](#) [PSMN4R2-30MLD](#)  
[TK31J60W5,S1VQ\(O](#) [2SK2614\(TE16L1,Q\)](#) [DMN1017UCP3-7](#) [EFC2J004NUZTDG](#) [FCAB21350L1](#) [P85W28HP2F-7071](#) [DMN1053UCP4-7](#)  
[NTE2384](#) [NTE2969](#) [NTE6400A](#) [DMN2080UCB4-7](#) [DMN61D9UWQ-13](#) [US6M2GTR](#) [DMN31D5UDJ-7](#) [SSM6P54TU,LF](#) [DMP22D4UFO-](#)  
[7B](#) [IPS60R3K4CEAKMA1](#) [DMN1006UCA6-7](#) [DMN16M9UCA6-7](#) [STF5N65M6](#) [STU5N65M6](#) [C3M0021120D](#) [DMN13M9UCA6-7](#)  
[BSS340NWH6327XTSA1](#) [MCM3400A-TP](#) [DMTH10H4M6SPS-13](#) [IRF40SC240ARMA1](#) [IPS60R1K0PFD7SAKMA1](#)  
[IPS60R360PFD7SAKMA1](#) [IPS60R600PFD7SAKMA1](#)