

Description

The HSP3018B is the high cell density trenched N-ch MOSFETs, which provide excellent RDSON and gate charge for most of the synchronous buck converter applications.

The HSP3018B meet the RoHS and Green Product requirement, 100% EAS guaranteed with full function reliability approved.

- 100% EAS Guaranteed
- Green Device Available
- Super Low Gate Charge
- Excellent CdV/dt effect decline
- Advanced high cell density Trench technology

Product Summary

V_{DS}	30	V
$R_{DS(ON),typ}$	2	m Ω
I_D	205	A

TO-220 Pin Configuration

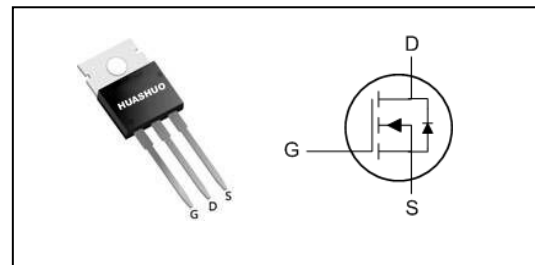

Absolute Maximum Ratings

Symbol	Parameter	Rating	Units
V_{DS}	Drain-Source Voltage	30	V
V_{GS}	Gate-Source Voltage	± 20	V
$I_D@T_C=25^\circ C$	Continuous Drain Current, $V_{GS} @ 10V_{1.6}$	205	A
$I_D@T_C=100^\circ C$	Continuous Drain Current, $V_{GS} @ 10V_{1.6}$	145	A
I_{DM}	Pulsed Drain Current ²	500	A
EAS	Single Pulse Avalanche Energy ³	246	mJ
I_{AS}	Avalanche Current	70.2	A
$P_D@T_C=25^\circ C$	Total Power Dissipation ⁴	187	W
T_{STG}	Storage Temperature Range	-55 to 150	$^\circ C$
T_J	Operating Junction Temperature Range	-55 to 150	$^\circ C$

Thermal Data

Symbol	Parameter	Typ.	Max.	Unit
$R_{\theta JA}$	Thermal Resistance Junction-Ambient ¹	---	62	$^\circ C/W$
$R_{\theta JC}$	Thermal Resistance Junction-Case ¹	---	0.8	$^\circ C/W$



Electrical Characteristics (T_J=25 °C, unless otherwise noted)

Symbol	Parameter	Conditions	Min.	Typ.	Max.	Unit
B _{VDS}	Drain-Source Breakdown Voltage	V _{GS} =0V, I _D =250uA	30	---	---	V
ΔB _{VDS} /ΔT _J	B _{VDS} Temperature Coefficient	Reference to 25°C, I _D =1mA	---	0.014	---	V/°C
R _{DS(ON)}	Static Drain-Source On-Resistance ₂	V _{GS} =10V, I _D =30A	---	2	2.4	mΩ
		V _{GS} =4.5V, I _D =15A	---	2.6	3.2	
V _{GS(th)}	Gate Threshold Voltage	V _{GS} =V _{DS} , I _D =250uA	1.2	---	2.5	V
ΔV _{GS(th)}	V _{GS(th)} Temperature Coefficient		---	-4	---	mV/°C
I _{DSS}	Drain-Source Leakage Current	V _{DS} =24V, V _{GS} =0V, T _J =25°C	---	---	1	uA
		V _{DS} =24V, V _{GS} =0V, T _J =55°C	---	---	5	
I _{GSS}	Gate-Source Leakage Current	V _{GS} =±20V, V _{DS} =0V	---	---	±100	nA
g _{fs}	Forward Transconductance	V _{DS} =5V, I _D =30A	---	50	---	S
R _g	Gate Resistance	V _{DS} =0V, V _{GS} =0V, f=1MHz	---	1.7	---	Ω
Q _g	Total Gate Charge (4.5V)	V _{DS} =15V, V _{GS} =10V, I _D =15A	---	56.9	---	nC
Q _{gs}	Gate-Source Charge		---	13.8	---	
Q _{gd}	Gate-Drain Charge		---	23.5	---	
T _{d(on)}	Turn-On Delay Time	V _{DD} =15V, V _{GS} =10V, R _G =3.3Ω, I _D =1A	---	20.1	---	ns
T _r	Rise Time		---	6.3	---	
T _{d(off)}	Turn-Off Delay Time		---	124.6	---	
T _f	Fall Time		---	15.8	---	
C _{iss}	Input Capacitance	V _{DS} =15V, V _{GS} =0V, f=1MHz	---	5850	---	pF
C _{oss}	Output Capacitance		---	720	---	
C _{rss}	Reverse Transfer Capacitance		---	525	---	

Diode Characteristics

Symbol	Parameter	Conditions	Min.	Typ.	Max.	Unit
I _S	Continuous Source Current _{1,6}	V _G =V _D =0V, Force Current	---	---	205	A
V _{SD}	Diode Forward Voltage ₂	V _{GS} =0V, I _S =1A, T _J =25°C	---	---	1.2	V

Note :

- 1.The data tested by surface mounted on a 1 inch₂ FR-4 board with 2OZ copper.
- 2.The data tested by pulsed , pulse width ≤ 300us , duty cycle ≤ 2%
- 3.The EAS data shows Max. rating . The test condition is V_{DD}=25V, V_{GS}=10V, L=0.1mH, I_{AS}=70.2A
- 4.The power dissipation is limited by 150°C junction temperature
- 5.The data is theoretically the same as I_D and I_{DM} , in real applications , should be limited by total power dissipation.
- 6.Package limitation current is 85A.



Typical Characteristics

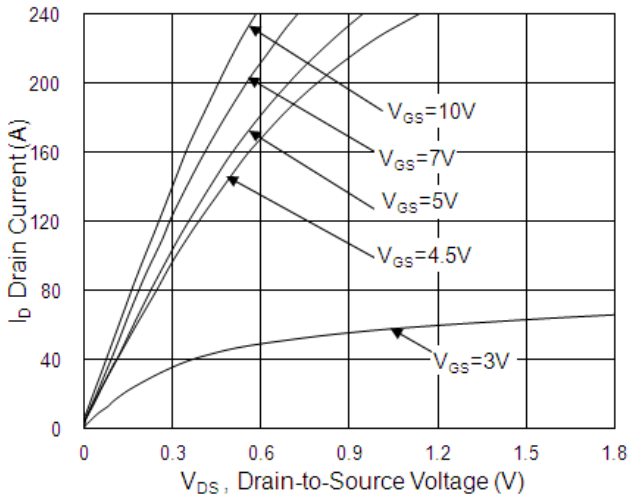

Fig.1 Typical Output Characteristics

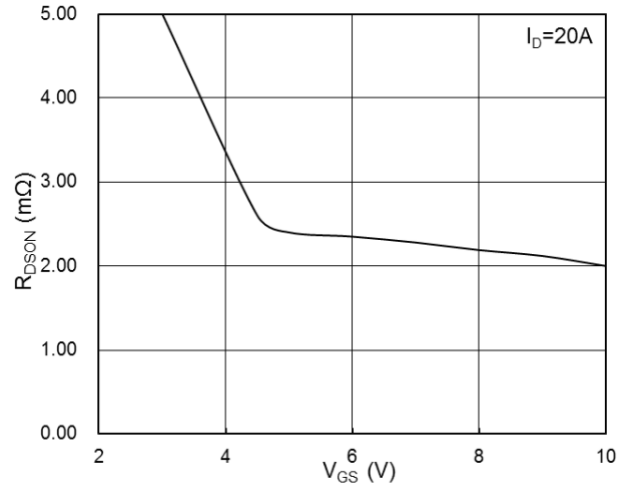

Fig.2 On-Resistance v.s Gate-Source

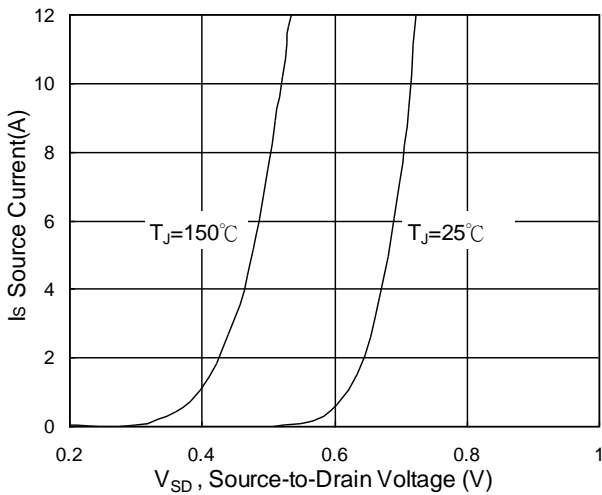

Fig.3 Forward Characteristics of Reverse

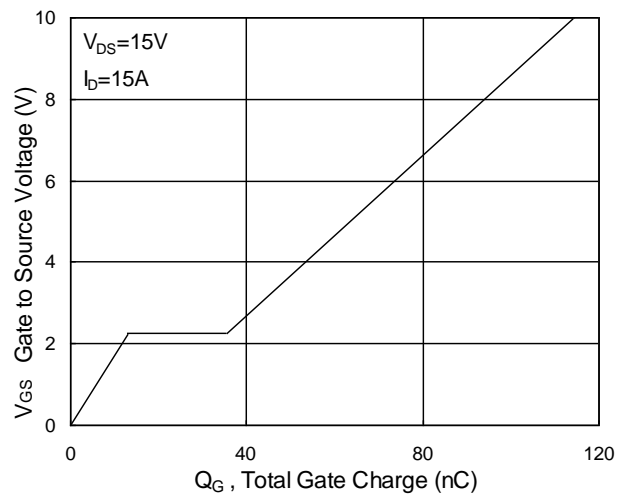

Fig.4 Gate-Charge Characteristics

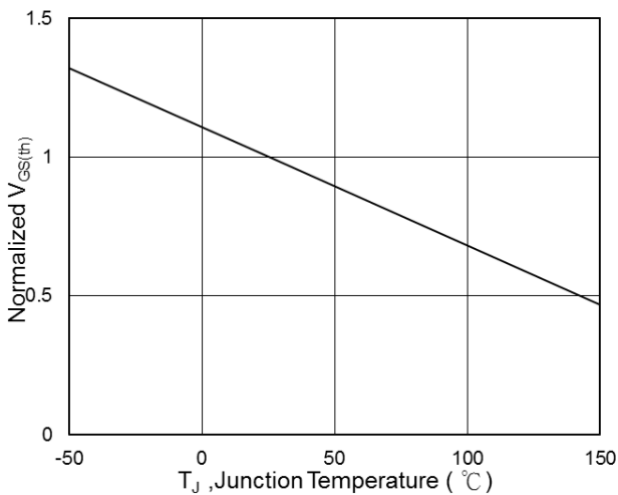

Fig.5 Normalized $V_{GS(th)}$ v.s T_J

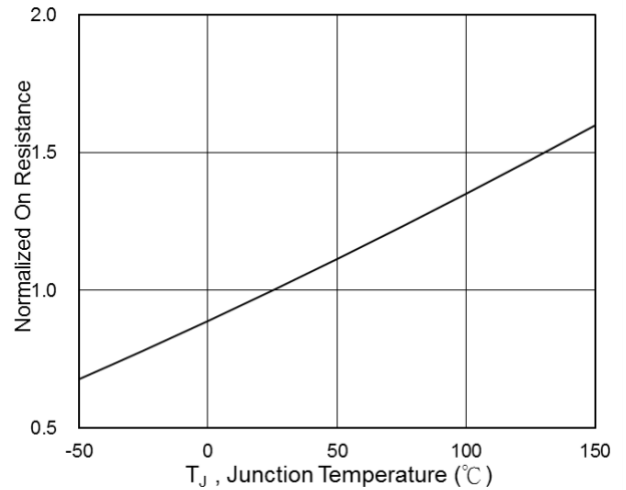

Fig.6 Normalized $R_{DS(on)}$ v.s T_J

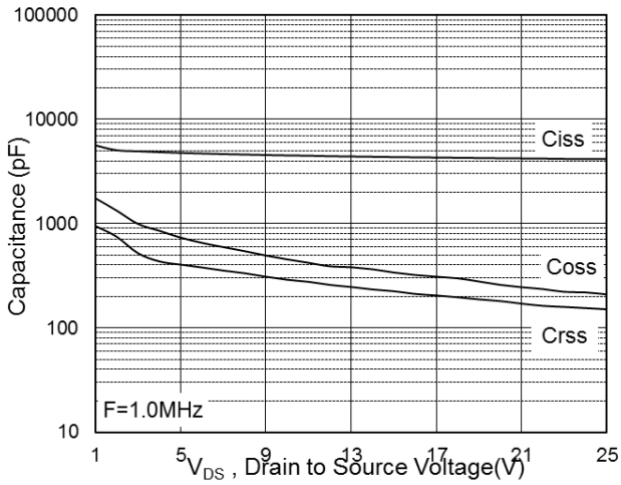

Fig.7 Capacitance

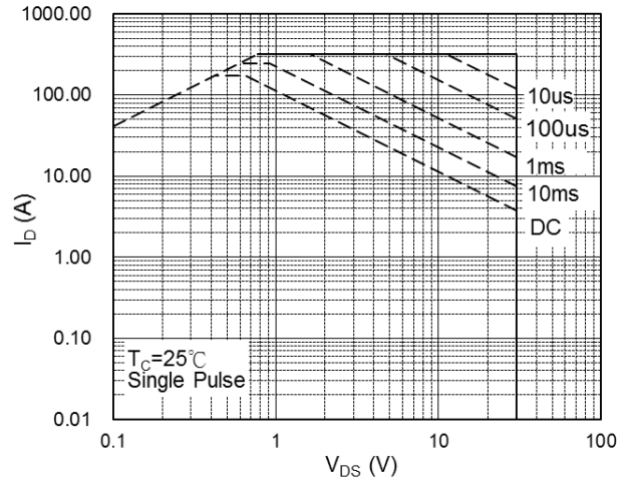

Fig.8 Safe Operating Area

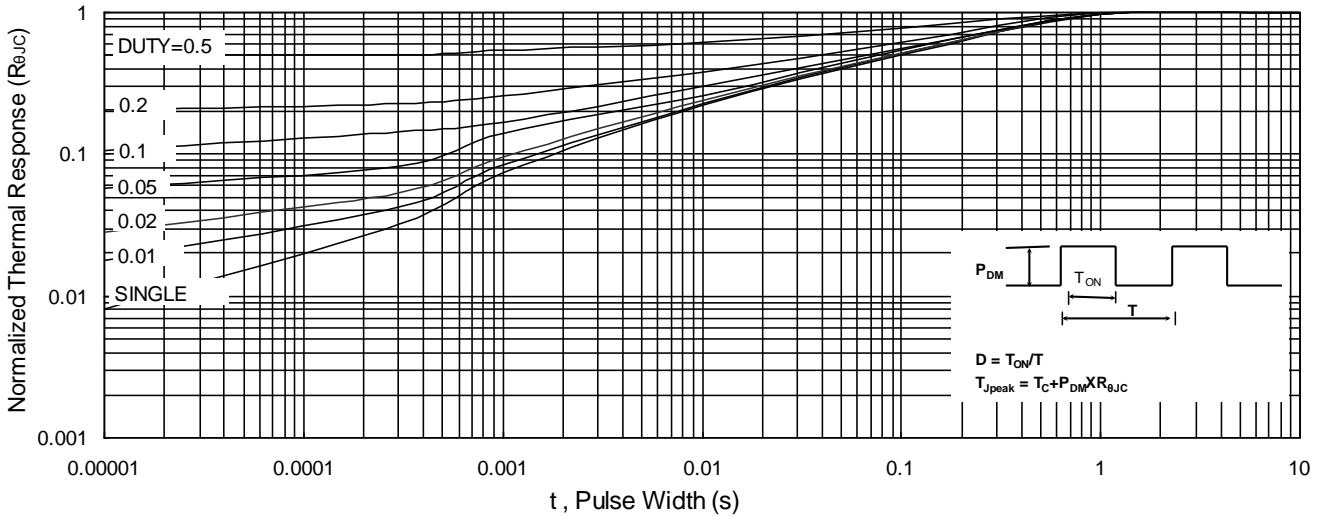

Fig.9 Normalized Maximum Transient Thermal Impedance

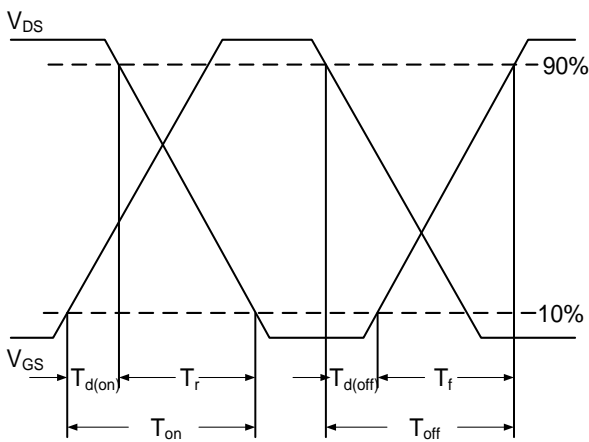

Fig.10 Switching Time Waveform

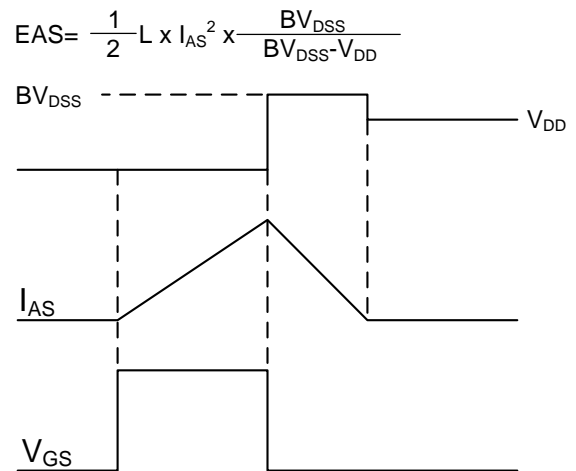

Fig.11 Unclamped Inductive Switching

$$EAS = \frac{1}{2} L \times I_{AS}^2 \times \frac{BV_{DSS}}{BV_{DSS} - V_{DD}}$$



Package Information

TO-220FB-3L

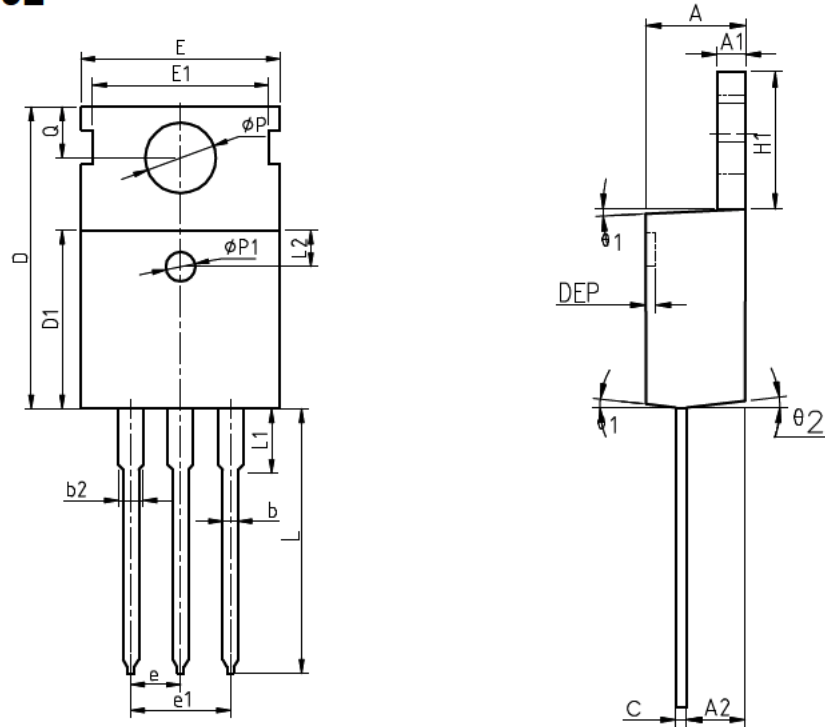

COMMON DIMENSIONS

SYMBOL	MIN	NOM	MAX	MIN	NOM	MAX
A	4.40	4.57	4.70	0.173	0.180	0.185
A1	1.27	1.30	1.33	0.050	0.051	0.052
A2	2.35	2.40	2.50	0.093	0.094	0.098
b	0.77	0.80	0.90	0.030	0.031	0.035
b2	1.17	1.27	1.36	0.046	0.050	0.054
c	0.48	0.50	0.56	0.019	0.020	0.022
D	15.40	15.60	15.80	0.606	0.614	0.622
D1	9.00	9.10	9.20	0.354	0.358	0.362
DEP	0.05	0.10	0.20	0.002	0.004	0.008
E	9.80	10.00	10.20	0.386	0.394	0.402
E1	-	8.70	-	-	0.343	-
E2	9.80	10.00	10.20	0.386	0.394	0.402
e		2.54	BSC		0.100	BSC
e1		5.08	BSC		0.200	BSC
H1	6.40	6.50	6.60	0.252	0.256	0.260
L	12.75	13.50	13.65	0.502	0.531	0.537
L1	-	3.10	3.30	-	0.122	0.130
L2		2.50	REF		0.098	REF
P	3.50	3.60	3.63	0.138	0.142	0.143
P1	3.50	3.60	3.63	0.138	0.142	0.143
Q	2.73	2.80	2.87	0.107	0.110	0.113
θ 1	5°	7°	9°	5°	7°	9°
θ 2	1°	3°	5°	1°	3°	5°
θ 3	1°	3°	5°	1°	3°	5°

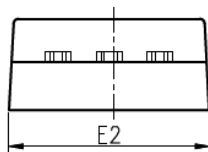

X-ON Electronics

Largest Supplier of Electrical and Electronic Components

Click to view similar products for [MOSFET](#) category:

Click to view products by [HUASHUO](#) manufacturer:

Other Similar products are found below :

[614233C](#) [648584F](#) [MCH3443-TL-E](#) [MCH6422-TL-E](#) [FDPF9N50NZ](#) [FW216A-TL-2W](#) [FW231A-TL-E](#) [APT5010JVR](#) [NTNS3A92PZT5G](#)
[IRF100S201](#) [JANTX2N5237](#) [2SK2464-TL-E](#) [2SK3818-DL-E](#) [FCA20N60_F109](#) [FDZ595PZ](#) [STD6600NT4G](#) [FSS804-TL-E](#) [2SJ277-DL-E](#)
[2SK1691-DL-E](#) [2SK2545\(Q,T\)](#) [D2294UK](#) [405094E](#) [423220D](#) [MCH6646-TL-E](#) [TPCC8103,L1Q\(CM](#) [367-8430-0972-503](#) [VN1206L](#)
[424134F](#) [026935X](#) [051075F](#) [SBVS138LT1G](#) [614234A](#) [715780A](#) [NTNS3166NZT5G](#) [751625C](#) [873612G](#) [IRF7380TRHR](#)
[IPS70R2K0CEAKMA1](#) [RJK60S3DPP-E0#T2](#) [RJK60S5DPK-M0#T0](#) [APT5010JVFR](#) [APT12031JFLL](#) [APT12040JVR](#) [DMN3404LQ-7](#)
[NTE6400](#) [JANTX2N6796U](#) [JANTX2N6784U](#) [JANTXV2N5416U4](#) [SQM110N05-06L-GE3](#) [SIHF35N60E-GE3](#)