



P-Ch 100V Fast Switching MOSFETs

Description

The HSP80P10 uses advanced trench MOSFET technology to provide excellent $R_{DS(ON)}$ and gate charge for use in a wide variety of other applications.

The HSP80P10 meet the RoHS and Green Product requirement, 100% EAS guaranteed with full function reliability approved.

- 100% EAS Guaranteed
- Green Device Available
- Portable equipment and battery powered systems
- Excellent CdV/dt effect decline
- Advanced high cell density Trench technology

Product Summary

V_{DS}	-100	V
$R_{DS(ON),typ}$	20	m Ω
I_D	-80	A

TO220 Pin Configuration

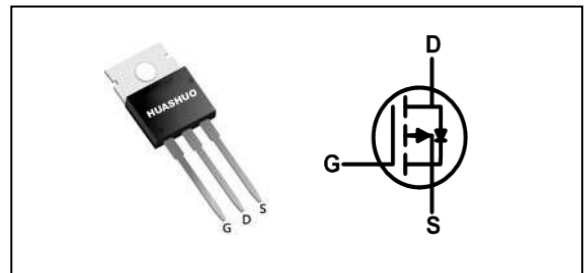

Absolute Maximum Ratings

Symbol	Parameter	Rating	Units
V_{DS}	Drain-Source Voltage	-100	V
V_{GS}	Gate-Source Voltage	± 20	V
$I_D@T_C=25^\circ C$	Continuous Drain Current, V_{GS} @ -10V ₁	-80	A
$I_D@T_C=100^\circ C$	Continuous Drain Current, V_{GS} @ -10V ₁	-57	A
I_{DM}	Pulsed Drain Current ₂	-225	A
EAS	Single Pulse Avalanche Energy ₃	310	mJ
$P_D@T_C=25^\circ C$	Total Power Dissipation ₄	210	W
T_{STG}	Storage Temperature Range	-55 to 150	$^\circ C$
T_J	Operating Junction Temperature Range	-55 to 150	$^\circ C$

Thermal Data

Symbol	Parameter	Typ.	Max.	Unit
$R_{\theta JA}$	Thermal Resistance Junction-Ambient ₁	---	62	$^\circ C/W$
$R_{\theta JC}$	Thermal Resistance Junction-Case ₁	---	0.7	$^\circ C/W$



Electrical Characteristics (T_J=25 °C, unless otherwise noted)

Symbol	Parameter	Conditions	Min.	Typ.	Max.	Unit
BV _{DSS}	Drain-Source Breakdown Voltage	V _{GS} =0V, I _D =-250uA	-100	---	---	V
R _{DS(ON)}	Static Drain-Source On-Resistance ²	V _{GS} =-10V, I _D =-40A	---	20	28	mΩ
		V _{GS} =-4.5V, I _D =-40A	---	24	32	
V _{GS(th)}	Gate Threshold Voltage	V _{GS} =V _{DS} , I _D =-250uA	-1.0	-1.8	-3	V
I _{DSS}	Drain-Source Leakage Current	V _{DS} =-100V, V _{GS} =0V, T _J =25°C	---	---	-50	uA
I _{GSS}	Gate-Source Leakage Current	V _{GS} =±20V, V _{DS} =0V	---	---	±100	nA
R _g	Gate Resistance	V _{GS} =0V, V _{DS} =0V, F=1MHz	---	4.7	---	Ω
g _{fs}	Forward Transconductance	V _{DS} =-10V, I _D =-10A	---	32	---	S
Q _g	Total Gate Charge	V _{DS} =-50V, V _{GS} =-10V, I _D =-20A	---	180	---	nC
Q _{gs}	Gate-Source Charge		---	44	---	
Q _{gd}	Gate-Drain Charge		---	29	---	
T _{d(on)}	Turn-On Delay Time	V _{DD} =-50V, V _{GS} =-10V, R _G =4Ω, I _D =-20A	---	16	---	ns
T _r	Rise Time		---	91	---	
T _{d(off)}	Turn-Off Delay Time		---	208	---	
T _f	Fall Time		---	110	---	
C _{iss}	Input Capacitance	V _{DS} =-50V, V _{GS} =0V, f=1MHz	---	11660	---	pF
C _{oss}	Output Capacitance		---	289	---	
C _{rss}	Reverse Transfer Capacitance		---	99	---	

Diode Characteristics

Symbol	Parameter	Conditions	Min.	Typ.	Max.	Unit
I _s	Continuous Source Current ^{1,5}	V _G =V _D =0V, Force Current	---	---	-80	A
V _{SD}	Diode Forward Voltage ²	V _{GS} =0V, I _S =-40A, T _J =25°C	---	---	-1.3	V
t _{rr}	Reverse Recovery Time	I _F =-40A, di/dt=-100A/μs,	---	31.2	---	nS
Q _{rr}	Reverse Recovery Charge	T _J =25°C	---	45	---	nC

Note :

- 1.The data tested by surface mounted on a 1 inch² FR-4 board with 2OZ copper.
- 2.The data tested by pulsed , pulse width ≤ 300us , duty cycle ≤ 2%
- 3.The EAS data shows Max. rating . The test condition is V_{DD}=-80V, V_{GS}=-10V, L=0.3mH
- 4.The power dissipation is limited by 150°C junction temperature
- 5.The data is theoretically the same as I_D and I_{DM} , in real applications , should be limited by total power dissipation.



Typical Characteristics

Figure 1: Power Dissipation

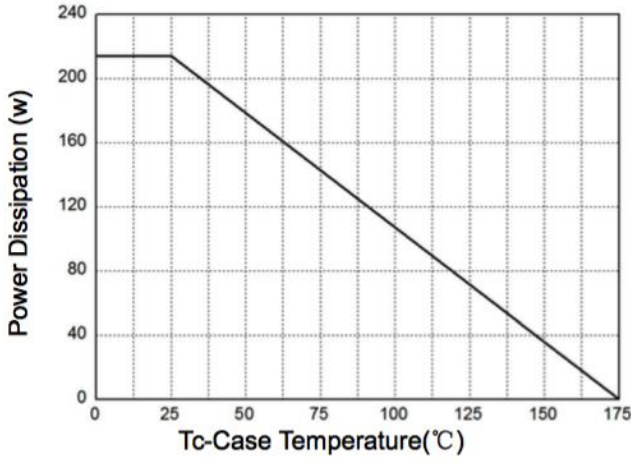

Figure 2: Drain Current

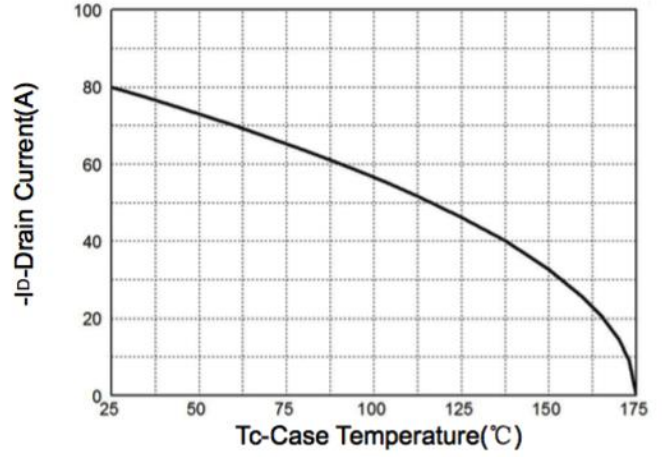

Figure 3: Safe Operation Area

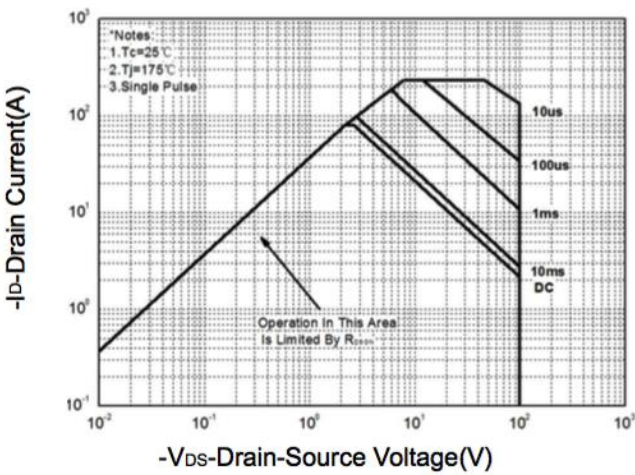

Figure 4: Thermal Transient Impedance

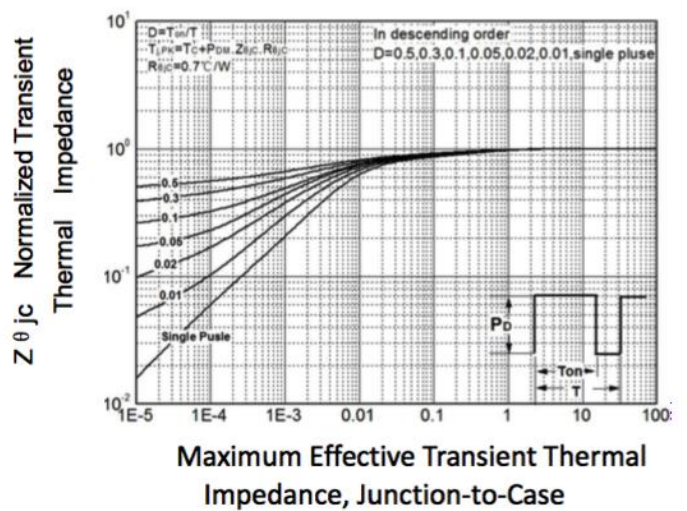

Figure 5: Output Characteristics

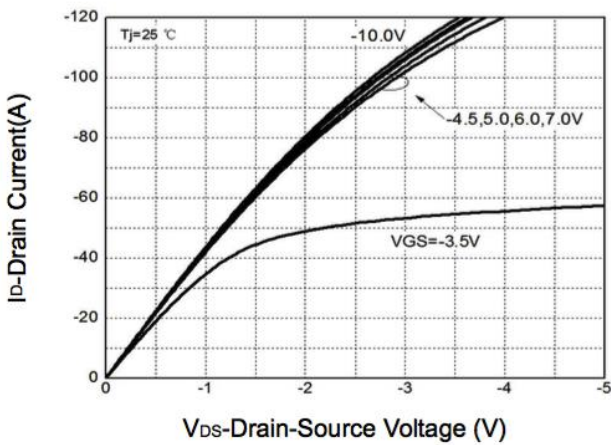
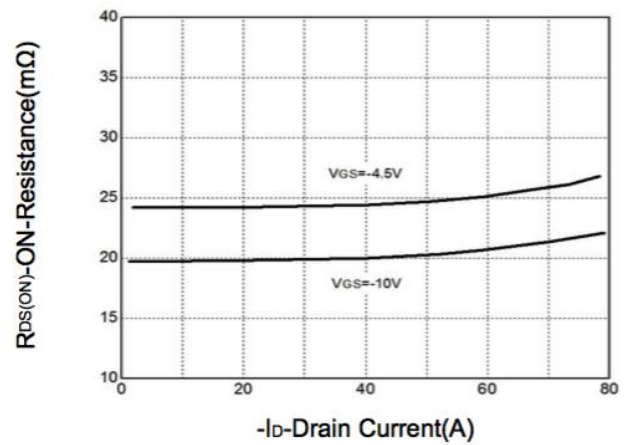

Figure 6: Drain-Source On Resistance





P-Ch 100V Fast Switching MOSFETs

Figure 7: On-Resistance vs. Temperature

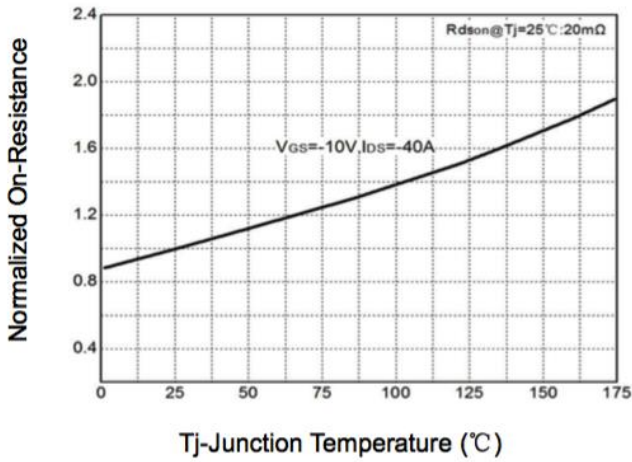

Figure 8: Source-Drain Diode Forward

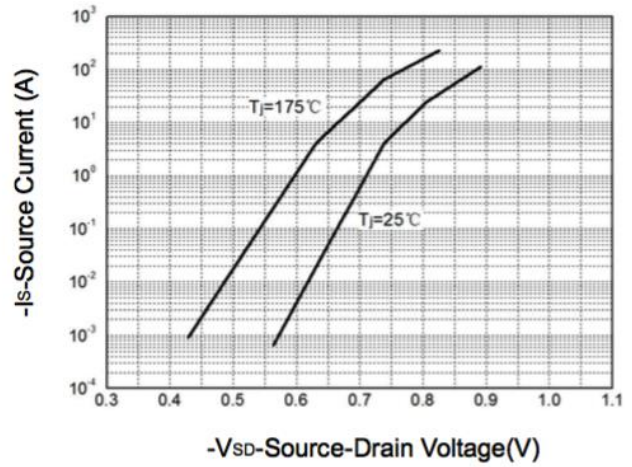

Figure 9: Capacitance Characteristics

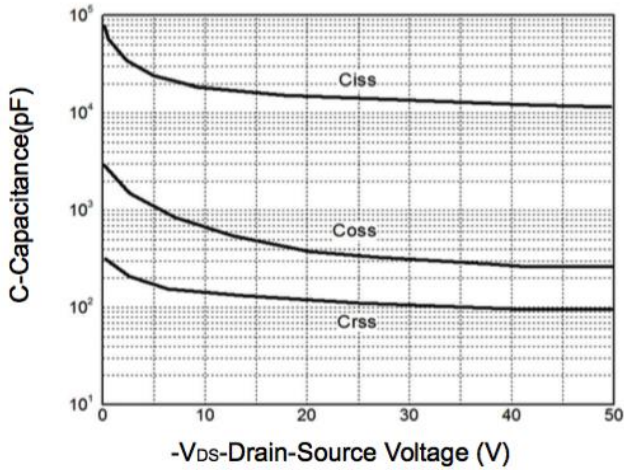

Figure 10: Gate Charge Characteristics

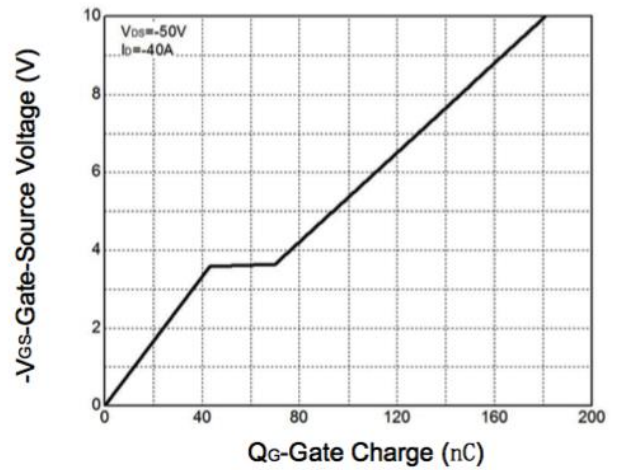

Fig.11 Switching Time Waveform

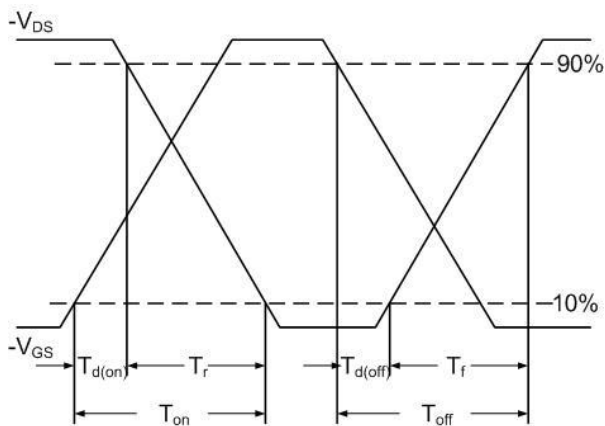
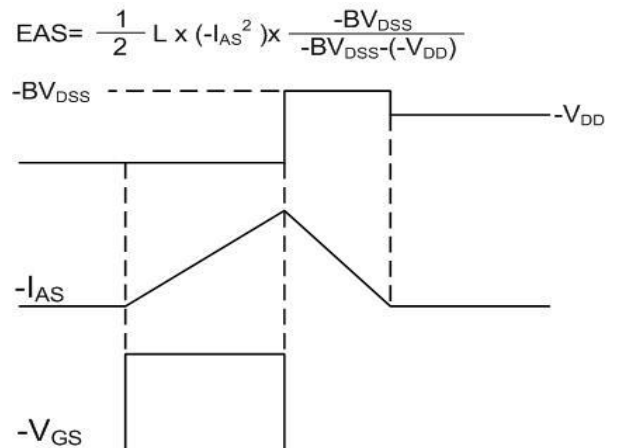
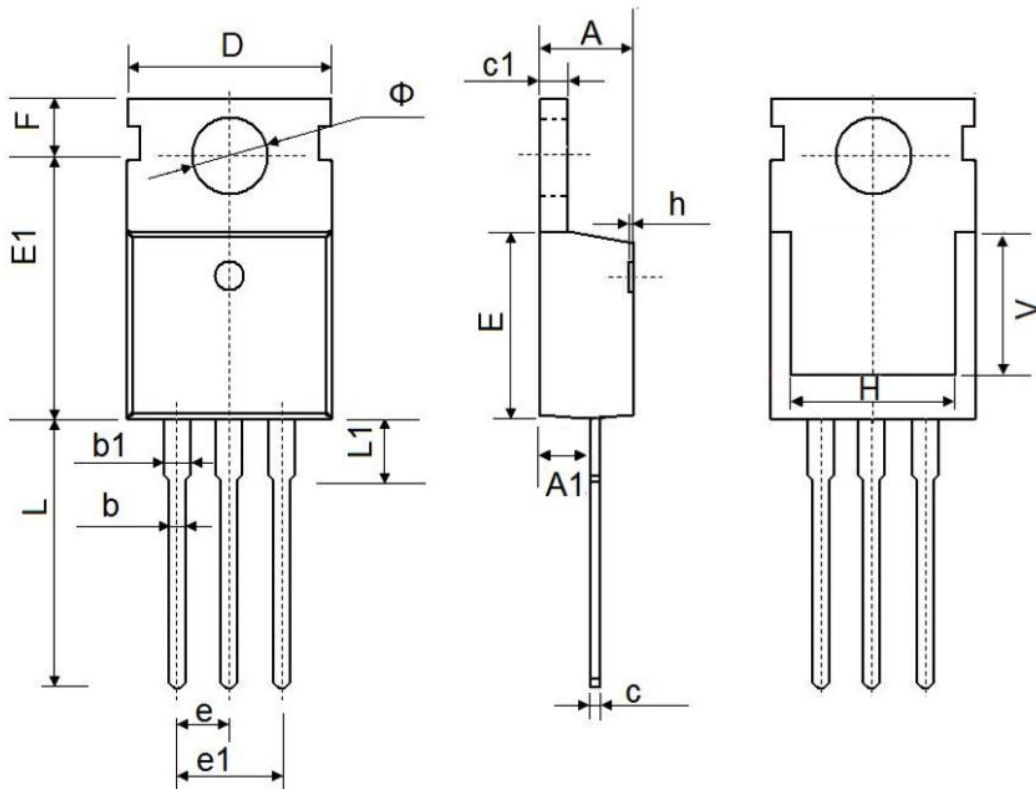

Fig.12 Unclamped Inductive Waveform





TO-220 Package Information



Symbol	Dimensions In Millimeters		Dimensions In Inches	
	Min.	Max.	Min.	Max.
A	4.300	4.700	0.169	0.185
A1	2.200	2.600	0.087	0.102
b	0.700	0.950	0.028	0.037
b1	1.170	1.410	0.046	0.056
c	0.450	0.650	0.018	0.026
c1	1.200	1.400	0.047	0.055
D	9.600	10.400	0.378	0.409
E	8.8500	9.750	0.348	0.384
E1	12.650	12.950	0.498	0.510
e	2.540 TYP.		0.100TYP.	
e1	4.980	5.180	0.196	0.204
F	2.650	2.950	0.104	0.116
H	7.900	8.100	0.311	0.319
h	0.000	0.300	0.000	0.012
L	12.750	14.300	0.502	0.563
L1	2.850	3.950	0.112	0.156
V	7.500 REF.		0.295 REF.	
Φ	3.400	4.000	0.134	0.157

X-ON Electronics

Largest Supplier of Electrical and Electronic Components

Click to view similar products for [MOSFET](#) category:

Click to view products by [HUASHUO](#) manufacturer:

Other Similar products are found below :

[614233C](#) [648584F](#) [NTNS3A92PZT5G](#) [IRFD120](#) [IRFF430](#) [JANTX2N5237](#) [2N7000](#) [2SK2464-TL-E](#) [FCA20N60_F109](#) [FDZ595PZ](#) [AOD464](#)
[2SK2267\(Q\)](#) [2SK2545\(Q,T\)](#) [405094E](#) [423220D](#) [MIC4420CM-TR](#) [VN1206L](#) [614234A](#) [715780A](#) [SSM6J414TU,LF\(T](#) [751625C](#)
[IPP60R600P6XKSA1](#) [RJK60S5DPK-M0#T0](#) [PSMN4R2-30MLD](#) [TK31J60W5,S1VQ\(O](#) [2SK2614\(TE16L1,Q\)](#) [DMN1017UCP3-7](#)
[EFC2J004NUZTDG](#) [FCAB21350L1](#) [P85W28HP2F-7071](#) [DMN1053UCP4-7](#) [NTE2384](#) [NTE2969](#) [NTE6400A](#) [DMN61D9UWQ-13](#)
[US6M2GTR](#) [DMN31D5UDJ-7](#) [SSM6P54TU,LF](#) [DMP22D4UFO-7B](#) [IPS60R3K4CEAKMA1](#) [DMN1006UCA6-7](#) [DMN16M9UCA6-7](#)
[STF5N65M6](#) [STU5N65M6](#) [C3M0021120D](#) [DMN13M9UCA6-7](#) [BSS340NWH6327XTSA1](#) [MCM3400A-TP](#) [DMTH10H4M6SPS-13](#)
[IRF40SC240ARMA1](#)