

### Description

The HSU100P03 is the high cell density trenched P-ch MOSFETs, which provide excellent R<sub>DS(ON)</sub> and gate charge for most of the synchronous buck converter applications.

The HSU100P03 meet the RoHS and Green Product requirement, 100% EAS guaranteed with full function reliability approved.

- Super Low Gate Charge
- 100% EAS Guaranteed
- Green Device Available
- Excellent CdV/dt effect decline
- Advanced high cell density Trench technology

### Product Summary

V <sub>DS</sub>	-30	V
R <sub>DS(ON),typ</sub>	4	mΩ
I <sub>D</sub>	-100	A

### TO252 Pin Configuration

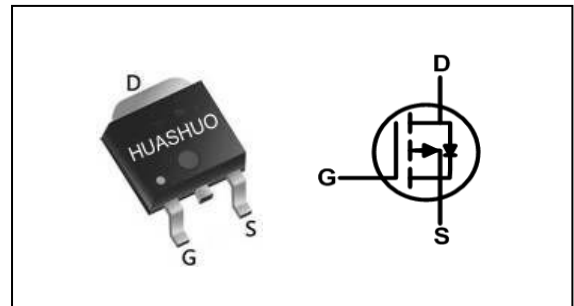

### Absolute Maximum Ratings

Symbol	Parameter	Rating	Units
V <sub>DS</sub>	Drain-Source Voltage	-30	V
V <sub>GS</sub>	Gate-Source Voltage	±20	V
I <sub>D</sub> @T <sub>C</sub> =25°C	Continuous Drain Current, V <sub>GS</sub> @ -10V <sub>1,6</sub>	-100	A
I <sub>D</sub> @T <sub>C</sub> =100°C	Continuous Drain Current, V <sub>GS</sub> @ -10V <sub>1,6</sub>	-65	A
I <sub>DM</sub>	Pulsed Drain Current <sub>2</sub>	-400	A
EAS	Single Pulse Avalanche Energy <sub>3</sub>	210	mJ
I <sub>AS</sub>	Avalanche Current	-30	A
P <sub>D</sub> @T <sub>C</sub> =25°C	Total Power Dissipation <sub>4</sub>	105	W
T <sub>STG</sub>	Storage Temperature Range	-55 to 175	°C
T <sub>J</sub>	Operating Junction Temperature Range	-55 to 175	°C

### Thermal Data

Symbol	Parameter	Typ.	Max.	Unit
R <sub>θJA</sub>	Thermal Resistance Junction-ambient <sub>1</sub> (t ≤ 10S)	---	20	°C/W
	Thermal Resistance Junction-ambient <sub>1</sub> (Steady State)	---	50	°C/W
R <sub>θJC</sub>	Thermal Resistance Junction-case <sub>1</sub>	---	1.45	°C/W



**Electrical Characteristics (T<sub>J</sub>=25 °C, unless otherwise noted)**

Symbol	Parameter	Conditions	Min.	Typ.	Max.	Unit
B <sub>VDS</sub>	Drain-Source Breakdown Voltage	V <sub>GS</sub> =0V, I <sub>D</sub> =-250uA	-30	---	---	V
R <sub>DS(ON)</sub>	Static Drain-Source On-Resistance <sup>2</sup>	V <sub>GS</sub> =-10V, I <sub>D</sub> =-20A	---	4	5.3	mΩ
		V <sub>GS</sub> =-4.5V, I <sub>D</sub> =-15A	---	5.7	8.2	mΩ
V <sub>GS(th)</sub>	Gate Threshold Voltage	V <sub>GS</sub> =V <sub>DS</sub> , I <sub>D</sub> =-250uA	-1.0	---	-2.5	V
I <sub>DSS</sub>	Drain-Source Leakage Current	V <sub>DS</sub> =-24V, V <sub>GS</sub> =0V, T <sub>J</sub> =25°C	---	---	-1	uA
		V <sub>DS</sub> =-24V, V <sub>GS</sub> =0V, T <sub>J</sub> =55°C	---	---	-5	
I <sub>GSS</sub>	Gate-Source Leakage Current	V <sub>GS</sub> =±20V, V <sub>DS</sub> =0V	---	---	±100	nA
Q <sub>g</sub>	Total Gate Charge (-10V)	V <sub>DS</sub> =-15V, V <sub>GS</sub> =-10V, I <sub>D</sub> =-30A	---	45	---	nC
Q <sub>gs</sub>	Gate-Source Charge		---	9	---	
Q <sub>gd</sub>	Gate-Drain Charge		---	12	---	
T <sub>d(on)</sub>	Turn-On Delay Time	V <sub>DD</sub> =-15V, V <sub>GS</sub> =-10V, R <sub>G</sub> =3.3Ω, I <sub>D</sub> =-30A	---	17	---	ns
T <sub>r</sub>	Rise Time		---	19	---	
T <sub>d(off)</sub>	Turn-Off Delay Time		---	68	---	
T <sub>f</sub>	Fall Time		---	23	---	
C <sub>iss</sub>	Input Capacitance	V <sub>DS</sub> =-15V, V <sub>GS</sub> =0V, f=1MHz	---	9300	---	pF
C <sub>oss</sub>	Output Capacitance		---	989	---	
C <sub>rss</sub>	Reverse Transfer Capacitance		---	700	---	

**Diode Characteristics**

Symbol	Parameter	Conditions	Min.	Typ.	Max.	Unit
I <sub>S</sub>	Continuous Source Current <sup>1,5</sup>	V <sub>G</sub> =V <sub>D</sub> =0V, Force Current	---	---	-100	A
V <sub>SD</sub>	Diode Forward Voltage <sup>2</sup>	V <sub>GS</sub> =0V, I <sub>S</sub> =-1A, T <sub>J</sub> =25°C	---	---	-1.2	V

Note :

- 1.The data tested by surface mounted on a 1 inch<sup>2</sup> FR-4 board with 2OZ copper.
- 2.The data tested by pulsed , pulse width ≤ 300us , duty cycle ≤ 2%
- 3.The EAS data shows Max. rating . The test condition is V<sub>DD</sub>=-15V, V<sub>GS</sub>=-10V, L=0.5mH, R<sub>G</sub>=25R, I<sub>AS</sub>=-30A
- 4.The power dissipation is limited by 150°C junction temperature
- 5.The data is theoretically the same as I<sub>D</sub> and I<sub>DM</sub> , in real applications , should be limited by total power dissipation
- 6.The maximum current rating is package limited.

**Typical Characteristics**

**Figure 1: Power Dissipation**

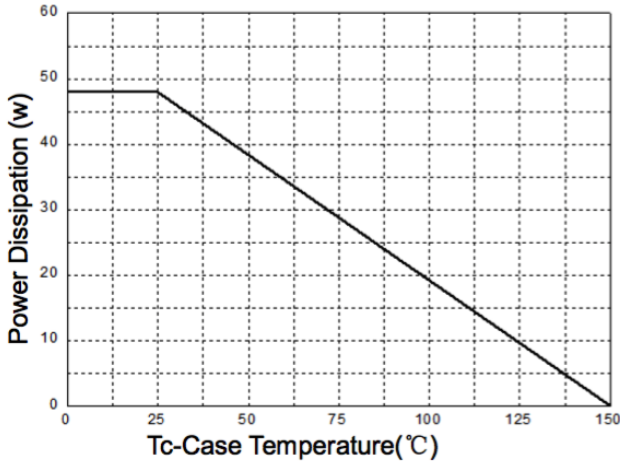

**Figure 2: Drain Current**

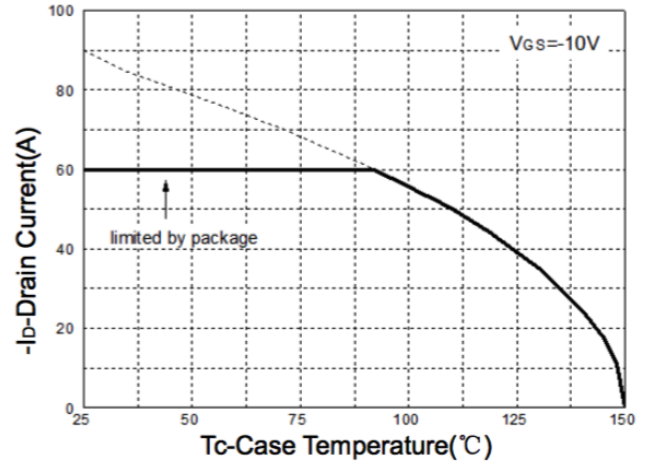

**Figure 3: Safe Operation Area**

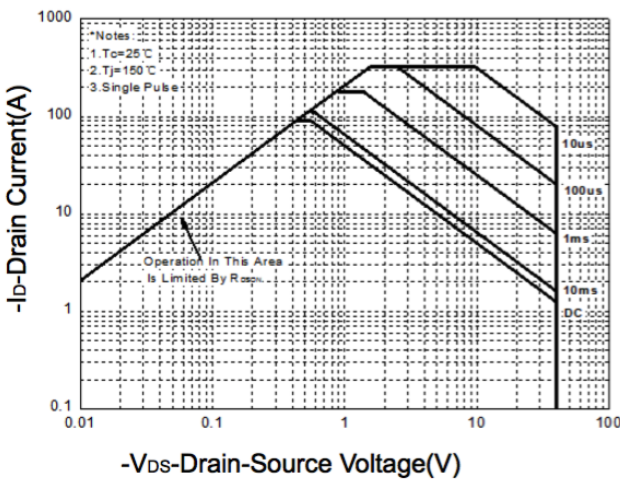

**Figure 4: Thermal Transient Impedance**

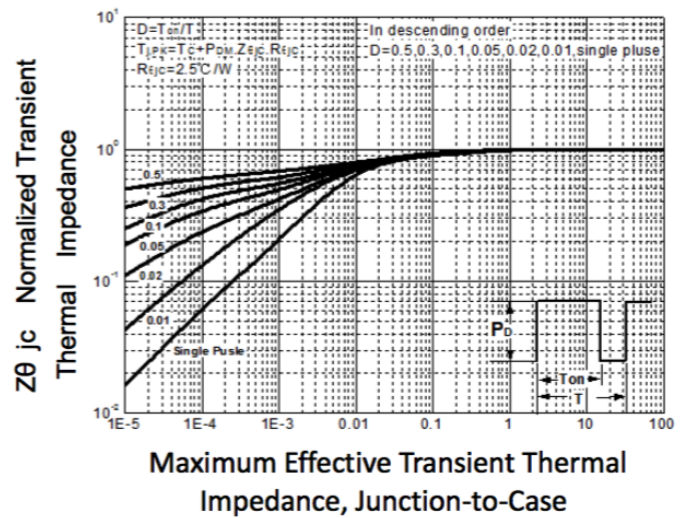

**Figure 5: Output Characteristics**

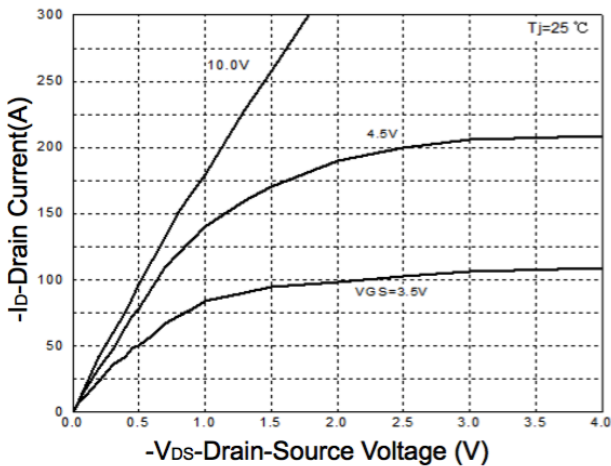

**Figure 6: Drain-Source On Resistance**

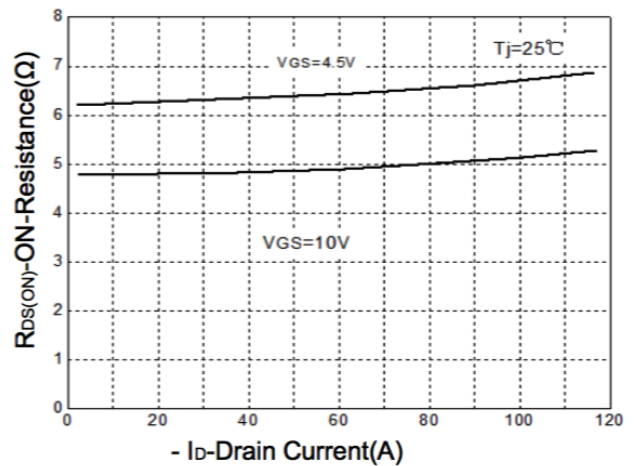



Figure 7: On-Resistance vs. Temperature

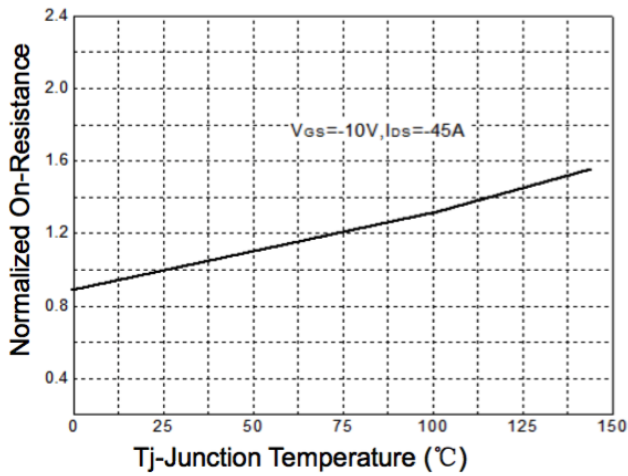

Figure 8: Source-Drain Diode Forward

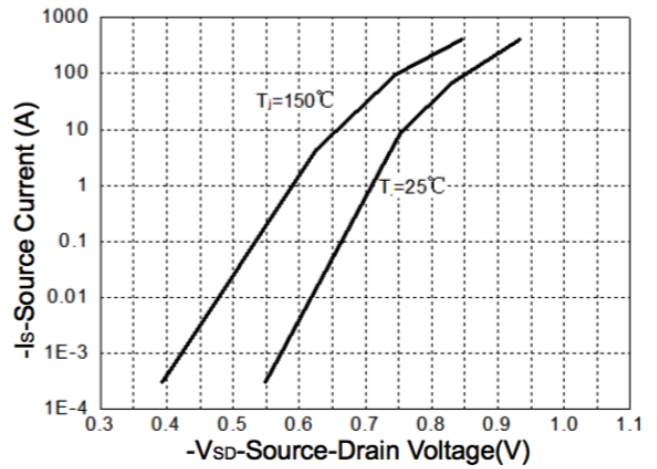

Figure 9: Capacitance Characteristics

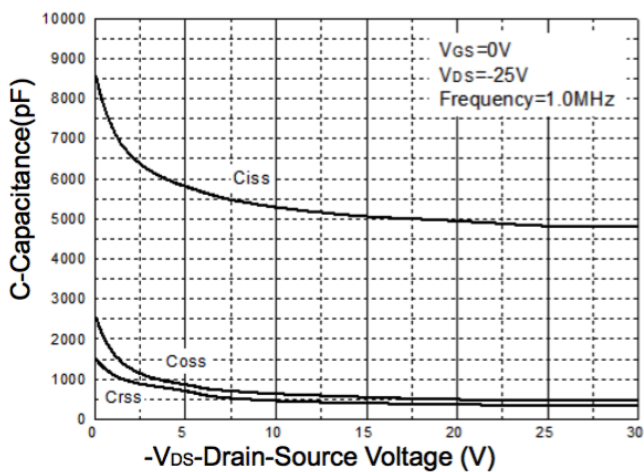
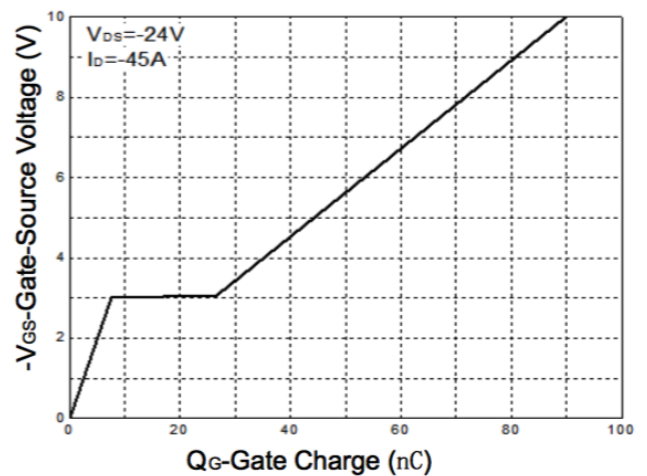

Figure 10: Gate Charge Characteristics





## Ordering Information

Part Number	Package code	Packaging
HSU100P03	TO252-2	2500/Tape&Reel

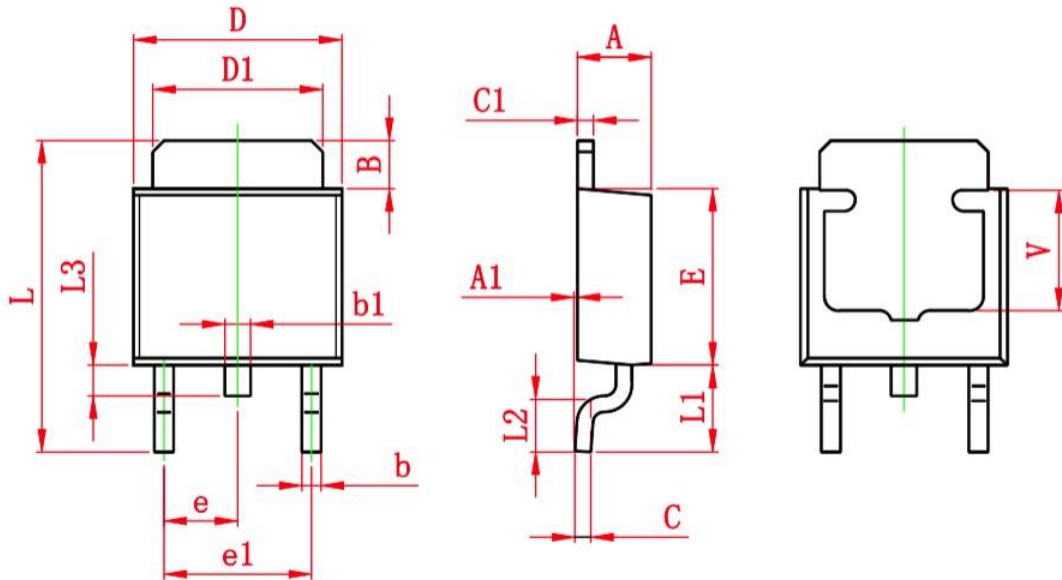

Symbol	Dimensions In Millimeters		Dimensions In Inches	
	Min.	Max.	Min.	Max.
A	2.200	2.400	0.087	0.094
A1	0.000	0.127	0.000	0.005
B	1.350	1.650	0.053	0.065
b	0.500	0.700	0.020	0.028
b1	0.700	0.900	0.028	0.035
c	0.430	0.580	0.017	0.023
c1	0.430	0.580	0.017	0.023
D	6.350	6.650	0.250	0.262
D1	5.200	5.400	0.205	0.213
E	5.400	5.700	0.213	0.224
e	2.300 TYP.		0.091 TYP.	
e1	4.500	4.700	0.177	0.185
L	9.500	9.900	0.374	0.390
L1	2.550	2.900	0.100	0.114
L2	1.400	1.780	0.055	0.070
L3	0.600	0.900	0.024	0.035
V	3.800 REF.		0.150 REF.	

## X-ON Electronics

Largest Supplier of Electrical and Electronic Components

*Click to view similar products for [MOSFET](#) category:*

*Click to view products by [HUASHUO](#) manufacturer:*

Other Similar products are found below :

[614233C](#) [648584F](#) [NTNS3A92PZT5G](#) [IRFD120](#) [IRFF430](#) [JANTX2N5237](#) [2N7000](#) [2SK2464-TL-E](#) [FCA20N60\\_F109](#) [FDZ595PZ](#) [AOD464](#)  
[2SK2267\(Q\)](#) [2SK2545\(Q,T\)](#) [405094E](#) [423220D](#) [MIC4420CM-TR](#) [VN1206L](#) [614234A](#) [715780A](#) [SSM6J414TU,LF\(T](#) [751625C](#)  
[IPP60R600P6XKSA1](#) [RJK60S5DPK-M0#T0](#) [PSMN4R2-30MLD](#) [TK31J60W5,S1VQ\(O](#) [2SK2614\(TE16L1,Q\)](#) [DMN1017UCP3-7](#)  
[EFC2J004NUZTDG](#) [FCAB21350L1](#) [P85W28HP2F-7071](#) [DMN1053UCP4-7](#) [NTE2384](#) [NTE2969](#) [NTE6400A](#) [DMN61D9UWQ-13](#)  
[US6M2GTR](#) [DMN31D5UDJ-7](#) [SSM6P54TU,LF](#) [DMP22D4UFO-7B](#) [IPS60R3K4CEAKMA1](#) [DMN1006UCA6-7](#) [DMN16M9UCA6-7](#)  
[STF5N65M6](#) [STU5N65M6](#) [C3M0021120D](#) [DMN13M9UCA6-7](#) [BSS340NWH6327XTSA1](#) [MCM3400A-TP](#) [DMTH10H4M6SPS-13](#)  
[IRF40SC240ARMA1](#)