

Description

The HSU4119 is the high cell density trenched P-ch MOSFETs, which provide excellent RDSON and gate charge for most of the synchronous buck converter applications.

The HSU4119 meet the RoHS and Green Product requirement, 100% EAS guaranteed with full function reliability approved.

- Super Low Gate Charge
- 100% EAS Guaranteed
- Green Device Available
- Excellent CdV/dt effect decline
- Advanced high cell density Trench technology

Product Summary

V_{DS}	-40	V
$R_{DS(ON),typ}$	3.5	m Ω
I_D	-120	A

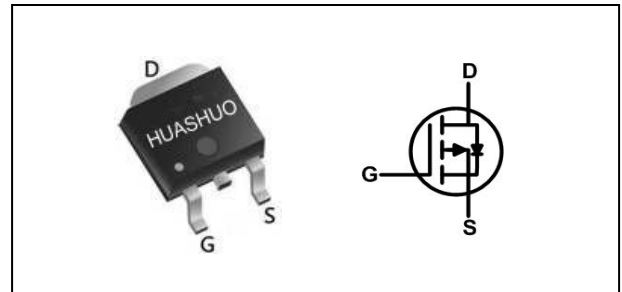
TO-252 Pin Configuration

Absolute Maximum Ratings

Symbol	Parameter	Rating	Units
V_{DS}	Drain-Source Voltage	-40	V
V_{GS}	Gate-Source Voltage	± 20	V
$I_D@T_C=25^\circ C$	Continuous Drain Current, $V_{GS} @ -10V^{1,6}$	-120	A
$I_D@T_C=100^\circ C$	Continuous Drain Current, $V_{GS} @ -10V^{1,6}$	-90	A
I_{DM}	Pulsed Drain Current ²	-480	A
EAS	Single Pulse Avalanche Energy ³	1250	mJ
I_{AS}	Avalanche Current	-70	A
$P_D@T_C=25^\circ C$	Total Power Dissipation ⁴	135	W
T_{STG}	Storage Temperature Range	-55 to 150	$^\circ C$
T_J	Operating Junction Temperature Range	-55 to 150	$^\circ C$

Thermal Data

Symbol	Parameter	Typ.	Max.	Unit
$R_{\theta JA}$	Thermal Resistance Junction-ambient ¹ ($t \leq 10S$)	---	20	$^\circ C/W$
	Thermal Resistance Junction-ambient ¹ (Steady State)	---	62	$^\circ C/W$
$R_{\theta JC}$	Thermal Resistance Junction-case ¹	---	1.8	$^\circ C/W$



Electrical Characteristics (T_J=25 °C, unless otherwise noted)

Symbol	Parameter	Conditions	Min.	Typ.	Max.	Unit
BV _{DSS}	Drain-Source Breakdown Voltage	V _{GS} =0V, I _D =-250uA	-40	---	---	V
R _{DS(ON)}	Static Drain-Source On-Resistance ²	V _{GS} =-10V, I _D =-30A	---	3.5	4.0	mΩ
		V _{GS} =-4.5V, I _D =-20A	---	4.5	5.3	mΩ
V _{GS(th)}	Gate Threshold Voltage	V _{GS} =V _{DS} , I _D =-250uA	-1.0	---	-2.5	V
I _{DSS}	Drain-Source Leakage Current	V _{DS} =-40V, V _{GS} =0V, T _J =25°C	---	---	-1	uA
		V _{DS} =-40V, V _{GS} =0V, T _J =125°C	---	---	-100	uA
I _{GSS}	Gate-Source Leakage Current	V _{GS} = ± 20V, V _{DS} =0V	---	---	± 100	nA
R _g	Gate resistance	V _{DS} =0V, V _{GS} =0V, f=1MHz		1.7		Ω
Q _g	Total Gate Charge (-10V)	V _{DS} =-20V, V _{GS} =-10V, I _D =-20A	---	190	---	nC
Q _{gs}	Gate-Source Charge		---	24	---	
Q _{gd}	Gate-Drain Charge		---	38	---	
T _{d(on)}	Turn-On Delay Time	V _{DD} =-20V, V _{GS} =-10V, R _G =3Ω, I _D =-10A	---	18	---	ns
T _r	Rise Time		---	3.6	---	
T _{d(off)}	Turn-Off Delay Time		---	21	---	
T _f	Fall Time		---	39	---	
C _{iss}	Input Capacitance	V _{DS} =-20V, V _{GS} =0V, f=1MHz	---	10700	---	pF
C _{oss}	Output Capacitance		---	780	---	
C _{rss}	Reverse Transfer Capacitance		---	660	---	

Diode Characteristics

Symbol	Parameter	Conditions	Min.	Typ.	Max.	Unit
I _S	Continuous Source Current ^{1,5}	V _G =V _D =0V, Force Current	---	---	-120	A
V _{SD}	Diode Forward Voltage ²	V _{GS} =0V, I _S =-20A, T _J =25°C	---	---	-1.2	V
t _{rr}	Reverse Recovery Time	I _F =-20A, di/dt=100A/μs,	---	52	---	nS
Q _{rr}	Reverse Recovery Charge	T _J =25°C	---	128	---	nC

Note :

- 1.The data tested by surface mounted on a 1 inch² FR-4 board with 2OZ copper.
- 2.The data tested by pulsed , pulse width ≤ 300us , duty cycle ≤ 2%
- 3.The EAS data shows Max. rating . The test condition is V_{DD}=-40V,V_{GS}=-10V,L=0.5mH,I_{AS}=-70A
- 4.The power dissipation is limited by 150°C junction temperature
- 5.The data is theoretically the same as I_D and I_{DM} , in real applications , should be limited by total power dissipation
- 6.The maximum current rating is package limited.



Typical Characteristics

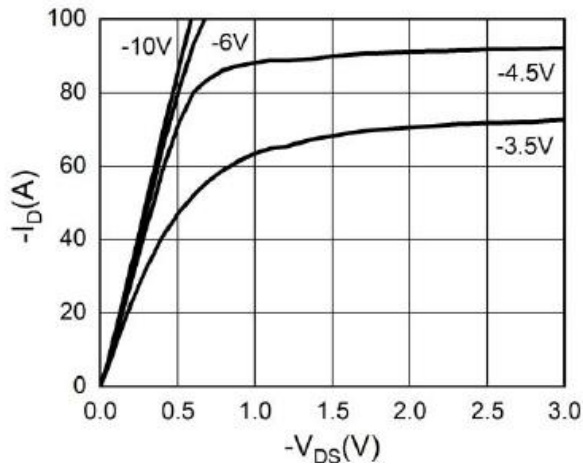

Fig.1 Output Characteristics

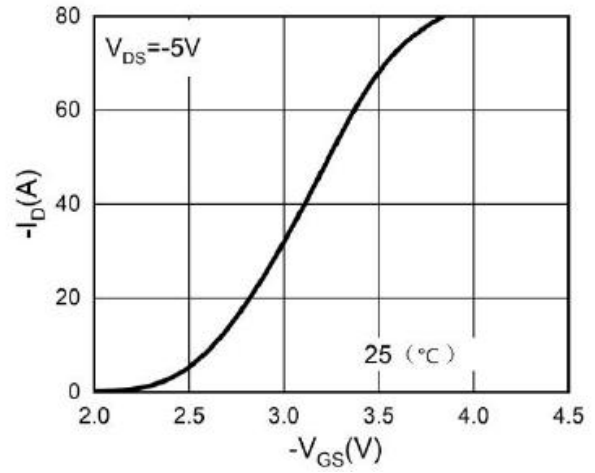

Fig.2 Transfer Characteristics

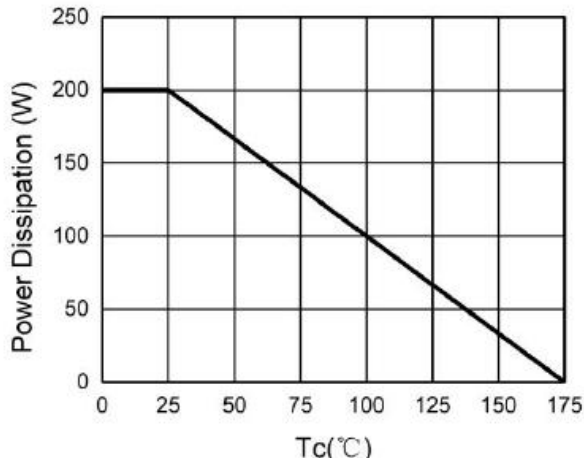

Fig.3 Power Dissipation

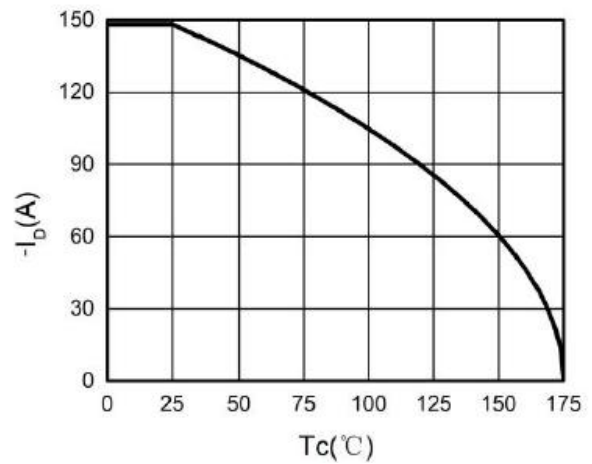

Fig.4 Drain Current

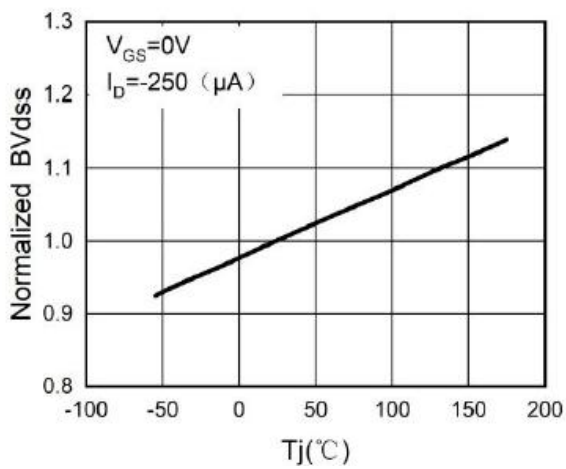

Fig.5 BV_{dss} vs Junction Temperature

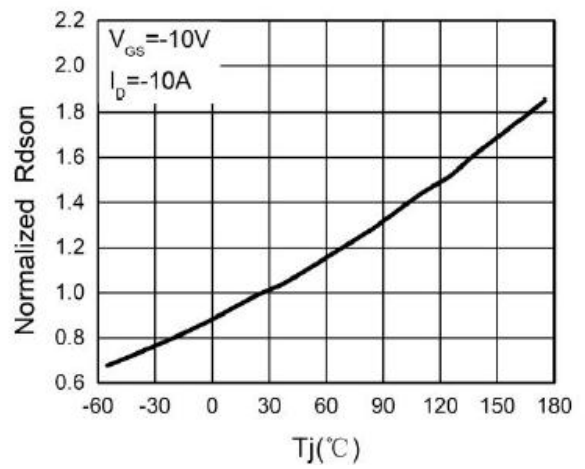
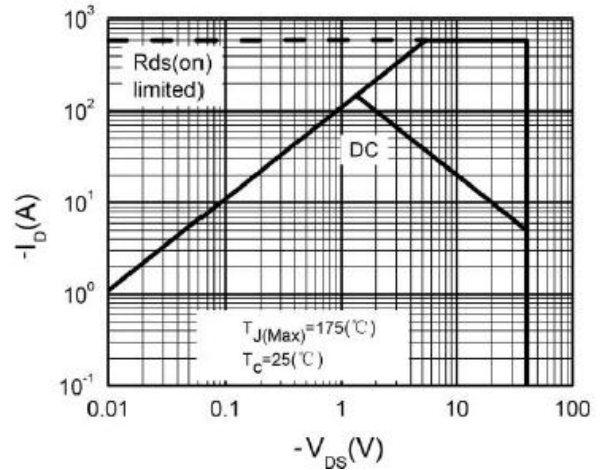
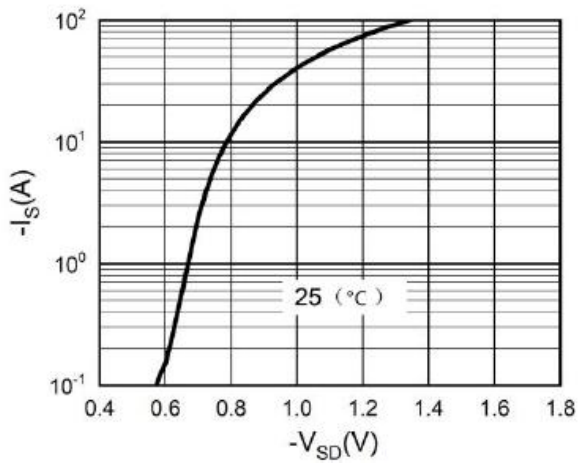
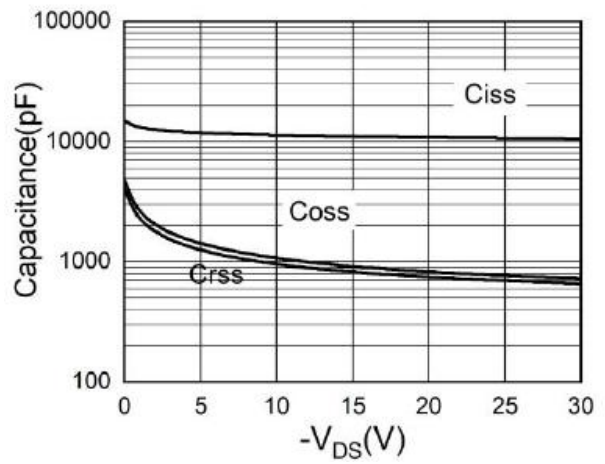
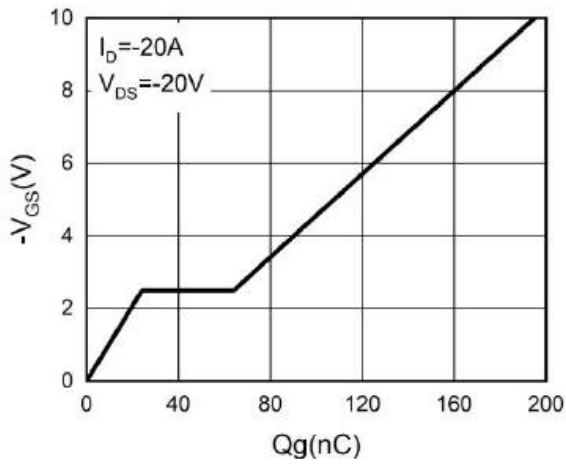
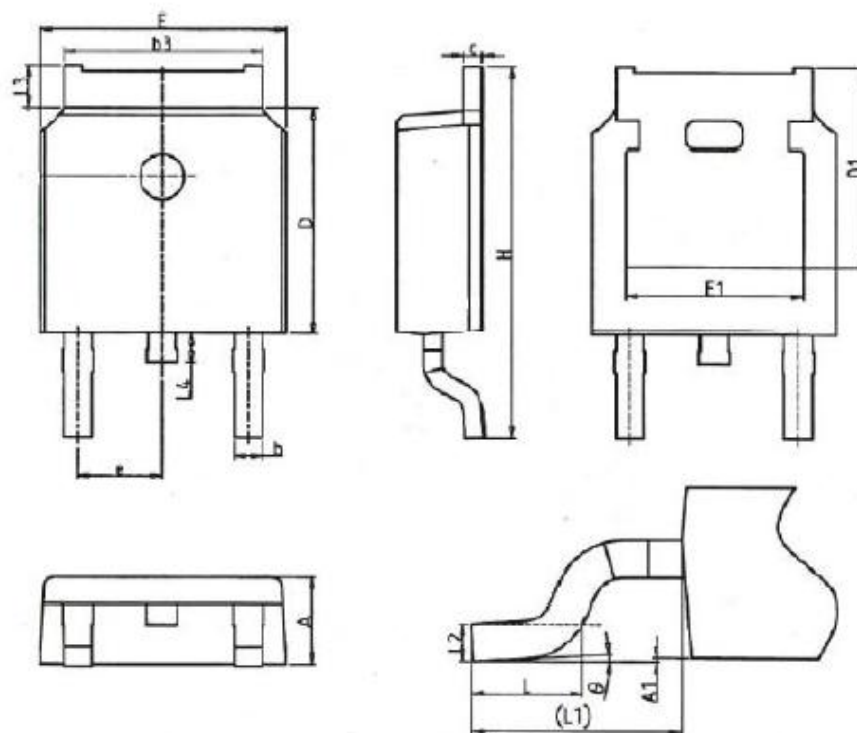

Fig.6 $R_{ds(on)}$ vs Junction Temperature





TO252-2L Package Outline



SYMBOLS	MILLIMETERS		INCHES	
	MIN	MAX	MIN	MAX
A	2.18	2.40	0.086	0.095
A1	-	0.2	-	0.008
b	0.68	0.9	0.026	0.036
b3	4.95	5.46	0.194	0.215
c	0.43	0.89	0.017	0.035
D	5.97	6.22	0.235	0.245
D1	5.300REF		0.209REF	
E	6.35	6.73	0.250	0.265
E1	4.32	--	0.170	-
e	2.286BSC		0.09BSC	
H	9.4	10.5	0.370	0.413
L	1.38	1.78	0.054	0.070
L1	2.90REF		0.114REF	
L2	0.51BSC		0.020BSC	
L3	0.88	1.28	0.034	0.050
L4	0.5	1	0.019	0.039
∅	0°	8°	0°	8°

X-ON Electronics

Largest Supplier of Electrical and Electronic Components

Click to view similar products for [MOSFET](#) category:

Click to view products by [HUASHUO](#) manufacturer:

Other Similar products are found below :

[IRFD120](#) [IRFY240C](#) [JANTX2N5237](#) [2SK2267\(Q\)](#) [BUK455-60A/B](#) [MIC4420CM-TR](#) [VN1206L](#) [NDP4060](#) [SI4482DY](#)
[IPS70R2K0CEAKMA1](#) [SQD23N06-31L-GE3](#) [TK16J60W,S1VQ\(O](#) [2SK2614\(TE16L1,Q\)](#) [DMN1017UCP3-7](#) [EFC2J004NUZTDG](#)
[DMN1053UCP4-7](#) [SQJ469EP-T1-GE3](#) [NTE2384](#) [DMC2700UDMQ-7](#) [DMN2080UCB4-7](#) [DMN61D9UWQ-13](#) [US6M2GTR](#)
[DMN31D5UDJ-7](#) [DMP22D4UFO-7B](#) [DMN1006UCA6-7](#) [DMN16M9UCA6-7](#) [STF5N65M6](#) [IRF40H233XTMA1](#) [STU5N65M6](#)
[DMN6022SSD-13](#) [DMN13M9UCA6-7](#) [DMTH10H4M6SPS-13](#) [DMN2990UFB-7B](#) [IPB80P04P405ATMA2](#) [2N7002W-G](#) [MCAC30N06Y-](#)
[TP](#) [MCQ7328-TP](#) [NTMC083NP10M5L](#) [NVMFS2D3P04M8LT1G](#) [BXP7N65D](#) [BXP4N65F](#) [AOL1454G](#) [WMJ80N60C4](#) [BXP2N20L](#)
[BXP2N65D](#) [BXT1150N10J](#) [BXT1700P06M](#) [TSM60NB380CP](#) [ROG](#) [RQ7L055BGTCR](#) [DMNH15H110SK3-13](#)