

Description

The HSU5P20 is the high cell density trenched P-ch MOSFETs, which provides excellent R_{DS(ON)} and efficiency for most of the small power switching and load switch applications. The HSU5P20 meets the RoHS and Green Product requirement with full function reliability approved.

- Super Low Gate Charge
- Excellent Cdv/dt effect decline
- Green Device Available
- Advanced high cell density Trench technology

Product Summary

V _{DS}	-200	V
R _{DS(ON),Max}	2.4	Ω
I _D	-5	A

TO-252 Pin Configuration

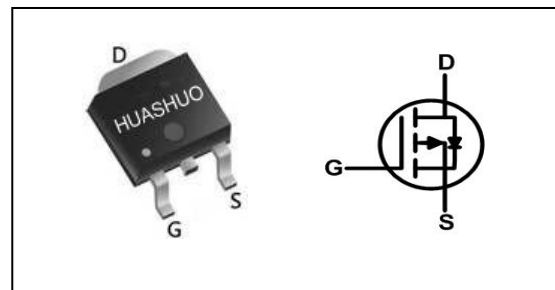

Absolute Maximum Ratings

Symbol	Parameter	Rating	Units
V _{DS}	Drain-Source Voltage	-200	V
V _{GS}	Gate-Source Voltage	± 20	V
I _D @T _C =25°C	Continuous Drain Current, V _{GS} @ -10V ¹	-5	A
I _D @T _C =70°C	Continuous Drain Current, V _{GS} @ -10V ¹	-3	A
I _D @T _A =25°C	Continuous Drain Current, V _{GS} @ -10V ¹	-1.2	A
I _D @T _A =70°C	Continuous Drain Current, V _{GS} @ -10V ¹	-1	A
I _{DM}	Pulsed Drain Current ²	-6.5	A
P _D @T _A =25°C	Total Power Dissipation ³	2	W
T _{STG}	Storage Temperature Range	-55 to 150	°C
T _J	Operating Junction Temperature Range	-55 to 150	°C

Thermal Data

Symbol	Parameter	Typ.	Max.	Unit
R _{θJA}	Thermal Resistance Junction-ambient ¹	---	62	°C/W
R _{θJC}	Thermal Resistance Junction-Case ¹	---	7	°C/W

Electrical Characteristics (T_J=25 °C, unless otherwise noted)

Symbol	Parameter	Conditions	Min.	Typ.	Max.	Unit
BV _{DSS}	Drain-Source Breakdown Voltage	V _{GS} =0V, I _D =-250uA	-200	---	---	V
R _{DS(ON)}	Static Drain-Source On-Resistance ²	V _{GS} =-10V, I _D =-1A	---	1.9	2.4	Ω
V _{GS(th)}	Gate Threshold Voltage	V _{GS} =V _{DS} , I _D =-250uA	-2.0	-3.0	-4.0	V
I _{DSS}	Drain-Source Leakage Current	V _{DS} =-160V, V _{GS} =0V, T _J =25°C	---	---	1	uA
		V _{DS} =-160V, V _{GS} =0V, T _J =55°C	---	---	10	
I _{GSS}	Gate-Source Leakage Current	V _{GS} = ± 20V, V _{DS} =0V	---	---	± 100	nA
g _{fs}	Forward Transconductance	V _{DS} =-5V, I _D =-0.8A	---	0.5	---	S
Q _g	Total Gate Charge	V _{DS} =-100V, V _{GS} =-4.5V, I _D =-0.5A	---	8.5	---	nC
Q _{gs}	Gate-Source Charge		---	1.5	---	
Q _{gd}	Gate-Drain Charge		---	1.8	---	
T _{d(on)}	Turn-On Delay Time	V _{DD} =-100V, V _{GS} =-10V, R _G =6Ω I _D =-0.5A	---	1.9	---	ns
T _r	Rise Time		---	1.2	---	
T _{d(off)}	Turn-Off Delay Time		---	22	---	
T _f	Fall Time		---	11	---	
C _{iss}	Input Capacitance	V _{DS} =-100V, V _{GS} =0V, f=1MHz	---	500	---	pF
C _{oss}	Output Capacitance		---	39	---	
C _{rss}	Reverse Transfer Capacitance		---	20	---	

Diode Characteristics

Symbol	Parameter	Conditions	Min.	Typ.	Max.	Unit
I _S	Continuous Source Current ^{1,4}	V _G =V _D =0V, Force Current	---	---	-5	A
V _{SD}	Diode Forward Voltage ²	V _{GS} =0V, I _S =-1A, T _J =25°C	---	---	-1.3	V

Note :

- 1.The data tested by surface mounted on a 1 inch² FR-4 board with 2OZ copper.
- 2.The data tested by pulsed, pulse width ≤ 300us, duty cycle ≤ 2%
- 3.The power dissipation is limited by 150°C junction temperature
- 4.The data is theoretically the same as I_D and I_{DM}, in real applications, should be limited by total power dissipation.



Typical Characteristics

Figure 1. Output Characteristics

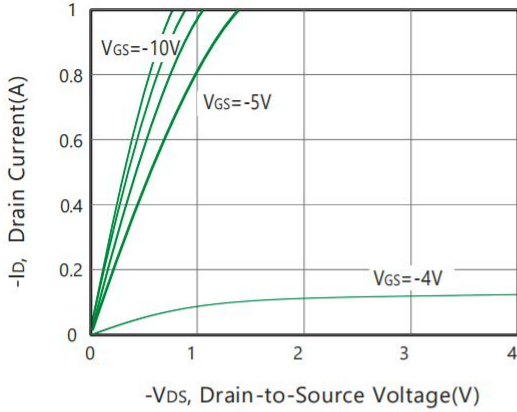

Figure 2. Body Diode Forward Voltage Variation with Source Current

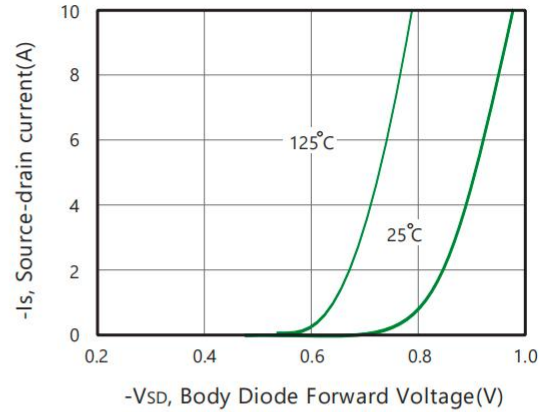

Figure 3. On-Resistance vs. Gate-Source Voltage

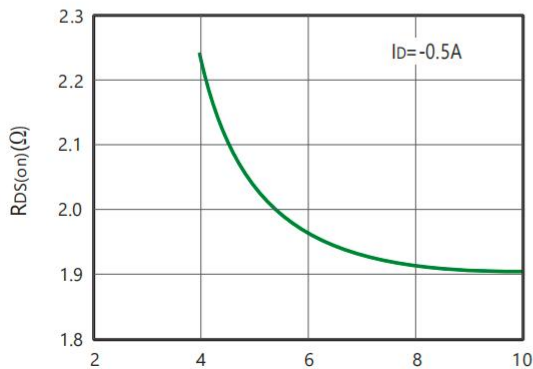

Figure 4. On-Resistance Variation with Drain Current and Temperature

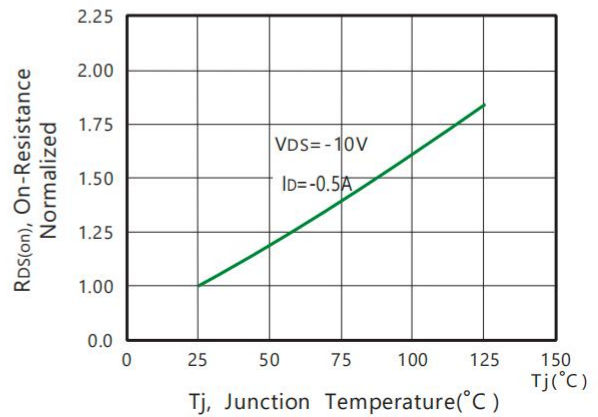

Figure 5. Gate Threshold Variation with Temperature

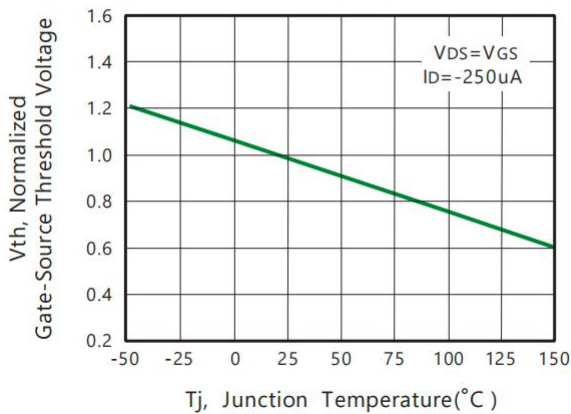

Figure 6. Gate Charge

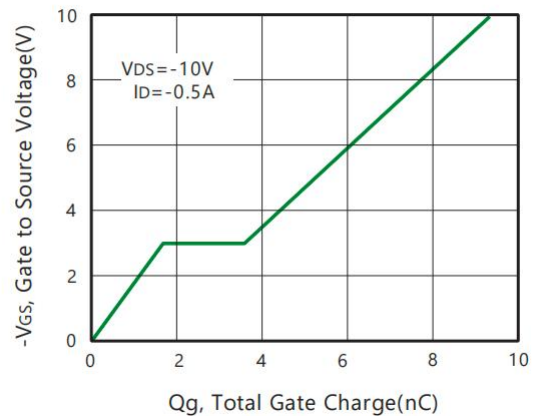



Figure 7. Capacitance

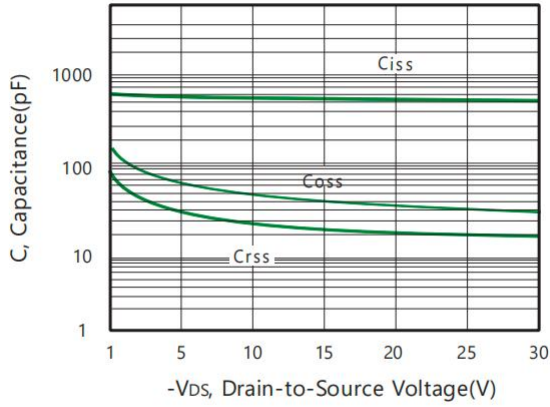

Figure 8. Maximum Safe Operating Area

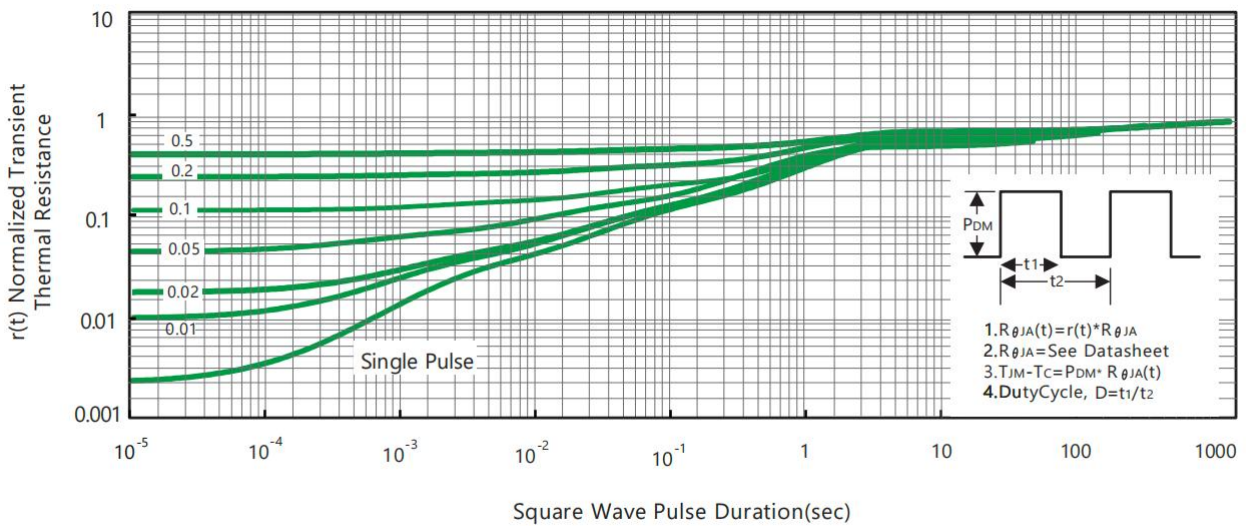
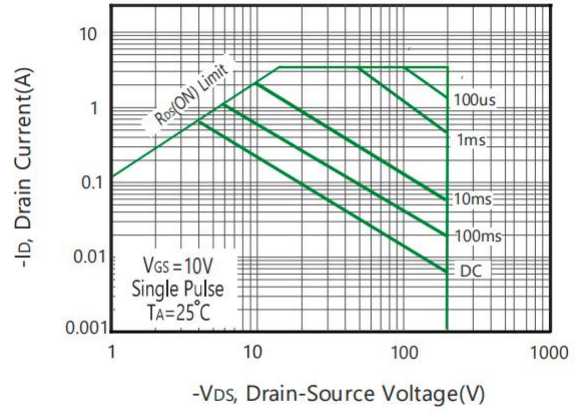
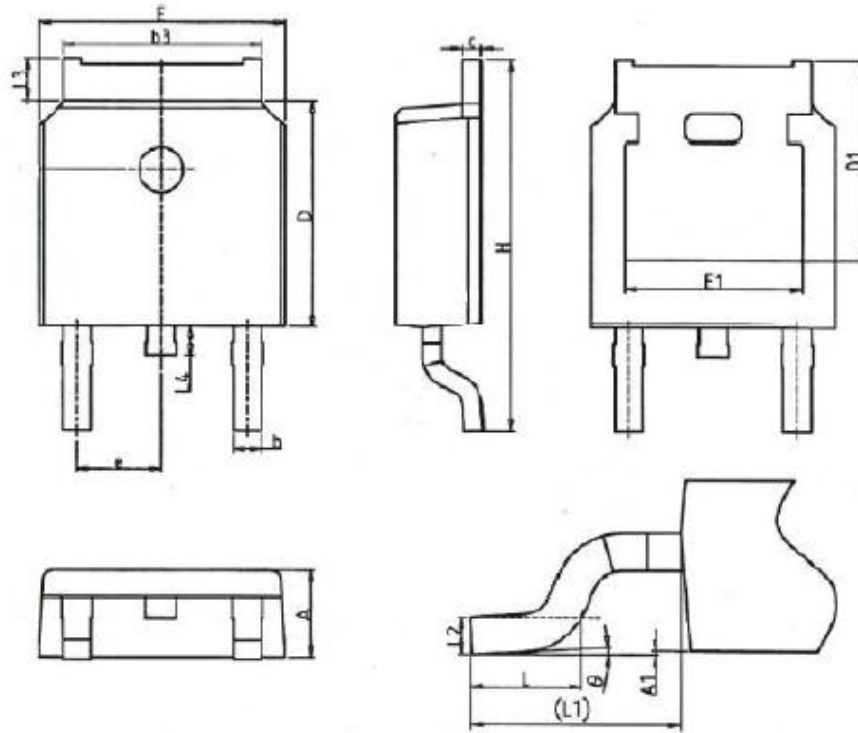

Figure 9. Normalized Thermal Transient Impedance Curve



TO252-2L Package Outline



SYMBOLS	MILLIMETERS		INCHES	
	MIN	MAX	MIN	MAX
A	2.18	2.40	0.086	0.095
A1	-	0.2	-	0.008
b	0.68	0.9	0.026	0.036
b3	4.95	5.46	0.194	0.215
c	0.43	0.89	0.017	0.035
D	5.97	6.22	0.235	0.245
D1	5.300REF		0.209REF	
E	6.35	6.73	0.250	0.265
E1	4.32	--	0.170	-
e	2.286BSC		0.09BSC	
H	9.4	10.5	0.370	0.413
L	1.38	1.78	0.054	0.070
L1	2.90REF		0.114REF	
L2	0.51BSC		0.020BSC	
L3	0.88	1.28	0.034	0.050
L4	0.5	1	0.019	0.039
θ	0°	8°	0°	8°

X-ON Electronics

Largest Supplier of Electrical and Electronic Components

Click to view similar products for [MOSFET](#) category:

Click to view products by [HUASHUO](#) manufacturer:

Other Similar products are found below :

[IRFD120](#) [JANTX2N5237](#) [BUK455-60A/B](#) [MIC4420CM-TR](#) [VN1206L](#) [NDP4060](#) [SI4482DY](#) [IPS70R2K0CEAKMA1](#) [SQD23N06-31L-GE3](#)
[TK16J60W,S1VQ\(O](#) [2SK2614\(TE16L1,Q\)](#) [DMN1017UCP3-7](#) [DMN1053UCP4-7](#) [SQJ469EP-T1-GE3](#) [NTE2384](#) [DMC2700UDMQ-7](#)
[DMN2080UCB4-7](#) [DMN61D9UWQ-13](#) [US6M2GTR](#) [DMN31D5UDJ-7](#) [DMP22D4UFO-7B](#) [DMN1006UCA6-7](#) [DMN16M9UCA6-7](#)
[STF5N65M6](#) [IRF40H233XTMA1](#) [STU5N65M6](#) [DMN6022SSD-13](#) [DMN13M9UCA6-7](#) [DMTH10H4M6SPS-13](#) [DMN2990UFB-7B](#)
[IPB80P04P405ATMA2](#) [2N7002W-G](#) [MCAC30N06Y-TP](#) [MCQ7328-TP](#) [NTMC083NP10M5L](#) [BXP7N65D](#) [BXP4N65F](#) [AOL1454G](#)
[WMJ80N60C4](#) [BXP2N20L](#) [BXP2N65D](#) [BXT1150N10J](#) [BXT1700P06M](#) [TSM60NB380CP](#) [ROG](#) [RQ7L055BGTGR](#) [DMNH15H110SK3-13](#)
[SLF10N65ABV2](#) [BSO203SP](#) [BSO211P](#) [IPA60R230P6](#)