

Description

The HSU8119 is the high cell density trenched P-ch MOSFETs, which provide excellent RDS(ON) and gate charge for most of the synchronous buck converter applications. The HSU8119 meet the RoHS and Green Product requirement, 100% EAS guaranteed with full function reliability approved.

- Super Low Gate Charge
- 100% EAS Guaranteed
- Green Device Available
- Excellent CdV/dt effect decline
- Advanced high cell density Trench technology

Product Summary

V_{DS}	-80	V
$R_{DS(ON),typ}$	13.5	m Ω
I_D	-70	A

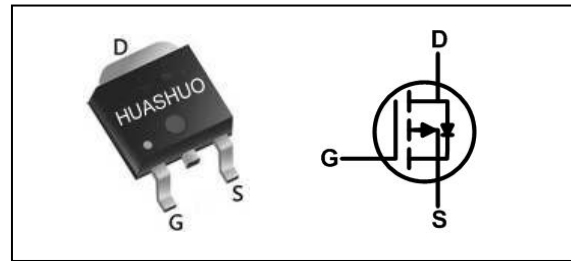
TO-252 Pin Configuration

Absolute Maximum Ratings

Symbol	Parameter	Rating	Units
V_{DS}	Drain-Source Voltage	-80	V
V_{GS}	Gate-Source Voltage	± 20	V
$I_D@T_C=25^\circ\text{C}$	Continuous Drain Current, $-V_{GS} @ -10V^1$	-70	A
$I_D@T_C=100^\circ\text{C}$	Continuous Drain Current, $-V_{GS} @ -10V^1$	-42	A
I_{DM}	Pulsed Drain Current ²	-270	A
EAS	Single Pulse Avalanche Energy ³	710	mJ
I_{AS}	Avalanche Current	63	A
$P_D@T_C=25^\circ\text{C}$	Total Power Dissipation ⁴	130	W
T_{STG}	Storage Temperature Range	-55 to 150	$^\circ\text{C}$
T_J	Operating Junction Temperature Range	-55 to 150	$^\circ\text{C}$

Thermal Data

Symbol	Parameter	Typ.	Max.	Unit
$R_{\theta JA}$	Thermal Resistance Junction-Ambient ¹	---	62	$^\circ\text{C/W}$
$R_{\theta JC}$	Thermal Resistance Junction-Case ¹	---	1.2	$^\circ\text{C/W}$



Electrical Characteristics (T_J=25 °C, unless otherwise noted)

Symbol	Parameter	Conditions	Min.	Typ.	Max.	Unit
BV _{DSS}	Drain-Source Breakdown Voltage	V _{GS} =0V, I _D =-250uA	-80	---	---	V
R _{DS(ON)}	Static Drain-Source On-Resistance ²	V _{GS} =-10V, I _D =-20A	---	13.5	15	mΩ
		V _{GS} =-4.5V, I _D =-10A	---	14.5	17	
V _{GS(th)}	Gate Threshold Voltage	V _{GS} =V _{DS} , I _D =-250uA	-1.0	-1.8	-2.5	V
I _{DSS}	Drain-Source Leakage Current	V _{DS} =-80V, V _{GS} =0V, T _J =25°C	---	---	1	uA
		V _{DS} =-80V, V _{GS} =0V, T _J =55°C	---	---	10	
I _{GSS}	Gate-Source Leakage Current	V _{GS} = ± 20V, V _{DS} =0V	---	---	± 100	nA
R _g	Gate Resistance	V _{GS} =0V, V _{DS} =0V, f=1.0MHz	---	1.7	---	Ω
g _{fs}	Forward Transconductance	V _{DS} =-10V, I _D =-3A	---	30	---	S
Q _g	Total Gate Charge	V _{DS} =-40V, V _{GS} =-10V, I _D =-10A	---	190	---	nC
Q _{gs}	Gate-Source Charge		---	29	---	
Q _{gd}	Gate-Drain Charge		---	55	---	
T _{d(on)}	Turn-On Delay Time	V _{DD} =-40V, V _{GS} =-10V, R _G =6Ω, I _D =-10A	---	25	---	ns
T _r	Rise Time		---	20	---	
T _{d(off)}	Turn-Off Delay Time		---	180	---	
T _f	Fall Time		---	88	---	
C _{iss}	Input Capacitance	V _{DS} =-40V, V _{GS} =0V, f=1MHz	---	13300	---	pF
C _{oss}	Output Capacitance		---	390	---	
C _{rss}	Reverse Transfer Capacitance		---	50	---	

Diode Characteristics

Symbol	Parameter	Conditions	Min.	Typ.	Max.	Unit
I _S	Continuous Source Current ^{1,5}	V _G =V _D =0V, Force Current	---	---	-70	A
I _{SM}	Pulsed Source Current ^{2,5}		---	---	-270	A
V _{SD}	Diode Forward Voltage ²	V _{GS} =0V, I _S =-1A, T _J =25°C	---	---	-1.2	V
T _{rr}	Reverse Recovery Time	I _F =-20A, di/dt=100A/μs	---	35	---	ns
Q _{rr}	Reverse Recovery Charge	I _F =-20A, di/dt=100A/μs	---	45	---	nC

Note :

- 1.The data tested by surface mounted on a 1 inch² FR-4 board with 2OZ copper.
- 2.The data tested by pulsed , pulse width ≤ 300us , duty cycle ≤ 2%
- 3.The EAS data shows Max. rating . The test condition is V_{DD}=-50V,V_{GS}=-10V,L=0.1mH,R_G=25Ω,I_{AS}=-63A
- 4.The power dissipation is limited by 150°C junction temperature
- 5.The data is theoretically the same as I_D and I_{DM} , in real applications , should be limited by total power dissipation.



Typical Characteristics

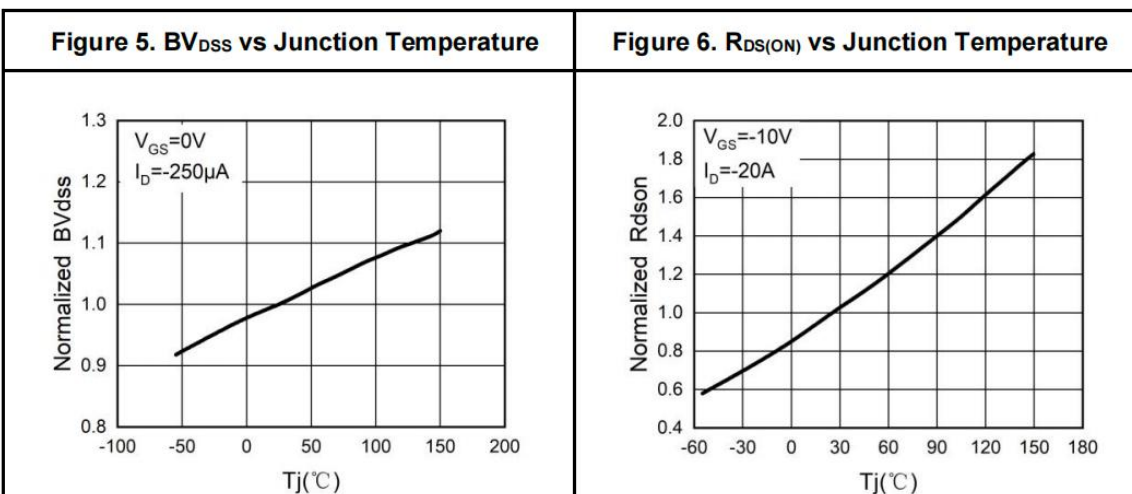
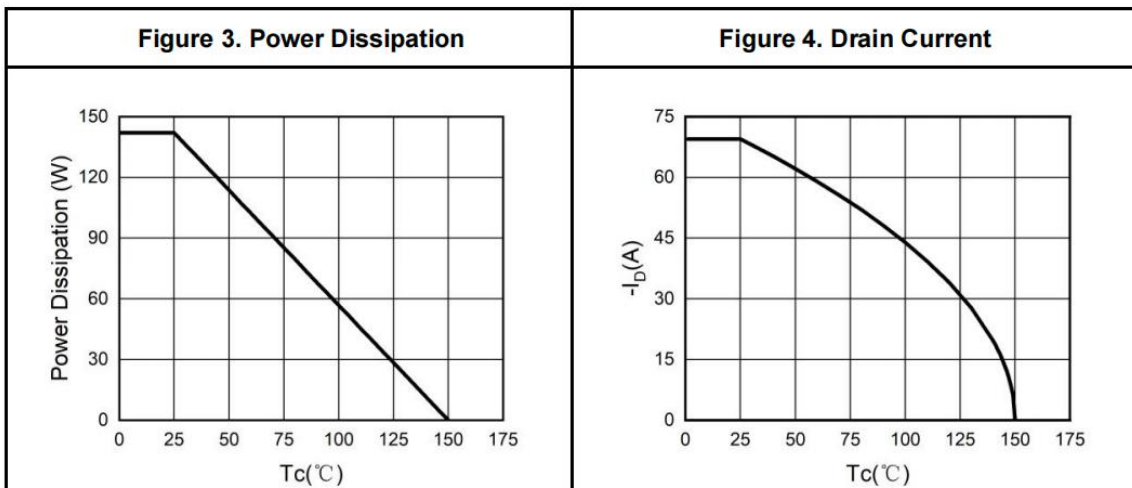
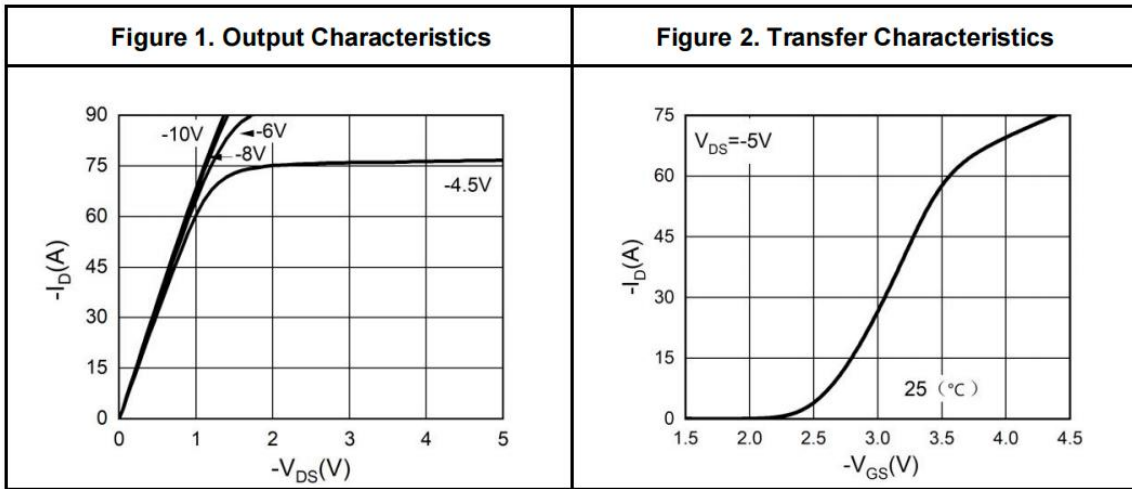

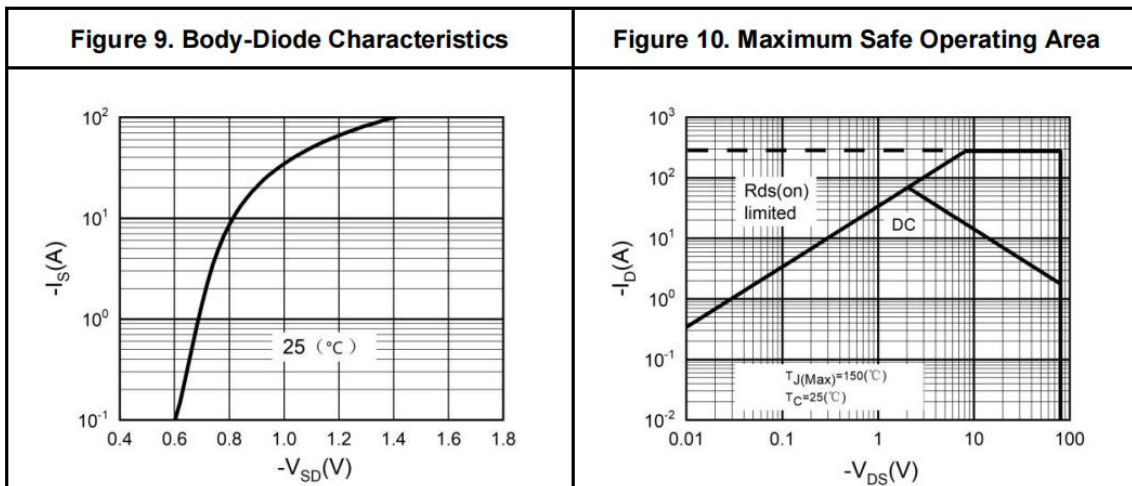
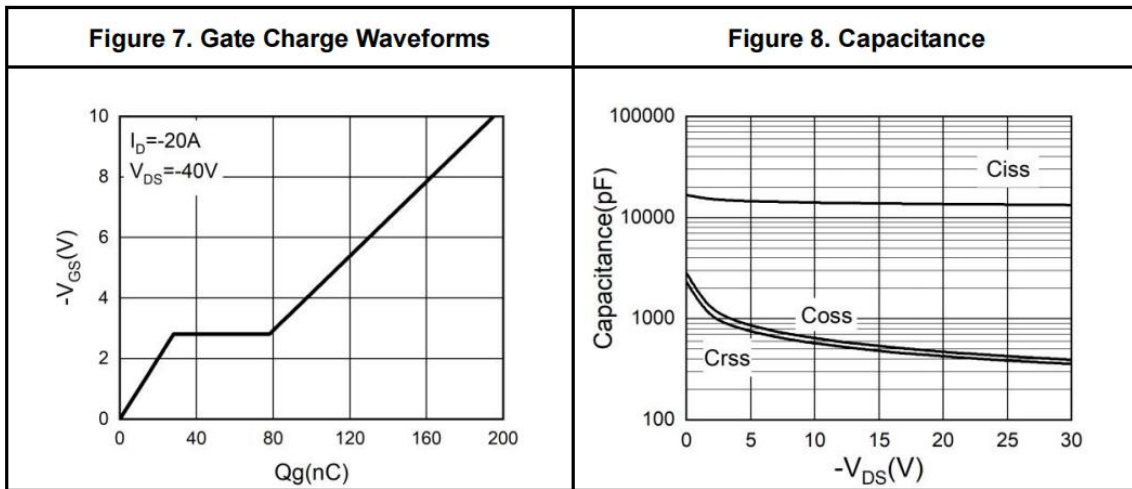



TO252-2L Package Outline

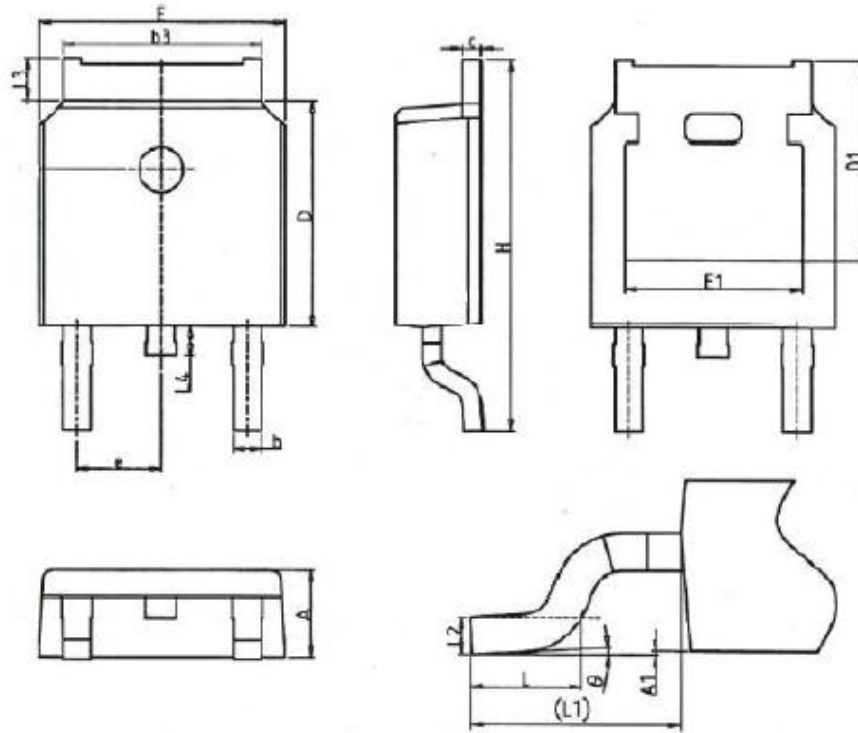

SYMBOLS	MILLIMETERS		INCHES	
	MIN	MAX	MIN	MAX
A	2.18	2.40	0.086	0.095
A1	-	0.2	-	0.008
b	0.68	0.9	0.026	0.036
b3	4.95	5.46	0.194	0.215
c	0.43	0.89	0.017	0.035
D	5.97	6.22	0.235	0.245
D1	5.300REF		0.209REF	
E	6.35	6.73	0.250	0.265
E1	4.32	--	0.170	-
e	2.286BSC		0.09BSC	
H	9.4	10.5	0.370	0.413
L	1.38	1.78	0.054	0.070
L1	2.90REF		0.114REF	
L2	0.51BSC		0.020BSC	
L3	0.88	1.28	0.034	0.050
L4	0.5	1	0.019	0.039
θ	0°	8°	0°	8°

X-ON Electronics

Largest Supplier of Electrical and Electronic Components

Click to view similar products for [MOSFET](#) category:

Click to view products by [HUASHUO](#) manufacturer:

Other Similar products are found below :

[IRFD120](#) [JANTX2N5237](#) [BUK455-60A/B](#) [MIC4420CM-TR](#) [VN1206L](#) [NDP4060](#) [SI4482DY](#) [IPS70R2K0CEAKMA1](#) [SQD23N06-31L-GE3](#)
[TK16J60W,S1VQ\(O](#) [2SK2614\(TE16L1,Q\)](#) [DMN1017UCP3-7](#) [DMN1053UCP4-7](#) [SQJ469EP-T1-GE3](#) [NTE2384](#) [DMC2700UDMQ-7](#)
[DMN2080UCB4-7](#) [DMN61D9UWQ-13](#) [US6M2GTR](#) [DMN31D5UDJ-7](#) [DMP22D4UFO-7B](#) [DMN1006UCA6-7](#) [DMN16M9UCA6-7](#)
[STF5N65M6](#) [IRF40H233XTMA1](#) [STU5N65M6](#) [DMN6022SSD-13](#) [DMN13M9UCA6-7](#) [DMTH10H4M6SPS-13](#) [DMN2990UFB-7B](#)
[IPB80P04P405ATMA2](#) [2N7002W-G](#) [MCAC30N06Y-TP](#) [MCQ7328-TP](#) [NTMC083NP10M5L](#) [NVMFS2D3P04M8LT1G](#) [BXP7N65D](#)
[BXP4N65F](#) [AOL1454G](#) [WMJ80N60C4](#) [BXP2N20L](#) [BXP2N65D](#) [BXT1150N10J](#) [BXT1700P06M](#) [TSM60NB380CP](#) [ROG](#) [RQ7L055BGTCR](#)
[DMNH15H110SK3-13](#) [SLF10N65ABV2](#) [BSO203SP](#) [BSO211P](#)