

N-Ch and P-Ch Fast Switching MOSFETs
Description

The HSW6604 is the high performance complementary N-ch and P-ch MOSFETs with high cell density, which provide excellent RDSON and gate charge for most of the small power switching and load switch applications.

The HSW6604 meet the RoHS and Green Product requirement with full function reliability approved.

- Green Device Available
- Super Low Gate Charge
- Excellent Cdv/dt effect decline
- Advanced high cell density Trench technology

Product Summary

BVDSS	RDSON	ID
20V	38mΩ	4A
-20V	64mΩ	-3A

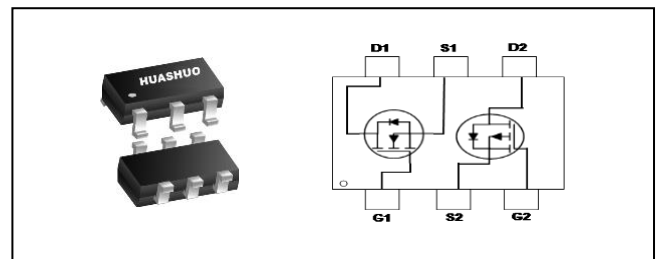
SOT23-6L Pin Configuration

Absolute Maximum Ratings

Symbol	Parameter	Rating		Units
		N-Channel	P-Channel	
		Steady State	Steady State	
V _{DS}	Drain-Source Voltage	20	-20	V
V _{GS}	Gate-Source Voltage	±12	±12	V
I _D @T _A =25°C	Continuous Drain Current, V _{GS} @ -4.5V ¹	4	-3	A
I _D @T _A =70°C	Continuous Drain Current, V _{GS} @ -4.5V ¹	3	-2.6	A
I _{DM}	Pulsed Drain Current ²	16	-12.8	A
P _D @T _A =25°C	Total Power Dissipation ³	1.1	1.1	W
T _{STG}	Storage Temperature Range	-55 to 150	-55 to 150	°C
T _J	Operating Junction Temperature Range	-55 to 150	-55 to 150	°C

Thermal Data

Symbol	Parameter	Typ.	Max.	Unit
R _{θJA}	Thermal Resistance Junction-ambient ¹	---	100	°C/W

N-Ch and P-Ch Fast Switching MOSFETs
N-Channel Electrical Characteristics ($T_J=25\text{ }^\circ\text{C}$, unless otherwise noted)

Symbol	Parameter	Conditions	Min.	Typ.	Max.	Unit
BV_{DSS}	Drain-Source Breakdown Voltage	$V_{GS}=0V, I_D=250\mu A$	20	---	---	V
$R_{DS(ON)}$	Static Drain-Source On-Resistance ²	$V_{GS}=4.5V, I_D=3A$	---	38	48	$m\Omega$
		$V_{GS}=2.5V, I_D=2A$	---	45	55	
$V_{GS(th)}$	Gate Threshold Voltage	$V_{GS}=V_{DS}, I_D=250\mu A$	0.5	0.75	1.2	V
I_{DSS}	Drain-Source Leakage Current	$V_{DS}=16V, V_{GS}=0V, T_J=25^\circ C$	---	---	1	μA
		$V_{DS}=16V, V_{GS}=0V, T_J=55^\circ C$	---	---	5	
I_{GSS}	Gate-Source Leakage Current	$V_{GS}=\pm 12V, V_{DS}=0V$	---	---	± 100	nA
g_{fs}	Forward Transconductance	$V_{DS}=5V, I_D=3A$	---	5	---	S
Q_g	Total Gate Charge (4.5V)	$V_{DS}=10V, V_{GS}=4.5V, I_D=3A$	---	2.7	---	nC
Q_{gs}	Gate-Source Charge		---	0.4	---	
Q_{gd}	Gate-Drain Charge		---	0.5	---	
$T_{d(on)}$	Turn-On Delay Time	$V_{DD}=10V, V_{GS}=4.5V, R_G=3.3\Omega$ $I_D=3A$	---	2.3	---	ns
T_r	Rise Time		---	3.1	---	
$T_{d(off)}$	Turn-Off Delay Time		---	21	---	
T_f	Fall Time		---	2.6	---	
C_{iss}	Input Capacitance	$V_{DS}=10V, V_{GS}=0V, f=1MHz$	---	240	---	pF
C_{oss}	Output Capacitance		---	49	---	
C_{rss}	Reverse Transfer Capacitance		---	23	---	

Diode Characteristics

Symbol	Parameter	Conditions	Min.	Typ.	Max.	Unit
I_S	Continuous Source Current ^{1,4}	$V_G=V_D=0V$, Force Current	---	---	1.8	A
V_{SD}	Diode Forward Voltage ²	$V_{GS}=0V, I_S=1A, T_J=25^\circ C$	---	---	1.2	V

Note :

- 1.The data tested by surface mounted on a 1 inch² FR-4 board with 2OZ copper.
- 2.The data tested by pulsed , pulse width $\leq 300\mu s$, duty cycle $\leq 2\%$
- 3.The power dissipation is limited by 150 $^\circ C$ junction temperature
- 4.The data is theoretically the same as I_D and I_{DM} , in real applications , should be limited by total power dissipation.

N-Ch and P-Ch Fast Switching MOSFETs

N-Channel Typical Characteristics

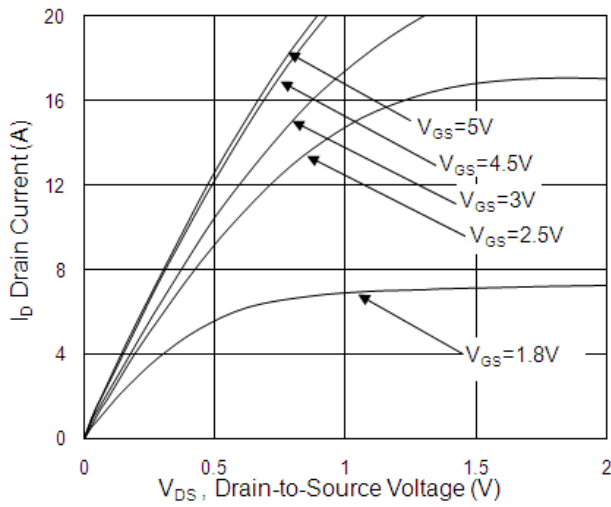

Fig.1 Typical Output Characteristics

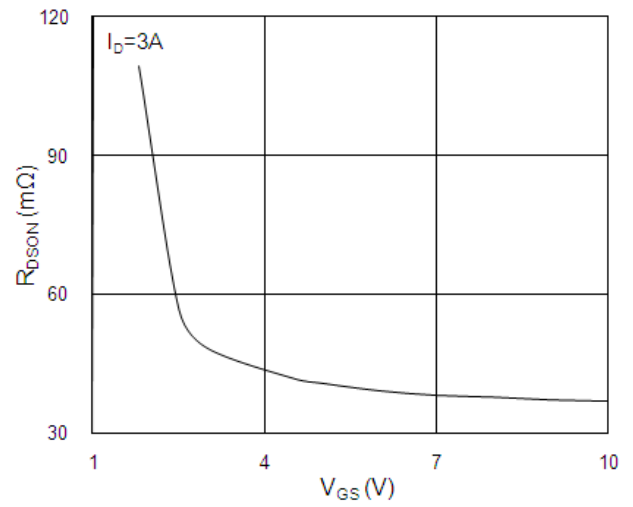

Fig.2 On-Resistance vs G-S Voltage

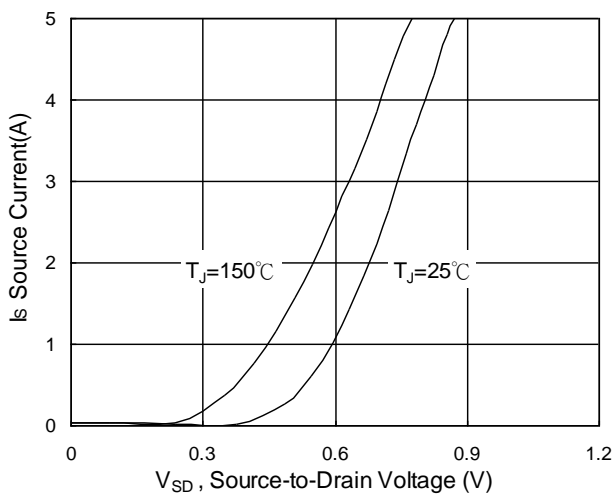

Fig.3 Source Drain Forward Characteristics

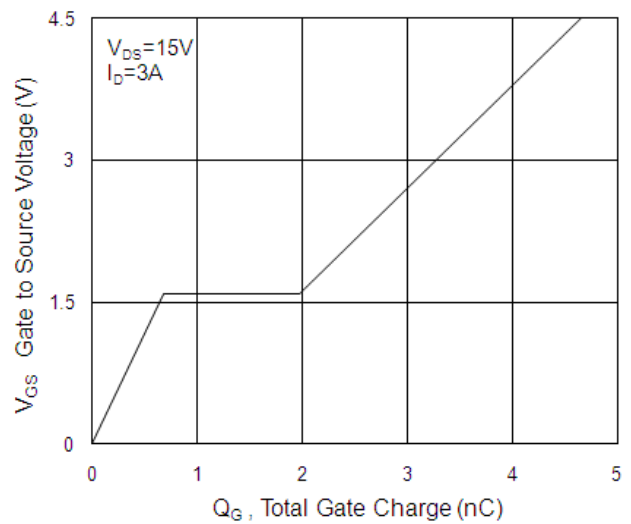

Fig.4 Gate-Charge Characteristics

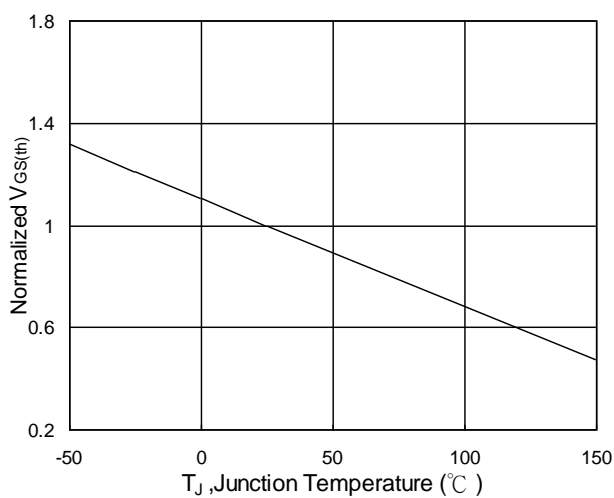

Fig.5 Normalized $V_{GS(th)}$ vs T_J

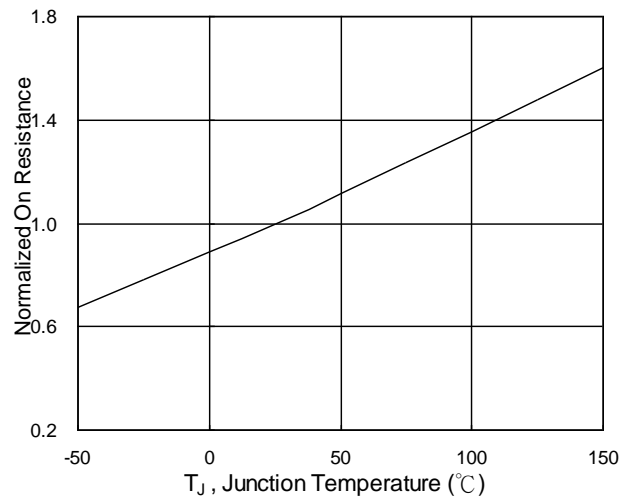

Fig.6 Normalized $R_{DS(on)}$ vs T_J

N-Ch and P-Ch Fast Switching MOSFETs

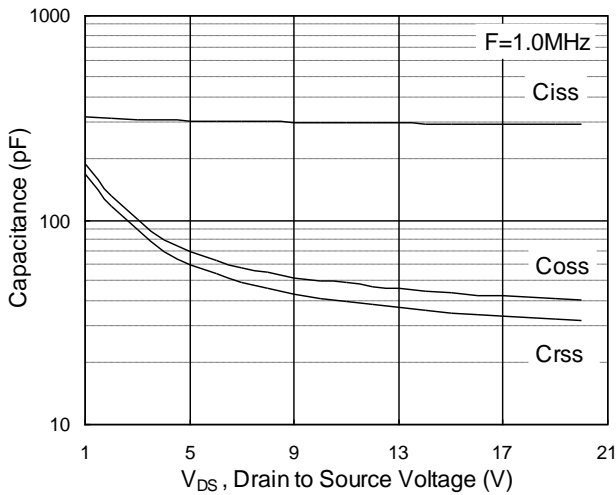

Fig.7 Capacitance

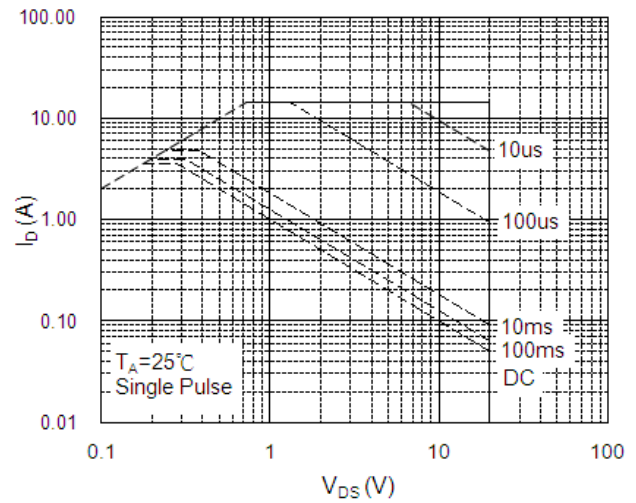

Fig.8 Safe Operating Area

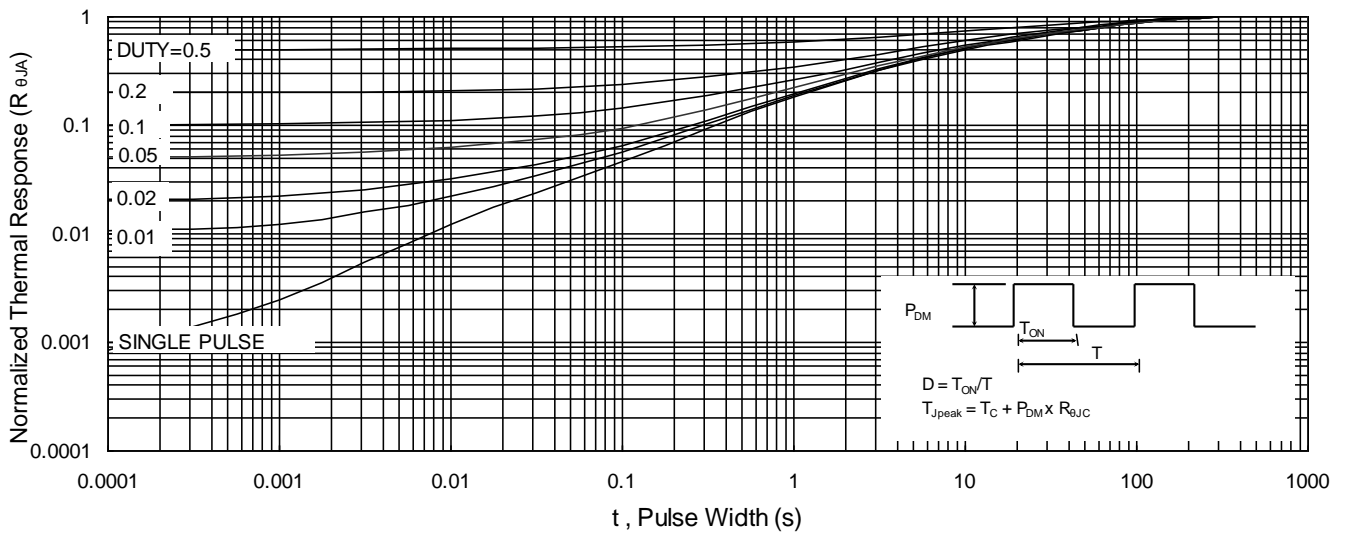

Fig.9 Normalized Maximum Transient Thermal Impedance

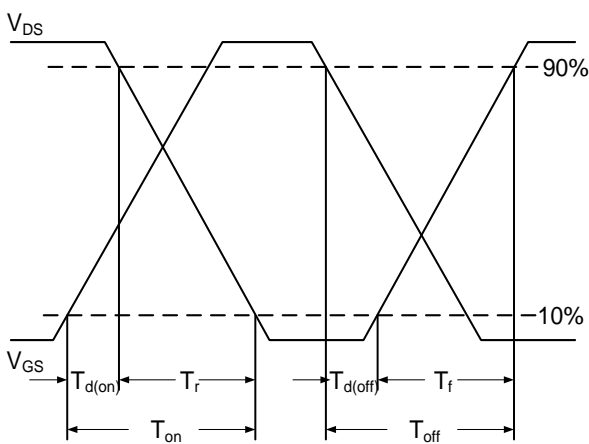

Fig.10 Switching Time Waveform

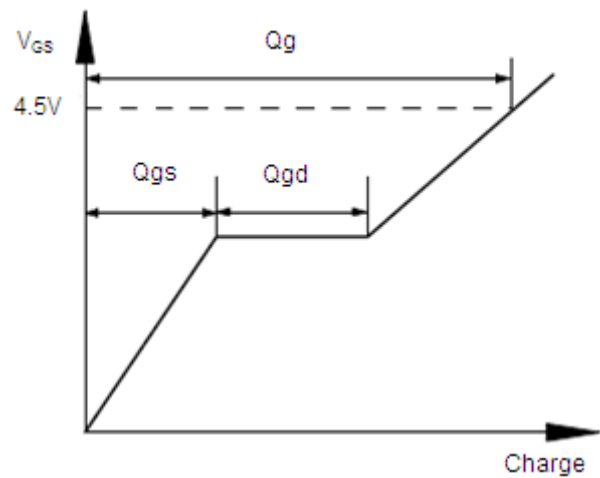

Fig.11 Gate Charge Waveform

N-Ch and P-Ch Fast Switching MOSFETs
P-Channel Electrical Characteristics (T_J=25 °C, unless otherwise noted)

Symbol	Parameter	Conditions	Min.	Typ.	Max.	Unit
B _V DSS	Drain-Source Breakdown Voltage	V _{GS} =0V, I _D =-250uA	-20	---	---	V
R _{DS(ON)}	Static Drain-Source On-Resistance ²	V _{GS} =-4.5V, I _D =-3A	---	64	80	mΩ
		V _{GS} =-2.5V, I _D =-2A	---	82	120	
V _{GS(th)}	Gate Threshold Voltage	V _{GS} =V _{DS} , I _D =-250uA	-0.4	-0.65	-1.2	V
I _{DSS}	Drain-Source Leakage Current	V _{DS} =-16V, V _{GS} =0V, T _J =25°C	---	---	-1	uA
		V _{DS} =-16V, V _{GS} =0V, T _J =55°C	---	---	-5	
I _{GSS}	Gate-Source Leakage Current	V _{GS} =±12V, V _{DS} =0V	---	---	±100	nA
g _{fs}	Forward Transconductance	V _{DS} =-5V, I _D =-3A	---	5	---	S
Q _g	Total Gate Charge (-4.5V)	V _{DS} =-10V, V _{GS} =-4.5V, I _D =-3A	---	6.1	---	nC
Q _{gs}	Gate-Source Charge		---	1.7	---	
Q _{gd}	Gate-Drain Charge		---	1.2	---	
T _{d(on)}	Turn-On Delay Time	V _{DD} =-10V, V _{GS} =-4.5V, R _G =3.3Ω I _D =-3A	---	12	---	ns
T _r	Rise Time		---	6.6	---	
T _{d(off)}	Turn-Off Delay Time		---	113	---	
T _f	Fall Time		---	46	---	
C _{iss}	Input Capacitance	V _{DS} =-10V, V _{GS} =0V, f=1MHz	---	561	---	pF
C _{oss}	Output Capacitance		---	61	---	
C _{rss}	Reverse Transfer Capacitance		---	52	---	

Diode Characteristics

Symbol	Parameter	Conditions	Min.	Typ.	Max.	Unit
I _s	Continuous Source Current ^{1,4}	V _G =V _D =0V, Force Current	---	---	-1.8	A
V _{SD}	Diode Forward Voltage ²	V _{GS} =0V, I _S =-1A, T _J =25°C	---	-0.81	-1.2	V

Note :

- 1.The data tested by surface mounted on a 1 inch² FR-4 board with 2OZ copper.
- 2.The data tested by pulsed , pulse width ≤ 300us , duty cycle ≤ 2%
- 3.The power dissipation is limited by 150°C junction temperature
- 4.The data is theoretically the same as I_D and I_{DM} , in real applications , should be limited by total power dissipation.

N-Ch and P-Ch Fast Switching MOSFETs

Typical Characteristics

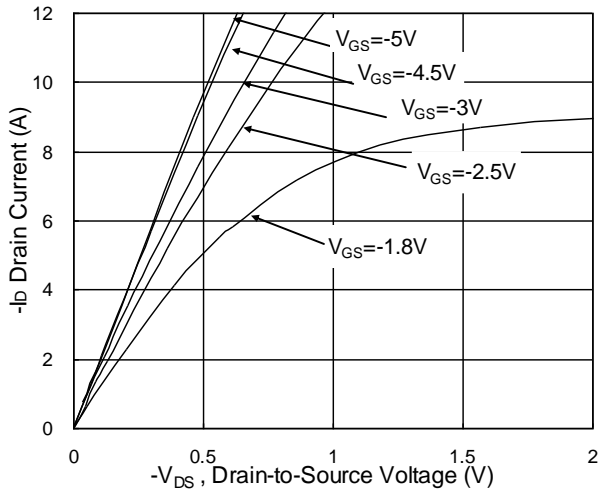

Fig.1 Typical Output Characteristics

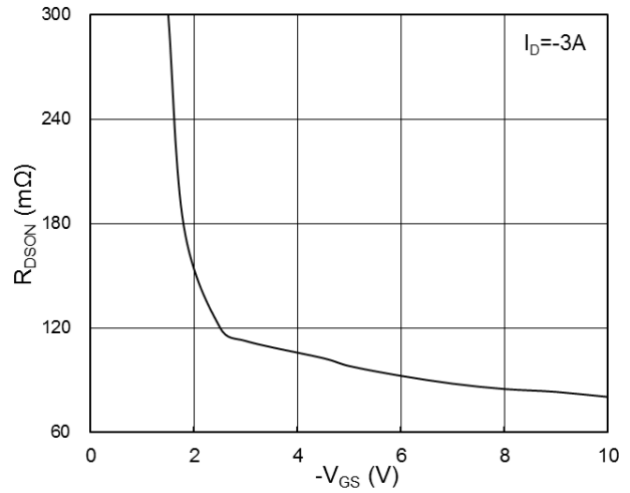

Fig.2 On-Resistance vs G-S Voltage

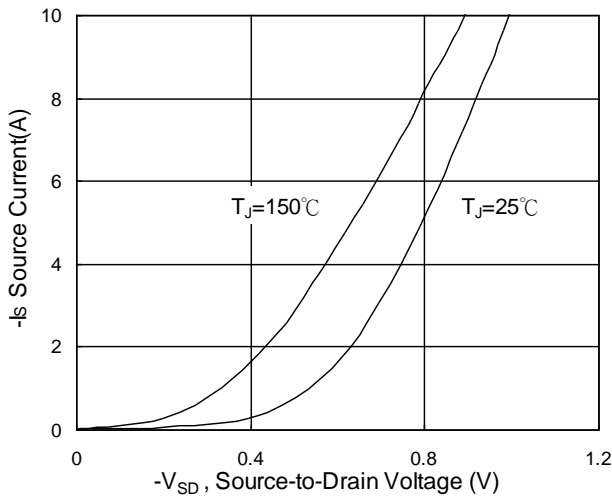

Fig.3 Source Drain Forward Characteristics

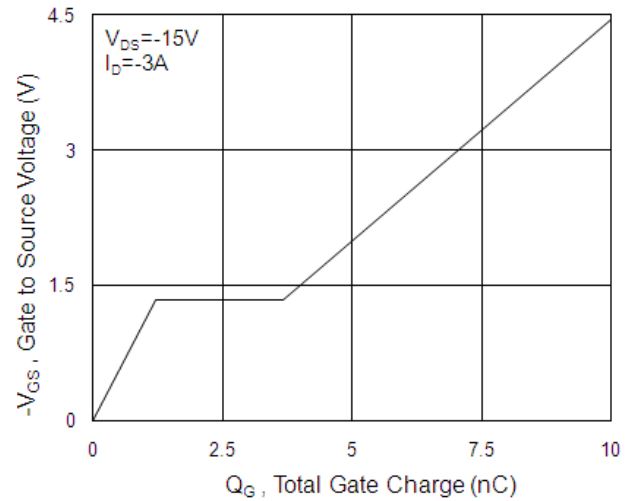

Fig.4 Gate-Charge Characteristics

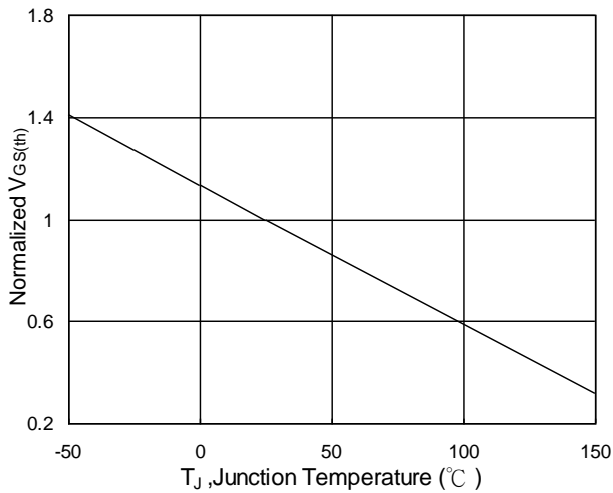

Fig.5 Normalized $V_{GS(th)}$ vs T_J

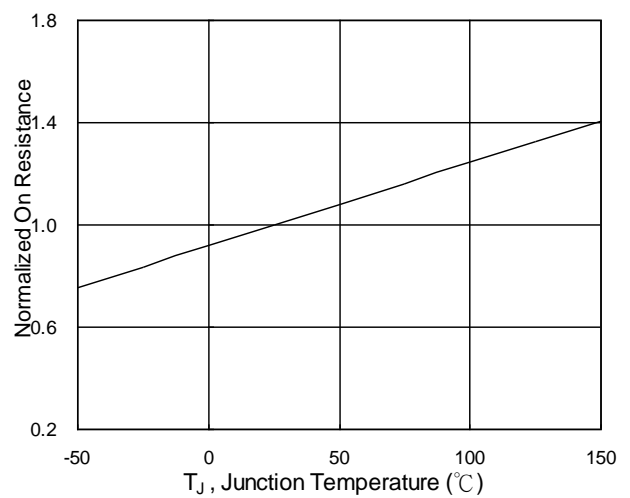

Fig.6 Normalized $R_{DS(on)}$ vs T_J

N-Ch and P-Ch Fast Switching MOSFETs

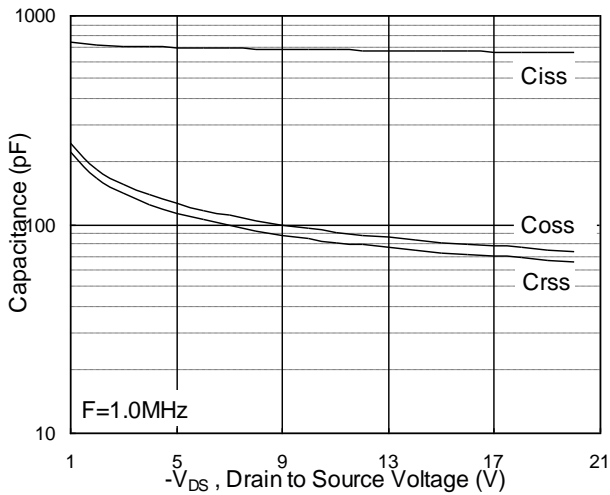

Fig.7 Capacitance

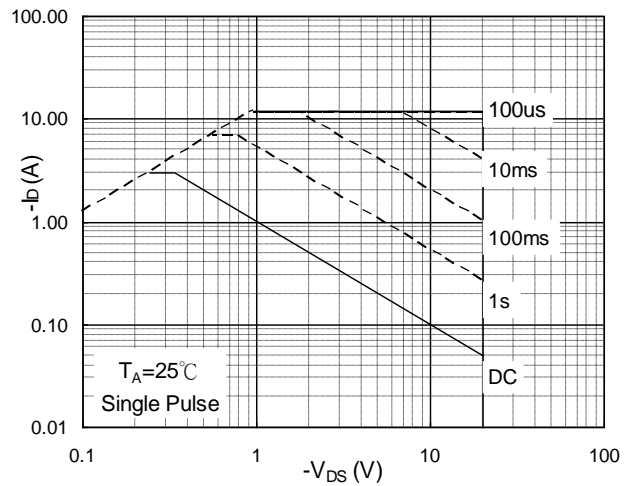

Fig.8 Safe Operating Area

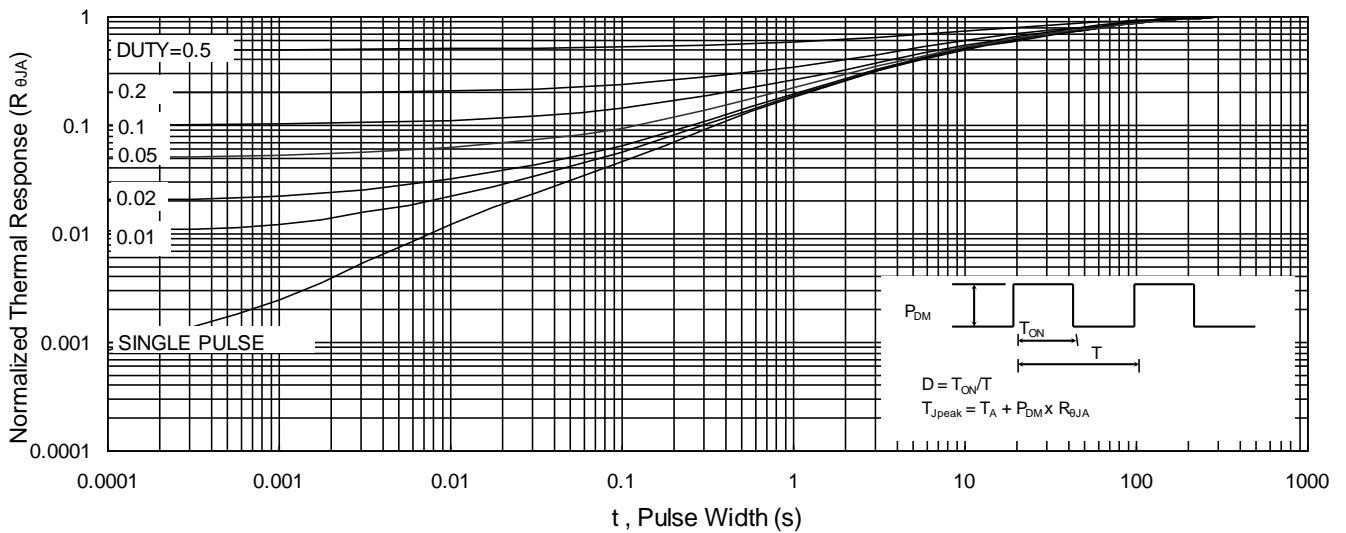

Fig.9 Normalized Maximum Transient Thermal Impedance

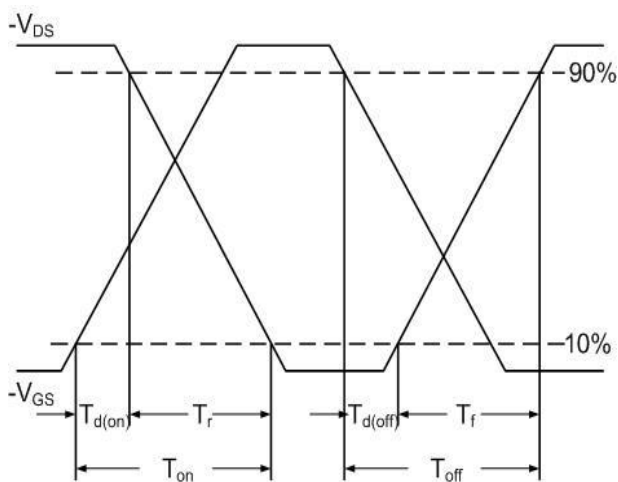

Fig.10 Switching Time Waveform

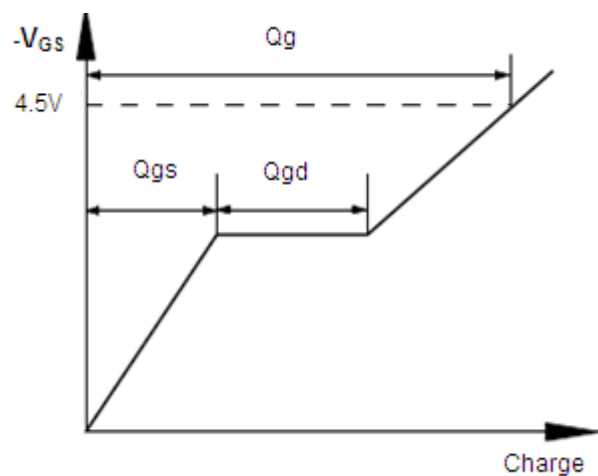
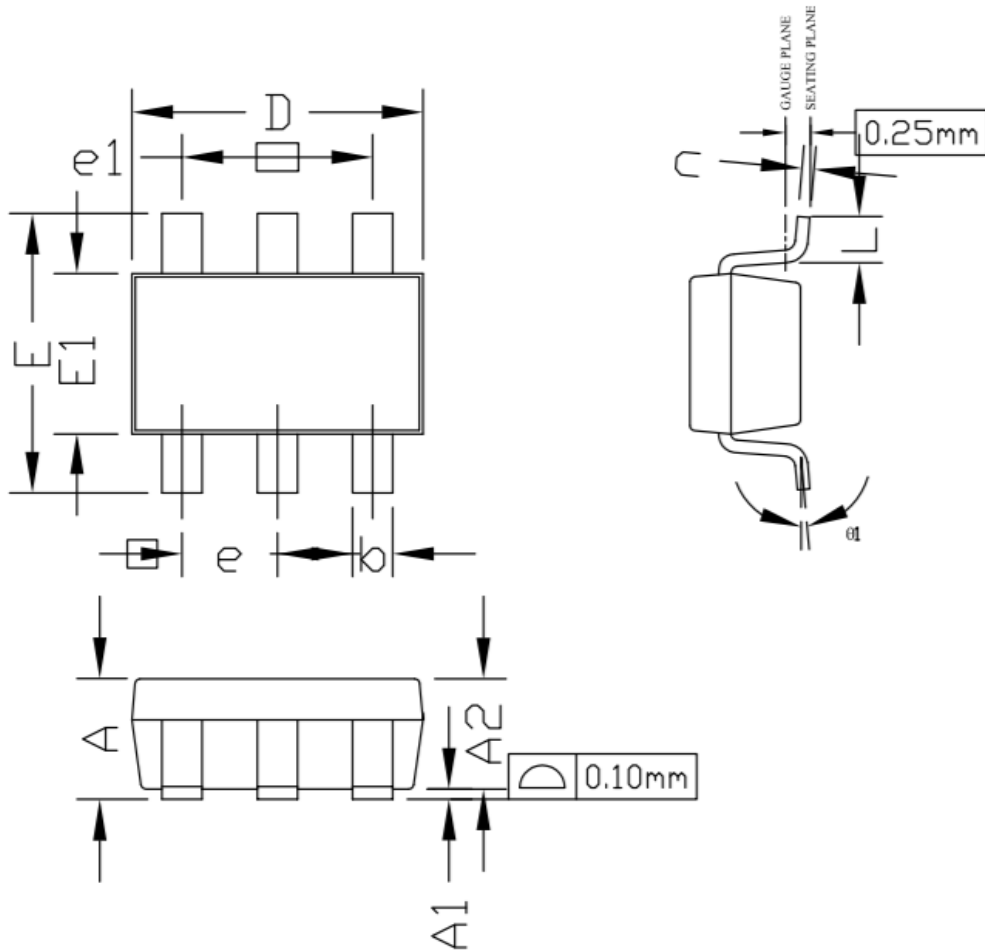
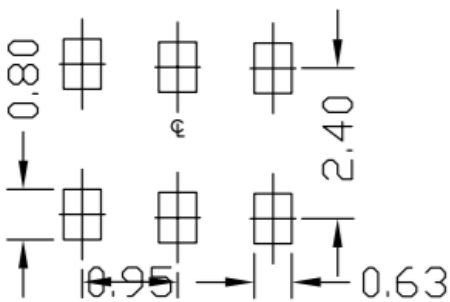

Fig.11 Gate Charge Waveform

SOT23-6 Package Outline Dimensions

RECOMMENDED LAND PATTERN

UNIT: mm

SYMBOLS	DIMENSIONS IN MILLIMETERS			DIMENSIONS IN INCHES		
	MIN	NOM	MAX	MIN	NOM	MAX
A	0.80	—	1.25	0.031	—	0.049
A1	0.00	—	0.15	0.000	—	0.006
A2	0.70	1.10	1.20	0.028	0.043	0.047
b	0.30	0.40	0.50	0.012	0.016	0.020
c	0.08	0.13	0.20	0.003	0.005	0.008
D	2.70	2.90	3.10	0.106	0.114	0.122
E	2.50	2.80	3.10	0.098	0.110	0.122
E1	1.50	1.60	1.70	0.059	0.063	0.067
e	0.95 BSC.			0.037BSC.		
e1	1.90 BSC.			0.075 BSC.		
L	0.30	—	0.60	0.012	—	0.024
θ1	0°	—	8°	0°	—	8°

X-ON Electronics

Largest Supplier of Electrical and Electronic Components

Click to view similar products for [MOSFET](#) category:

Click to view products by [HUASHUO](#) manufacturer:

Other Similar products are found below :

[614233C](#) [648584F](#) [NTNS3A92PZT5G](#) [IRFD120](#) [IRFF430](#) [JANTX2N5237](#) [2N7000](#) [2SK2464-TL-E](#) [FCA20N60_F109](#) [FDZ595PZ](#) [AOD464](#)
[2SK2267\(Q\)](#) [2SK2545\(Q,T\)](#) [405094E](#) [423220D](#) [MIC4420CM-TR](#) [VN1206L](#) [614234A](#) [715780A](#) [SSM6J414TU,LF\(T](#) [751625C](#)
[IPP60R600P6XKSA1](#) [RJK60S5DPK-M0#T0](#) [BSC884N03MS G](#) [BSF024N03LT3 G](#) [PSMN4R2-30MLD](#) [TK31J60W5,S1VQ\(O](#)
[2SK2614\(Te16L1,Q\)](#) [DMN1017UCP3-7](#) [EFC2J004NUZTDG](#) [FCAB21350L1](#) [P85W28HP2F-7071](#) [DMN1053UCP4-7](#) [NTE2384](#) [NTE2969](#)
[NTE6400A](#) [DMN2080UCB4-7](#) [DMN61D9UWQ-13](#) [US6M2GTR](#) [DMN31D5UDJ-7](#) [SSM6P54TU,LF](#) [DMP22D4UFO-7B](#)
[IPS60R3K4CEAKMA1](#) [DMN1006UCA6-7](#) [DMN16M9UCA6-7](#) [STF5N65M6](#) [STU5N65M6](#) [C3M0021120D](#) [DMN13M9UCA6-7](#)
[BSS340NWH6327XTSA1](#)