

STANDARD SPECIFICATION

产品规格书

客户 Customer : _____

客户料号 Customer P/N NO. : _____

产品描述 Product Description : 49S-2P 22.1184MHZ 20PF ±20PPM

HX 料号 P/N. NO. : SP2022M11820001

客户批准 Customer Approval :

审 核	批 准
Checked	APPROVED

(请批准后回签一份 PLEASE RETURN A COPY WITH APPROVAL)

拟 制 DESIGNER	审 核 CHECK	批 准 APPROVED
万力阳	蔡勤	柯建平

地址：深圳市龙华区龙胜路融创智汇大厦C座1401-1402室

Office add: Room 1401-1402, Building C, Rongchuang, Longhua District, shenzhen

TEL: 0755-21044642

FAX: 0551-63350135



REVISION RECORD

NO.	PAGE	REVISE CONTENT	DATE	MODIFIER	AUDITOR
1	1	首次制定	2023. 04. 17	万力阳	蔡勤

Spec Sheet Contents

NO.	Content	Page
1	石英晶体参数规格 QUARTZ CRYSTAL UNIT SPECIFICATION	4
2	外形尺寸 BOUNDARY DIMENSION	5
3	印字内容 MARKING	5
4	内部结构 INSIDE STRUCTURE	6
5	包装 PACKING	6
6	回流焊温度曲线 REFLOW PROFILES	7
7	可靠性试验 RELIABILITY SPECIFICATIOND	8
8	可靠性判定 RELIABILITY DETERMINATION	9

1. 石英晶体参数规格 QUARTZ CRYSTAL UNIT SPECIFICATION

※描述 Description : Quartz Crystal
 ※产品型别 Product Type : HC-49S
 ※测量设备 Measure equipment : S&A 250B
 ※电气特性 Electrical Characteristics

	项目 Item	符号 Symbol	电气特性规格 Electrical Specification				备注 Notes
			下限 Min.	中心 Typ.	上限 Max.	单位 Units	
1	标准频率 Nominal Frequency	F0	22.1184			MHz	
2	震荡模式 Oscillation Mode	-	Fundamental			-	AT-CUT
3	负载电容 Load Capacitance	CL	20			pF	
4	频率偏差 Frequency Tolerance	-	-20	-	20	ppm	At 25°C±°C
5	温度频差 Equivalent Series Resistance		-30	-	30	ppm	
6	工作温度 Operating Temperature	TC	-40	-	85	°C	
7	激励功率 Drive Level	DL	1	350	350	μW	
8	谐振电阻 Resonant resistance	RR		≤70		Ω	
9	静电容 Direct capacitance	C0		≤3.0		pF	
10	绝缘电阻 Insulation resistance	IR		≥500		MΩ	At DC 100V
11	寄生衰减 Parasitic attenuation	SPDB		≤-3		dB	-1000ppm~6500ppm
12	老化率 Aging rate			±2		ppm	1st year max
13	储存温度范围 Storage temperature range	-	-55	-	+125	°C	

2. 外形尺寸 BOUNDARY DIMENSION

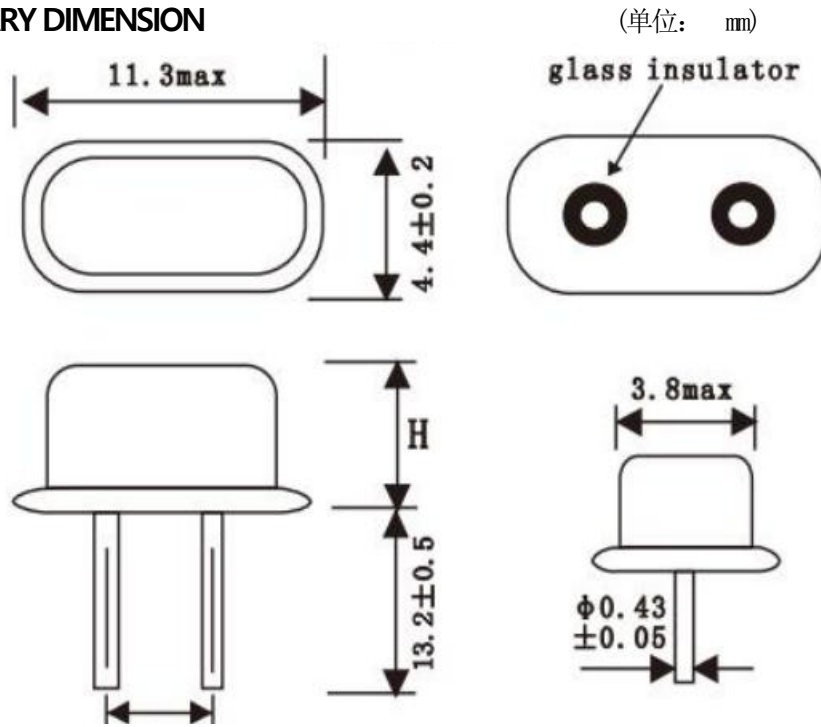

3. 印字

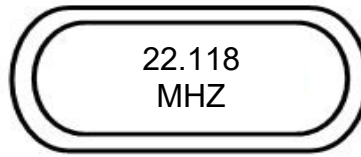

22.118 ----- 标称频率
MHZ ----- 单位

印字说明: 采用年+周的组合方式进行印字, 如 1513, 即表示 2015 年 的第 13 周生产产品; 增加负载电容标识的目的为区分不同负载产品.

4. 内部结构图 INSIDE STRUCTURE

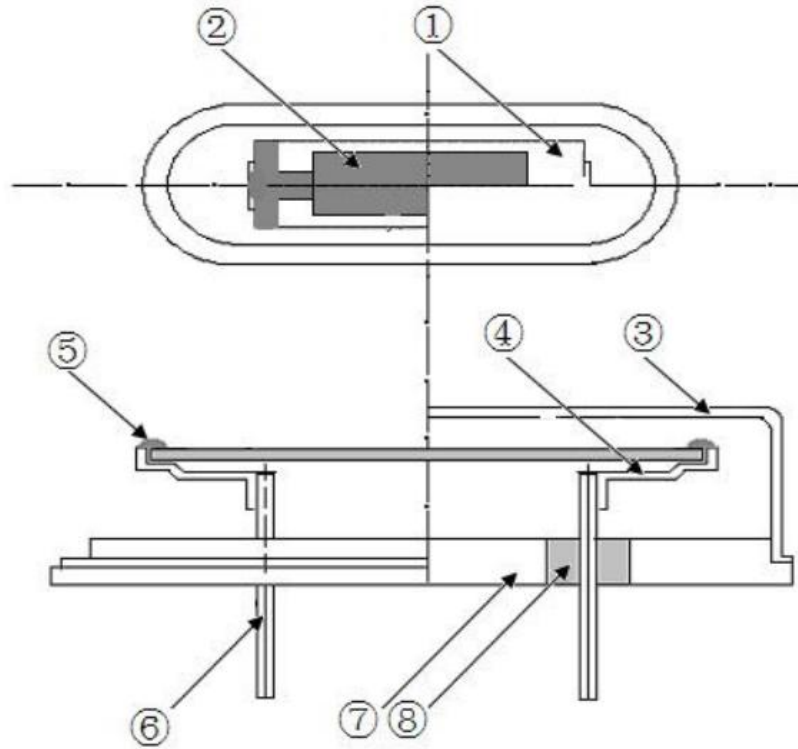

No.	组件 COMPONENTS	材料成份 MATERIALS
1	晶片 Crystal blank	SiO ₂
2	电极 Electrode	Ag
3	外壳 Shell	BZn
4	弹片 Shrapnel	Cu
5	导电胶 Conducting rein	Ag+环氧树脂
6	引线 Lead	Kovar
7	底板 Baseboard	Fe
8	绝缘籽 Insulation seed	SiO ₂

6. 编带包装 BRAID PACKAGING

(单位: mm)

1. 载带与编带盘尺寸

1. 塑料袋包装

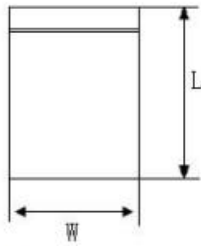

200 pcs / 包

2. 内箱

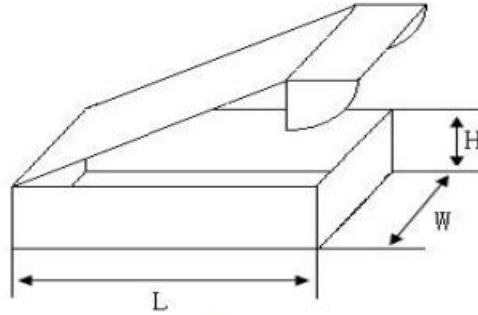

10 包 / 每盒

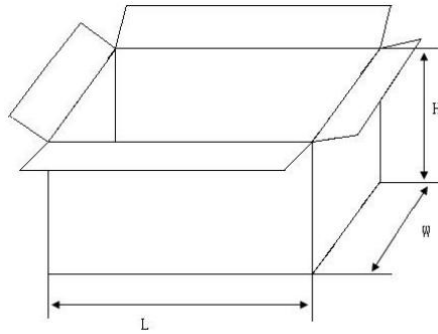

10 盒 / 箱(标准)

4. 尺寸与数量 (单位: mm)

类型	尺寸 (L*W*H)	数量
塑料袋	125*100	200pcs
内箱	190*146*70	2000pcs
纸箱	410*345*252	20000pcs

7. 回流焊温度曲线 REFLOW PROFILES

参考标准 REFER: JEDEC J-STD-020D

Profiles Feature	Pb-Free Assembly
Preheat/Soak Temperature Min (Ts min) Temperature Max (Ts max) Time (Ts) from (Ts min to Ts max)	150°C 200°C 60-120 seconds
Ramp-up rate (TL to TP)	3°C/second max.
Liquidous temperature (TL) Time (TL) maintained above TL	217°C 60-150 seconds
Peak/Classification Temperature (TP)	260±5°C
Time within 5°C of actual Peak Temperature (TP)	20~40 seconds
Ramp-down rate (TP to TL)	6°C/second max.
Time 25 °C to peak temperature	8 minutes max.
Suggest reflow times	3 Times max

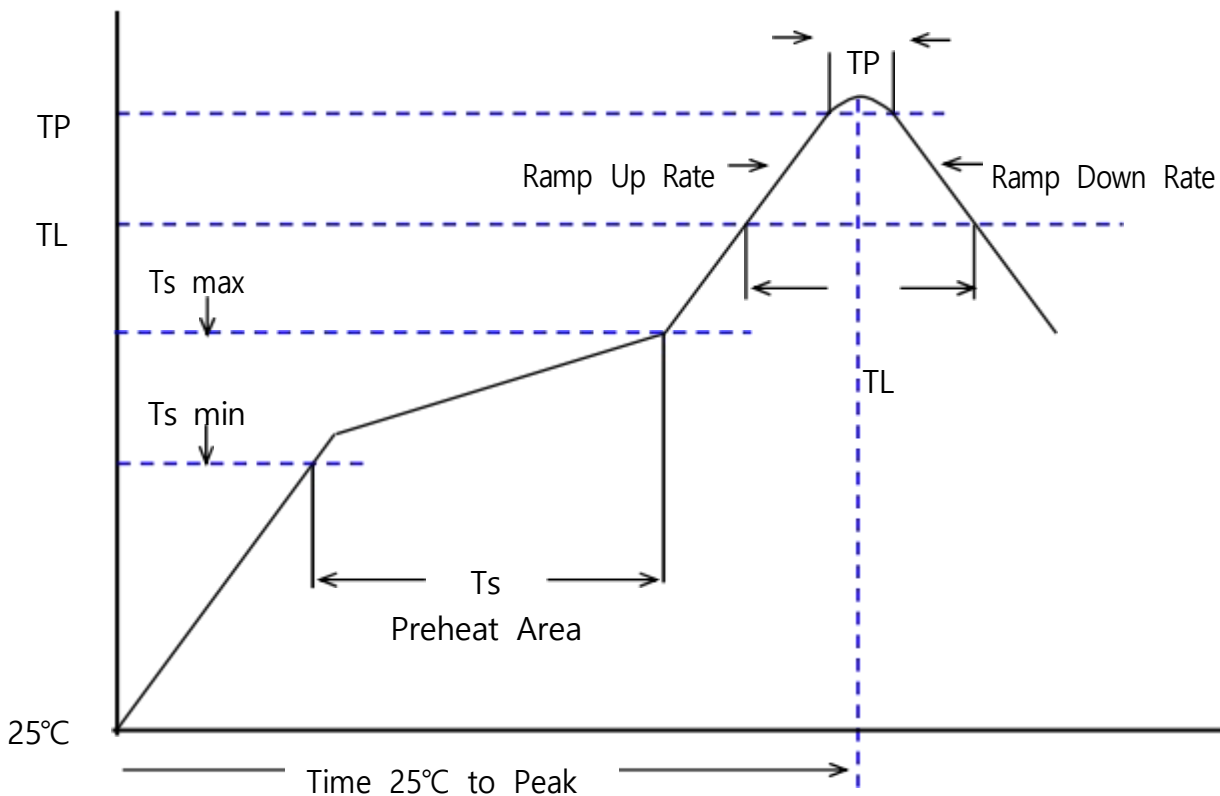

8. 可靠性试验 RELIABILITY SPECIFICATION

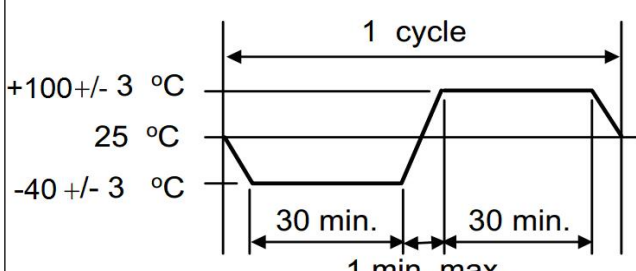
参考标准REFER		JIS C 6701	
NO.	项目 ITEM	测试条件 CONDITIONS	判定标准 Criteria
1	跌落 FREE FALL	从150cm位置高度,自由跌落在木板上,连续3次. FREE DROPPING FROM 150 cm HEIGHT 3 TIMES ON A HARD	A.C
2	振动 VIBRATION	振动频率: 10~2000 Hz, 振幅: 1.52mm, 时间: 每个方位三面(X、Y、Z)各振动2小时 FREQUENCY: 10.2000Hz;AMPLITUDE (TOTAL EXCURSION): 1.5mm SWEEP TIME: 2-3MIN, 3 DIRECTION(X, Y, Z) EACH FOR 2 Hrs.	A.C
3	温度冲击 TEMPERATURE SHOCK	晶体放入试验箱中, 高、低温循环10次 THE CRYSTAL UNIT SHALL BE SUBJECTED TO 10 SUCCESSIVE CHANGE OF TEMPERATURE CYCLE 	A.C.D
4	气密性 FINE LEAK	氦气压力标准: 5.0~5.5Kg/cm ² , 加压时间: 2 小时 HELIUM BOMBING 5.0~5.5 Kgf / cm ² ,FOR 2 HOURS.	D
5	可焊性 SOLDERABILITY	温度: 245±5°C, 浸锡时间: 3±0.5 秒 THE LEAD IS IMMERSIED IN A 245±5°C SOLDER BATH WITHIN 3±0.5 SECONDS.	E
6	稳态湿热 HIGH TEMP. & HUMIDITY	温度: 85 ±3°C, 湿度: 85 %, 保持时间: 500个小时 STORED AT 85 ±3°C AND HUMIDITY 85 % FOR 500±12H.	A.C.D
7	高温存储 HIGH TEMPERATURE STORAGE	高温温度: 125±2°C, 时间: 500±12 个小时 STORED AT 125±2°C FOR 500±12H. 如果客户的温度要求是高于标准,则必须根据客户的要求测试 If Customer's temperature request is higher than the standard, Temperature test must be done for customer requirements	A.C.D
8	低温存储 LOW TEMPERATURE STORAGE	低温温度: -40±2°C, 时间: 500±12 个小时 STORED AT -40±2°C FOR 500±12H. 如果客户的温度要求是低于标准,则必须根据客户的要求测试 If Customer's temperature request is lower than the standard, Temperature test must be done for customer requirements	A.C.D

9. 可靠性判定

规 格	
A	频率变化: $\pm 5\text{ppm}$ 以内或者满足客户规格要求。 Frequency variation: $\pm 5\text{ppm}$ or meet customer specifications.
B	频率变化: $\pm 10\text{ppm}$ 以内或者满足客户规格要求。 Frequency variation: $\pm 10\text{ppm}$ or meet customer specifications.
C	谐振电阻 (RR) 变化: $\pm 20\%$ 以内或者 $5\ \Omega$ 。(取较大值) Resonant resistance (RR) changes: $\pm 20\%$ or less than $5\ \Omega$ (take the larger value).
D	常温常湿状态下放置2小时后测试。规格要求。 Frequency variation: $\pm 10\text{ppm}$ or meet customer specifications.
E	侵入端至少90%面积覆盖着新的焊接材料。 At least 90% of the immersion end is covered with new welding material.

★ 备注:

1. 以上可靠性项目为我司常规测试项目, 若客户对产品有跌落, 冲击, 碰撞以及涉及到超声 波焊接工艺的需求, 请将贵司的需求反馈给我司, 我司会对该产品的可靠性项目进行更新。 2. 客户端在对晶体加热后, 为了保证频率的准确性, 建议将晶体充分冷却后再进行相关测试。 3. 该产品符合公司环保标准要求。

1. The above reliability items are routine test items of our company. If the customer has requirements on the products including drop, impact, collision and ultrasonic wave welding process, please feedback your requirements to our company, and we will update the reliability items of this product. 2. In order to ensure the accuracy of frequency, it is recommended to fully cool the crystal after heating it on the client. 3. The product meets the company's environmental standards.

X-ON Electronics

Largest Supplier of Electrical and Electronic Components

Click to view similar products for [Crystals](#) category:

Click to view products by [huaxindianzi](#) manufacturer:

Other Similar products are found below :

[CX3225GB25000M0PPSZ1](#) [718-13.2-1](#) [7A-40.000MAAE-T](#) [FL2000085](#) [99-BU](#) [9B-15.360MBBK-B](#) [9C-7.680MBBK-T](#) [H10S-12.000-18-EXT-TR](#) [ABC2-6.000MHZ-D4Z-T](#) [ABLS-20.000MHZ-D2-T](#) [ABS071-32.768KHZ-6-T](#) [R38-32.768-12.5-5PPM-NPB](#) [BTD1062E05A-513](#) [21U15A-21.4MHZ](#) [RTX-781DF1-S-20.950](#) [LFXTAL066198Cutt](#) [9C-14.31818MBBK-T](#) [A-11.000MHZ-27](#) [ABL-27.000MHZ-B4Y-T](#) [ABM11-132-24.000MHZ-T3](#) [ABM3B1-25.000MHZ-D2Y-T](#) [SPT2A-.032768B](#) [SPT2A.032768G](#) [LFXTAL065253Cutt](#) [LFXTAL066431Cutt](#) [XT9S20ANA14M7456](#) [XT9SNLANA16M](#) [7A-24.576MBBK-T](#) [7B-30.000MBBK-T](#) [CX2520DB16000H0HPQCC](#) [MMCC2R32.7680KHZ](#) [6504-202-1501](#) [6526-202-1501](#) [ABLS-12.000MHZ-B2Y-T](#) [7A-10.000MBBK-T](#) [SG636PCE-20.000MC](#) [3404](#) [CM315D32768EZFT](#) [C1E-24.000-7-2020-R](#) [C1E-19.200-12-1530-X-R](#) [C1E-16.000-12-1530-X-R](#) [ABM11-16.000MHZ-9-B1U-T](#) [FL5000014](#) [EUCA18-3.1872M](#) [FX0800015](#) [425F35E027M0000](#) [FP0800018](#) [MS3V-T1R-32.768kHz-7pF-20PPM-TA-QC-Au](#) [VXM7-1C1-16M000](#) [MS3V-T1R-32.768kHz-9pF-20PPM-TA-QC-Au](#)