

STANDARD SPECIFICATION

产品规格书

客户 Customer : _____

客户料号 Customer P/N NO. : _____

产品描述 Product Description : 3225-OSC 12.000MHZ 3.3V ±20PPM

HX 料号 P/N. NO. : YF4012M00033001

客户批准 Customer Approval :

审 核	批 准
Checked	APPROVED

(请批准后回签一份 PLEASE RETURN A COPY WITH APPROVAL)

拟 制 DESIGNER	审 核 CHECK	批 准 APPROVED
万力阳	蔡勤	柯建平

地址：深圳市龙华区龙胜路融创智汇大厦C座1401-1402室

Office add: Room 1401-1402, Building C, Rongchuang, Longhua District, shenzhen

TEL: 0755-21044642

FAX: 0551-63350135



REVISION RECORD

NO.	PAGE	REVISE CONTENT	DATE	MODIFIER	AUDITOR
1	1	首次制定	2023.09.22	万力阳	蔡勤

Spec Sheet Contents

NO.	Content	Page
1	石英晶体参数规格 QUARTZ CRYSTAL UNIT SPECIFICATION	4
2	CMOS负载输出波形 LOAD OUTPUT WAVEFORM	5
3	CMOS负载电路测试 LOAD CIRCUIT TEST	5
4	外形尺寸 BOUNDARY DIMENSION	6
5	印字内容 MARKING	6
6	内部结构 INSIDE STRUCTURE	7
7	包装 PACKING	7
8	回流焊温度曲线 REFLOW PROFILES	8
9	可靠性试验 RELIABILITY SPECIFICATIOND	9
10	包装数量 NUMBER OF PACKAGES	10
11	静电敏感等级 ELECTROSTATIC SENSITIVITY LEVEL	11
		11

1. 石英晶体参数规格 QUARTZ CRYSTAL UNIT SPECIFICATION

※描述 Description : Quartz Crystal

※产品型别 Product Type : OSC-3225

※测量设备 Measure equipment : S&A 280B

※电气特性 Electrical Characteristics

	项目 Item	符号 Symbol	电气特性规格 Electrical Specification				备注 Notes
			下限 Min.	中心 Typ.	上限 Max.	单位 Units	
1	标准频率 Nominal Frequency	F0	12.000			MHz	
2	震荡模式 Oscillation Mode	-	Fundamental			-	
3	频率偏差 Frequency Tolerance	FT	-20	-	20	ppm	At 25°C±°C
4	温度频差 Equivalent Series Resistance	TC	-30	-	30	ppm	
5	工作温度 Operating Temperature		-40	-	85	°C	
6	储存温度范围 Storage temperature range	T_stg	-55	-	125	°C	
7	老化率 Aging rate	F_age		±3		ppm	First year
8	供电电压 For the pressure	Vdd	3.3±10%			V	
9	电流 current	Icc			10.0	mA	
10	输出波形 Output waveform		CMOS				
11	占空比 Duty ratio	TH/T	45	50	55	%	
12	输出负载 The output load	CL		15		pF	
13	三态 Output Enable		0.7Vdd			V	Pin 1 Tri-state
14	三态 Output Disable				0.3Vdd	V	

2. CMOS 负载输出波形 LOAD OUTPUT WAVEFORM

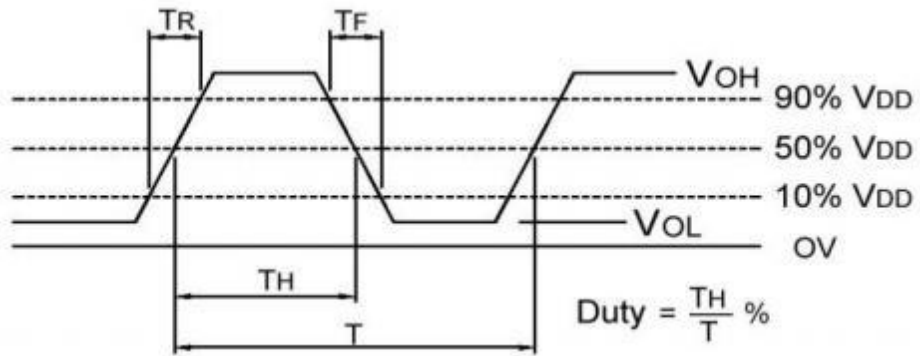

3. CMOS 负载电路测试 LOAD CIRCUIT TEST

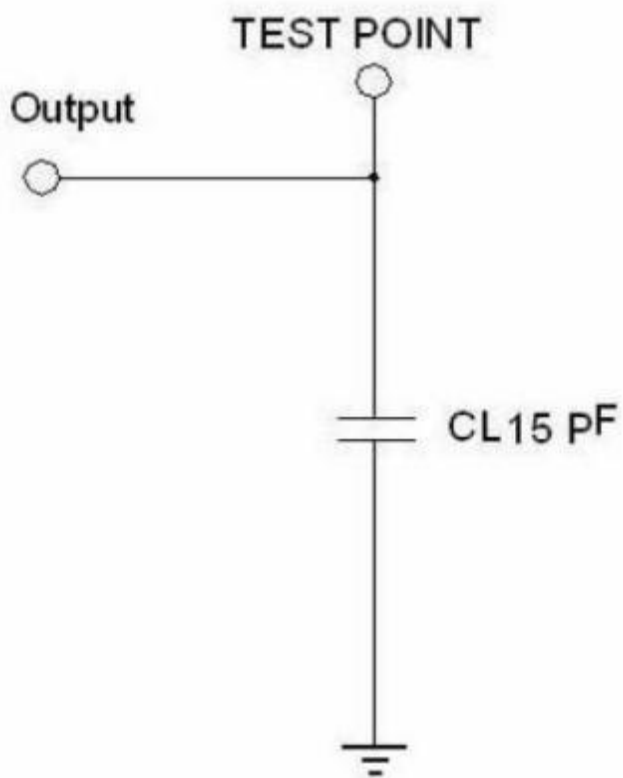

4. 外形尺寸 BOUNDARY DIMENSION

(单位: mm)

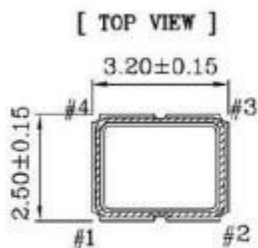

[SIDE VIEW]

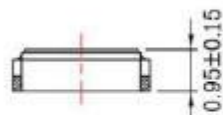

* To ensure optimal oscillator performance, place a by-pass capacitor of 0.1μF as close to the part as possible between VDD and GND pads.

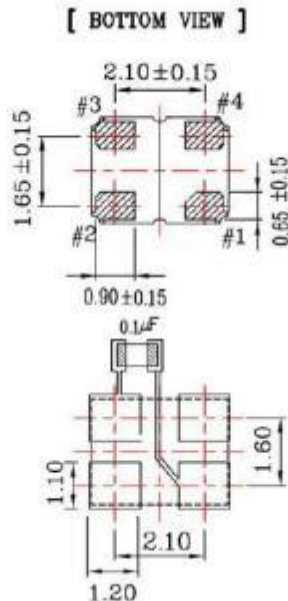

Pin	Function
#1	Tri-State
#2	GND
#3	Output
#4	V _{DD}

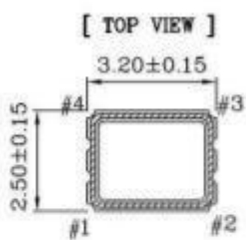

[SIDE VIEW]

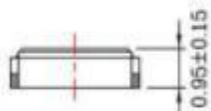

* To ensure optimal oscillator performance, place a by-pass capacitor of 0.1μF as close to the part as possible between VDD and GND pads.

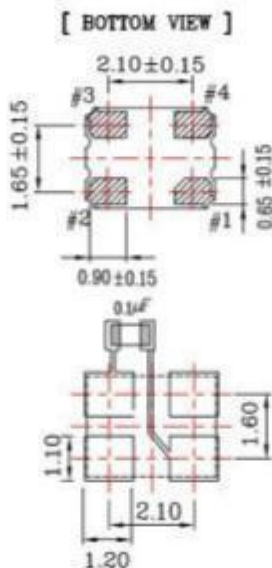

Pin	Function
#1	Tri-State
#2	GND
#3	Output
#4	V _{DD}

5. 印字

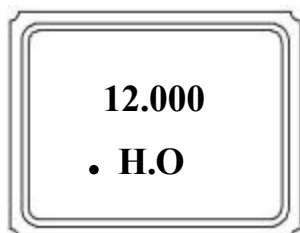

H.0 ----- LOGO
 12.000 ----- 标称频率
 . ----- Pin1

12.000 ----- 标称频率
 MHZ ----- 单位

6. 内部结构图 INSIDE STRUCTURE

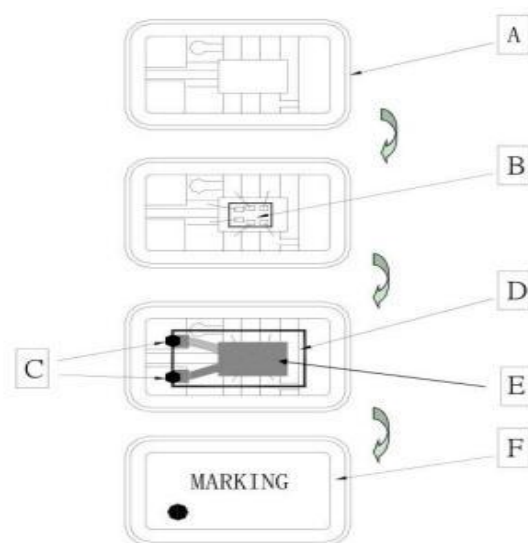

组件及名称		材质	组件及名称		材质
A	基座	Al ₂ O ₃	D	晶片	SiO ₂
B	芯片	硅	E	电极	Cr+Ag
C	导电胶	Ag + 硅树脂	F	上盖	Kovar

7. 编带包装 BRAID PACKAGING

(单位: mm)

1. 载带与编带盘尺寸

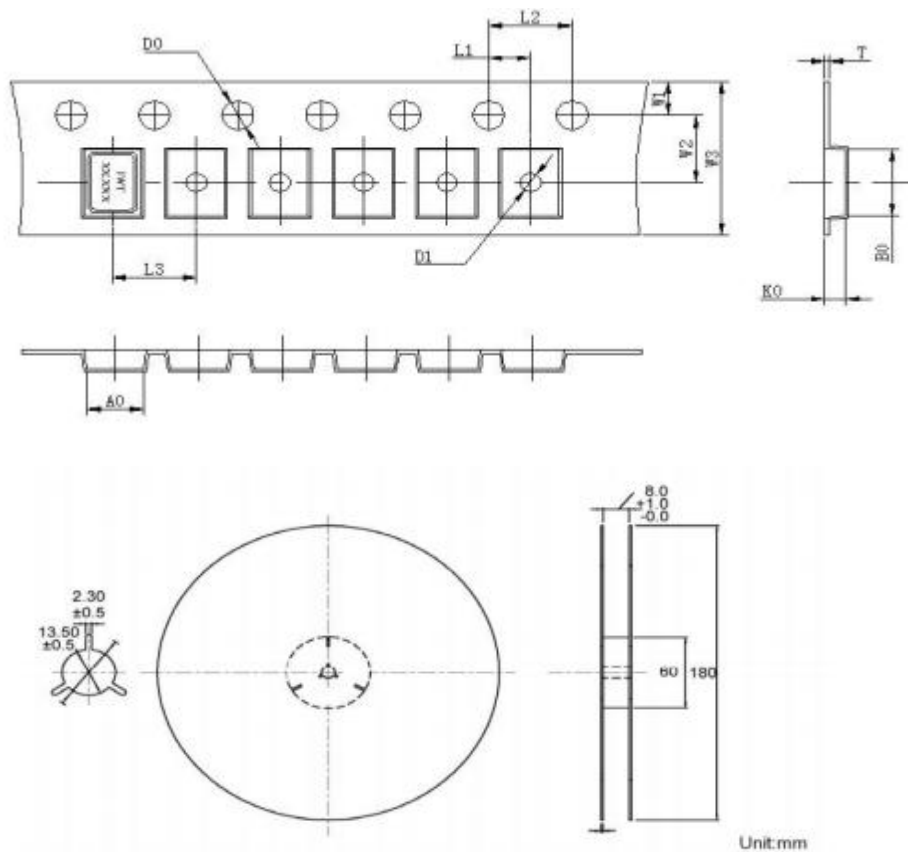

L1	2.00±0.1
L2	4.00±0.1
L3	4.00±0.1
D0	1.50±0.1
D1	1.00±0.1
W0	8.30±0.2
W1	1.75±0.1
W2	3.50±0.1
W3	8.00±0.1
A0	2.72±0.1
B0	3.46±0.1
K0	1.00±0.1
T	0.22±0.05

2. 剥离方式见下图, 强度: 20g-100g

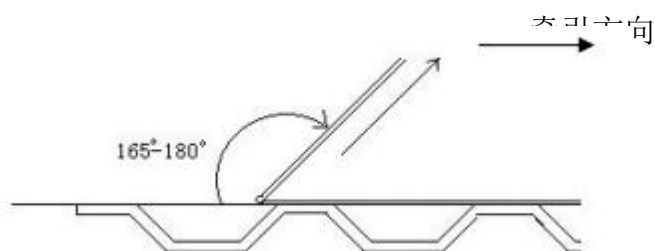

8. 回流焊温度曲线 REFLOW PROFILES

参考标准 REFER: JEDEC J-STD-020D

Profiles Feature	Pb-Free Assembly
Preheat/Soak Temperature Min (Ts min) Temperature Max (Ts max) Time (Ts) from (Ts min to Ts max)	150°C 200°C 60-120 seconds
Ramp-up rate (TL to TP)	3°C/second max.
Liquidous temperature (TL) Time (TL) maintained above TL	217°C 60-150 seconds
Peak/Classification Temperature (TP)	260±5°C
Time within 5°C of actual Peak Temperature (TP)	20~40 seconds
Ramp-down rate (TP to TL)	6°C/second max.
Time 25 °C to peak temperature	8 minutes max.
Suggest reflow times	3 Times max

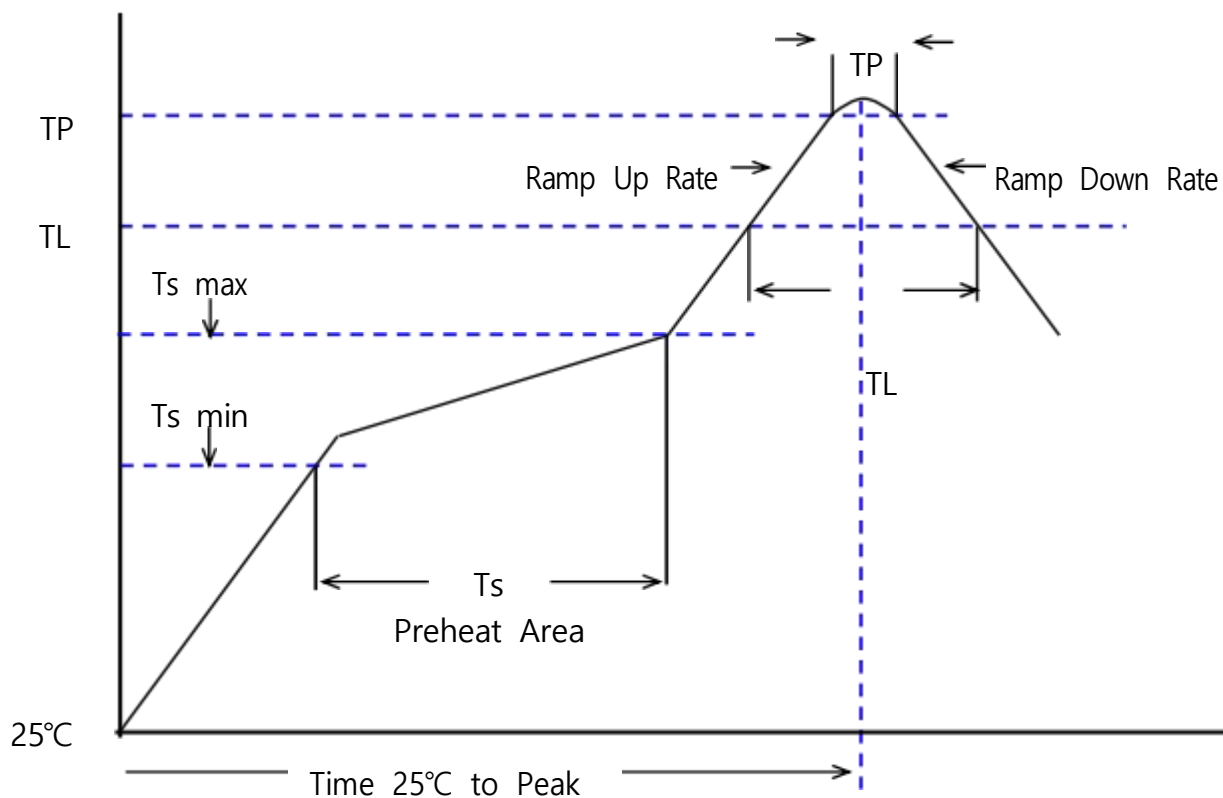

9. 可靠性试验 RELIABILITY SPECIFICATION

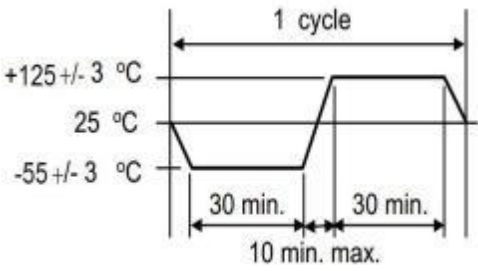
参考标准REFER		JIS C 6701	
NO.	项目 ITEM	测试条件 CONDITIONS	判定标准 Criteria
1	跌落 FREE FALL	从150cm位置高度,自由跌落在木板上,连续3次. FREE DROPPING FROM 150 cm HEIGHT 3 TIMES ON A HARD	电器性能 满足规格要求 THE ELECTRICAL PREFORMAN CE MEET THESPECIFIC ATONN
2	振动 VIBRATION	振动频率： 10~2000 Hz， 振幅： 1.52mm， 时间： 每个方位三面 (X、Y、Z) 各振动2小时 FREQUENCY： 10.2000Hz;AMPLITUDE (TOTAL EXCURSION)： 1.5mm SWEEP TIME： 2-3MIN, 3 DIRECTION(X, Y, Z) EACH FOR 2 Hrs.	
3	温度循环 TEMPERATURE CYCLE	晶体放入试验箱中， 高、低温循环10次 THE CRYSTAL UNIT SHALL BE SUBJECTED TO 10 SUCCESSIVE CHANGE OF TEMPERATURE CYCLE 	
4	冲击 IMOACT	半正弦波冲击 (1000G)： 持续时间： 0.5ms， X,Y,Z三轴各三次时间： 2 小时 HELIUM BOMBING: 3 TIME	
5	可焊性 SOLDERABILI TY	温度： 245±5°C， 浸锡时间： 3±0.5 秒 THE LEAD IS IMMERSIED IN A 245±5°C SOLDER BATH WITHIN 3±0.5 SECONDS.	
6	稳态湿热 HIGH TEMP. & HUMIDITY	温度： 85 ±3°C， 湿度： 85 %， 保持时间： 500个小时 STORED AT 85 ±3°C AND HUMIDITY 85 % FOR 500±12H.	
7	高温存储 HIGH TEMPERATURE STORAGE	高温温度： 125±2°C， 时间： 500±12 个小时 STORED AT 125±2°C FOR 500±12H. 如果客户的温度要求是高于标准,则必须根据客户的要求测试 If Customer's temperature request is higher than the standard, Temperature test must be done for customer requirements	
8	低温存储 LOW TEMPERATURE STORAGE	低温温度： -40±2°C， 时间： 500±12 个小时 STORED AT -40±2°C FOR 500±12H. 如果客户的温度要求是低于标准,则必须根据客户的要求测试 If Customer's temperature request is lower than the standard, Temperature test must be done for customer requirements	

10. 包装数量 NUMBER OF PACKAGES

类型 TYPE	尺寸 SIZE	数量 NUMBER
包装盒 Packaging	180*20*180	3000pcs
包装箱 Packing cases	240*200*200	30000pcs

12. 静电敏感等级 ELECTROSTATIC SENSITIVITY LEVEL

HBM: Class3A

MM: ClassC

CDM: ClassIV

★ 备注:

1. 以上可靠性项目为我司常规测试项目, 若客户对产品有跌落, 冲击, 碰撞以及涉及到超声 波焊接工艺的需求, 请将贵司的需求反馈给我司, 我司会对该产品的可靠性项目进行更新。 2. 客户端在对晶体加热后, 为了保证频率的准确性, 建议将晶体充分冷却后再进行相关测试。 3. 该产品符合公司环保标准要求。

1. The above reliability items are routine test items of our company. If the customer has requirements on the products including drop, impact, collision and ultrasonic wave welding process, please feedback your requirements to our company, and we will update the reliability items of this product. 2. In order to ensure the accuracy of frequency, it is recommended to fully cool the crystal after heating it on the client. 3. The product meets the company's environmental standards.

X-ON Electronics

Largest Supplier of Electrical and Electronic Components

Click to view similar products for [huaxindianzi](#) manufacturer:

Other Similar products are found below :

[1Y012000VP](#) [1Y016000VP](#) [1Y024000VP](#) [1Y025000VP](#) [1Y027000VP](#) [1Y050000VP](#) [2TS019200RP](#) [2TS026000AP](#) [2TS026000RP](#)
[2X019200RP](#) [3X012000TP](#) [3X016384UP](#) [3X019200FP](#) [3X024000QP](#) [3X025000JP](#) [3X027000DP](#) [3X040000JP](#) [3X048000AP](#) [3Y020000VP](#)
[3Y030000VP](#) [3Y032000VP](#) [3Y033333VP](#) [3Y048000VP](#) [3Y100000VP](#) [49D016934CQ](#) [49D032768CQ](#) [49D033868CQ](#) [5Y050000VP](#)
[AD4032K76812001](#) [CF4008M00012001](#) [CF4008M00020001](#) [CF4012M00008001](#) [CF4012M00009001](#) [CF4012M00010001](#)
[CF4012M00012001](#) [CF4012M00020001](#) [CF4013M52110001](#) [CF4013M52120001](#) [CF4013M56010001](#) [CF4013M56020001](#)
[CF4016M00008001](#) [CF4016M00009001](#) [CF4016M00010001](#) [CF4016M00012001](#) [CF4016M00020001](#) [CF4019M20010001](#)
[CF4020M00015001](#) [CF4020M00018001](#) [CF4024M00008001](#) [CF4024M00009001](#)