

## N-Channel Enhancement Mode MOSFET

### Feature

- 100V/100A  
 $R_{DS(ON)}=10m\Omega(\text{typ.}) @V_{GS} = 10V$
- 100% Avalanche Tested
- Reliable and Rugged
- Lead-Free and Green Devices Available (RoHS Compliant)

### Pin Description

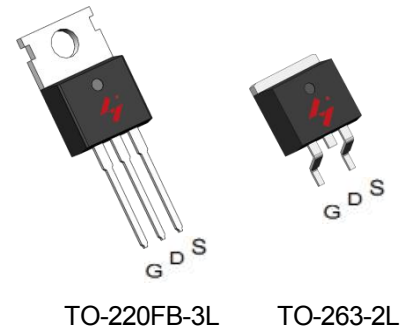

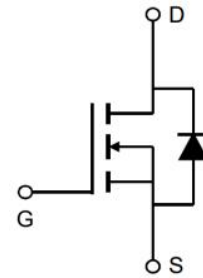

### Applications

- Power Switching application
- Uninterruptible Power Supply



N-Channel MOSFET

### Ordering and Marking Information

|   |   |  |
|---|---|--|
|  P<br><b>HY3010</b><br>YYXXXJWWG |  B<br><b>HY3010</b><br>YYXXXJWWG | Package Code<br>P :TO-220FB-3L      B:TO-263-2L<br><br>Date Code<br>YYXXX WW |
|---|---|--|

Note: HUAYI lead-free products contain molding compounds/die attach materials and 100% matte tin plate Termination finish; which are fully compliant with RoHS. HUAYI lead-free products meet or exceed the lead-Free requirements of IPC/JEDEC J-STD-020 for MSL classification at lead-free peak reflow temperature. HUAYI defines “Green” to mean lead-free (RoHS compliant) and halogen free (Br or Cl does not exceed 900ppm by weight in homogeneous material and total of Br and Cl does not exceed 1500ppm by weight).

HUAYI reserves the right to make changes, corrections, enhancements, modifications, and improvements to this product and/or to this document at any time without notice.

## Absolute Maximum Ratings

| Symbol   | Parameter                                  |          | Rating | Unit |
|--|--|----------|--------|------|
| <b>Common Ratings</b> (Tc=25°C Unless Otherwise Noted) |  |          |        |      |
| V <sub>DSS</sub>                                       | Drain-Source Voltage                       |          | 100    | V    |
| V <sub>GSS</sub>                                       | Gate-Source Voltage                        |          | ±25    | V    |
| T <sub>J</sub>   | Maximum Junction Temperature               |          | 175    | °C   |
| T <sub>STG</sub>                                       | Storage Temperature Range                  |          | -55 to | °C   |
| I <sub>S</sub>   | Source Current-Continuous(Body Diode)      | Tc=25°C  | 100    | A    |
| <b>Mounted on Large Heat Sink</b>                      |  |          |        |      |
| I <sub>DM</sub>  | Pulsed Drain Current *                     | Tc=25°C  | 380**  | A    |
| I <sub>D</sub>   | Continuous Drain Current                   | Tc=25°C  | 100    | A    |
|  |  | Tc=100°C | 74     | A    |
| P <sub>D</sub>   | Maximum Power Dissipation                  | Tc=25°C  | 192    | W    |
|  |  | Tc=100°C | 96     | W    |
| R <sub>θJC</sub>                                       | Thermal Resistance, Junction-to-Case       |          | 0.78   | °C/W |
| R <sub>θJA</sub>                                       | Thermal Resistance, Junction-to-Ambient ** |          | 62.5   | °C/W |
| E <sub>AS</sub>  | Single Pulsed-Avalanche Energy ***         | L=0.5mH  | 575    | mJ   |

Note: \* Repetitive rating; pulse width limited by max. junction temperature.  
 \*\* Surface mounted on FR-4 board.  
 \*\*\* Limited by T<sub>Jmax</sub>, starting T<sub>J</sub>=25°C, L = 0.5mH, V<sub>DS</sub>=80V, V<sub>GS</sub>=10V.

## Electrical Characteristics(Tc =25°C Unless Otherwise Noted)

| Symbol                        | Parameter                        | Test Conditions   | HY3010 |      |      | Unit |
|-------------------------------|----------------------------------|---|--------|------|------|------|
|                               |                                  |   | Min    | Typ. | Max  |      |
| <b>Static Characteristics</b> |                                  |   |        |      |      |      |
| BV <sub>DSS</sub>             | Drain-Source Breakdown Voltage   | V <sub>GS</sub> =0V, I <sub>DS</sub> =250μA               | 100    | -    | -    | V    |
| I <sub>DSS</sub>              | Drain-to-Source Leakage Current  | V <sub>DS</sub> =100V, V <sub>GS</sub> =0V                | -      | -    | 1    | μA   |
|                               |                                  | T <sub>J</sub> =125°C                                     | -      | -    | 10   | μA   |
| V <sub>GS(th)</sub>           | Gate Threshold Voltage           | V <sub>DS</sub> =V <sub>GS</sub> , I <sub>DS</sub> =250μA | 2      | 3    | 4    | V    |
| I <sub>GSS</sub>              | Gate-Source Leakage Current      | V <sub>GS</sub> =±25V, V <sub>DS</sub> =0V                | -      | -    | ±100 | nA   |
| R <sub>DS(ON)*</sub>          | Drain-Source On-State Resistance | V <sub>GS</sub> =10V, I <sub>DS</sub> =50A                | -      | 10   | 12   | mΩ   |
| <b>Diode Characteristics</b>  |                                  |   |        |      |      |      |
| V <sub>SD*</sub>              | Diode Forward Voltage            | I <sub>SD</sub> =50A, V <sub>GS</sub> =0V                 | -      | 0.8  | 1    | V    |
| t <sub>rr</sub>               | Reverse Recovery Time            | I <sub>SD</sub> =50A, dI <sub>SD</sub> /dt=100A/μs        | -      | 35   | -    | ns   |
| Q <sub>rr</sub>               | Reverse Recovery Charge          |   | -      | 50   | -    | nC   |

## Electrical Characteristics (Cont.) (T<sub>c</sub> =25°C Unless Otherwise Noted)

| Symbol                             | Parameter                    | Test Conditions  | HY3010 |      |     | Unit |
|------------------------------------|------------------------------|--|--------|------|-----|------|
|                                    |                              |  | Min    | Typ. | Max |      |
| <b>Dynamic Characteristics</b>     |                              |  |        |      |     |      |
| R <sub>G</sub>                     | Gate Resistance              | V <sub>GS</sub> =0V, V <sub>DS</sub> =0V, F=1 MHz                                    | -      | 1.3  | -   | Ω    |
| C <sub>iss</sub>                   | Input Capacitance            | V <sub>GS</sub> =0V, V <sub>DS</sub> =25V, Frequency=1.0MHz                          | -      | 3100 | -   | pF   |
| C <sub>oss</sub>                   | Output Capacitance           |  |        |      |     |      |
| C <sub>rss</sub>                   | Reverse Transfer Capacitance |  |        |      |     |      |
| t <sub>d(ON)</sub>                 | Turn-on Delay Time           | V <sub>DD</sub> =50V, R <sub>G</sub> =6Ω, I <sub>DS</sub> =50A, V <sub>GS</sub> =10V | -      | 18   | 38  | ns   |
| T <sub>r</sub>                     | Turn-on Rise Time            |  |        |      |     |      |
| t <sub>d(OFF)</sub>                | Turn-off Delay Time          |  |        |      |     |      |
| T <sub>f</sub>                     | Turn-off Fall Time           |  |        |      |     |      |
| <b>Gate Charge Characteristics</b> |                              |  |        |      |     |      |
| Q <sub>g</sub>                     | Total Gate Charge            | V <sub>DS</sub> =80V, V <sub>GS</sub> =10V, I <sub>D</sub> =50A                      | -      | 76   | 100 | nC   |
| Q <sub>gs</sub>                    | Gate-Source Charge           |  |        |      |     |      |
| Q <sub>gd</sub>                    | Gate-Drain Charge            |  |        |      |     |      |

Note: \*Pulse test, pulse width ≤ 300us, duty cycle ≤ 2%

## Typical Operating Characteristics

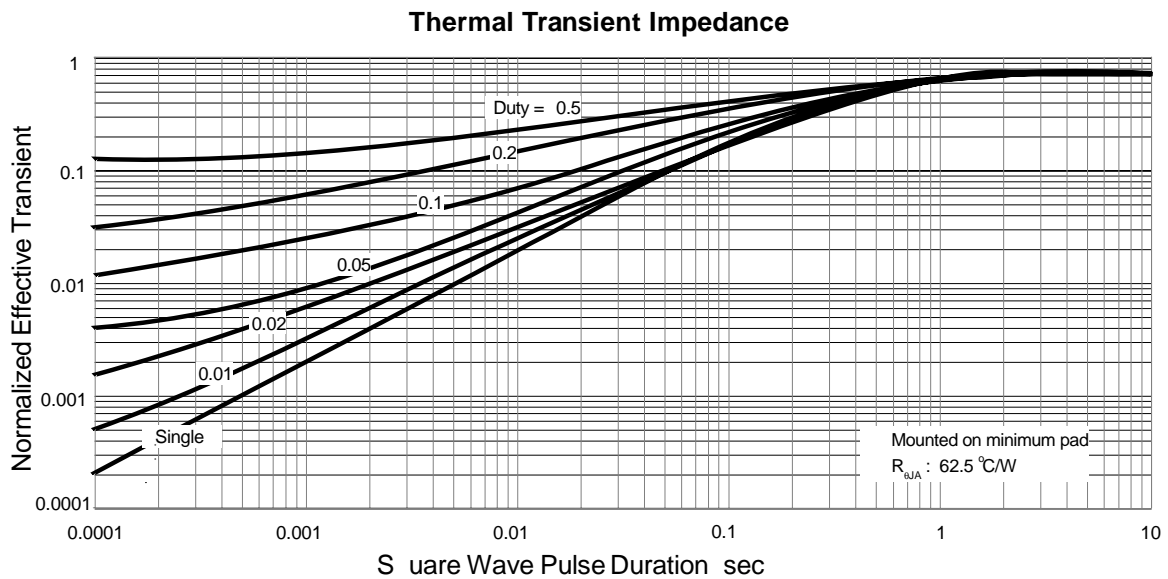
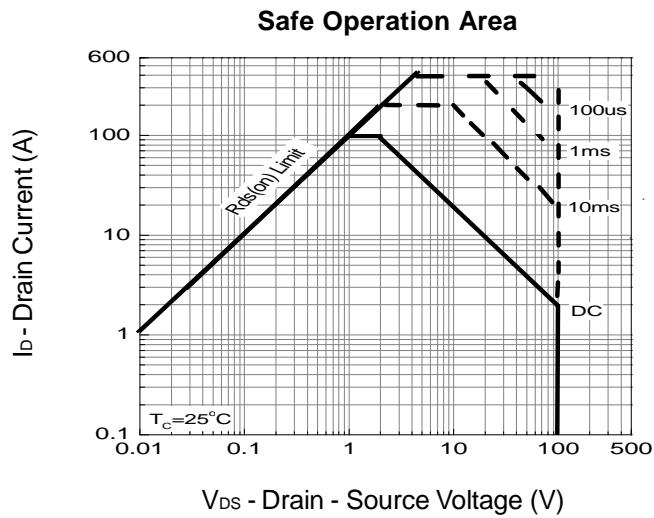
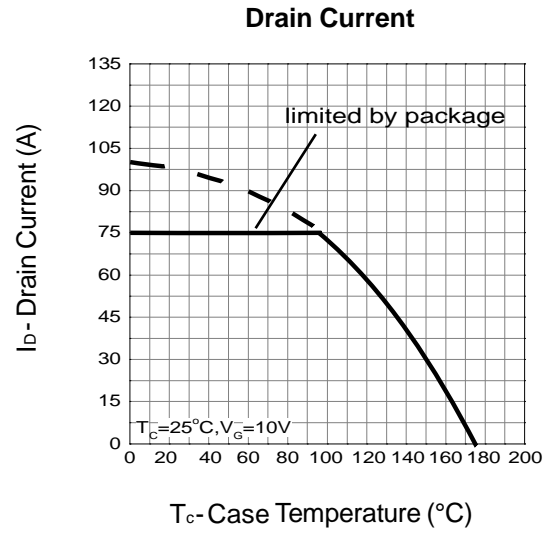
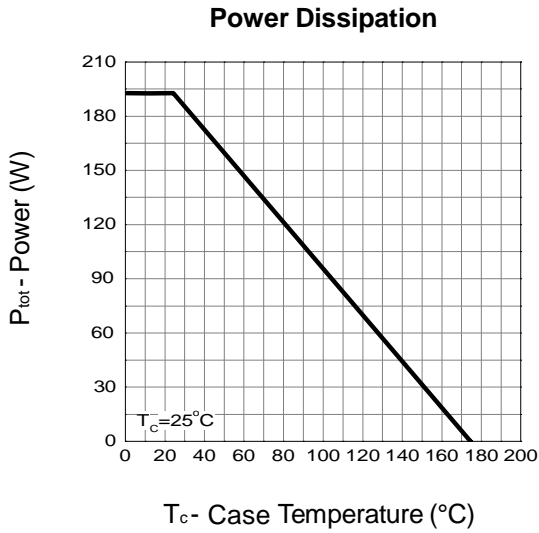

## Typical Operating Characteristics (Cont.)

**Output Characteristics**

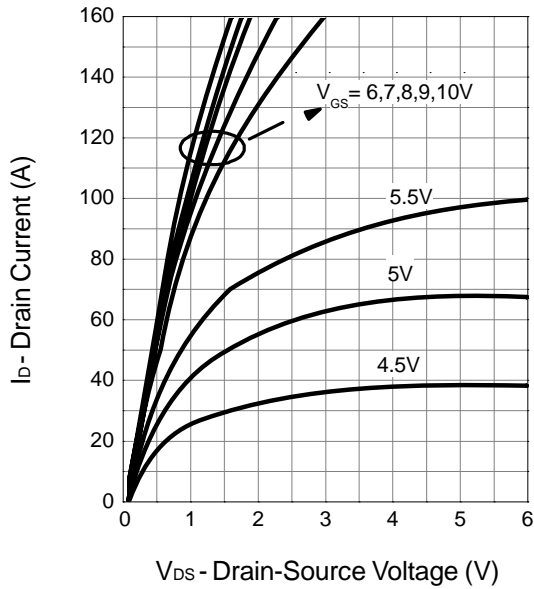

**Drain-Source On Resistance**

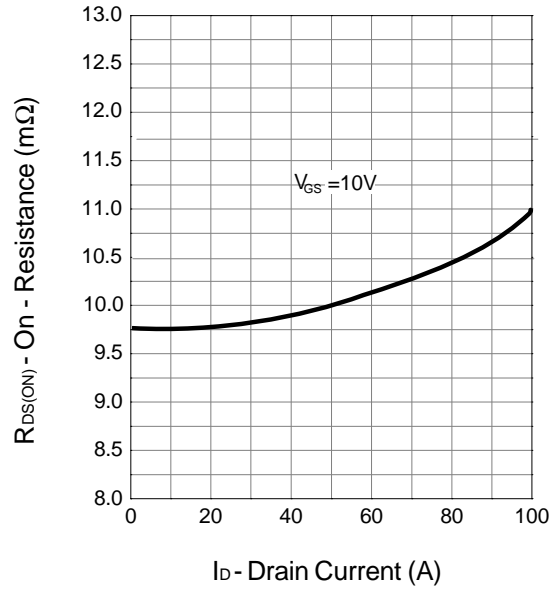

**Drain-Source On Resistance**

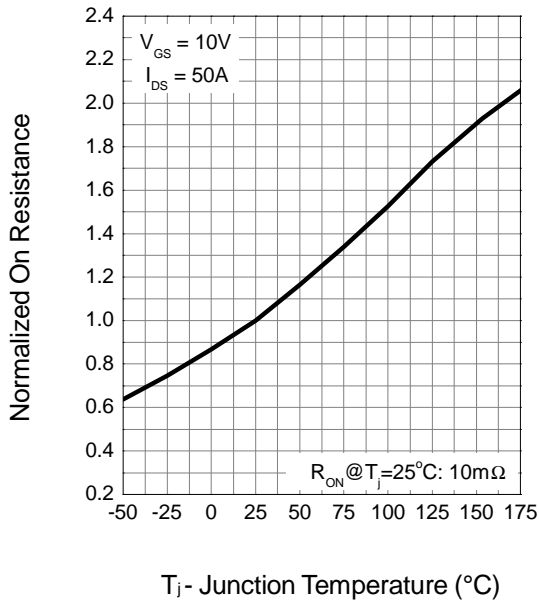

**Source-Drain Diode Forward**

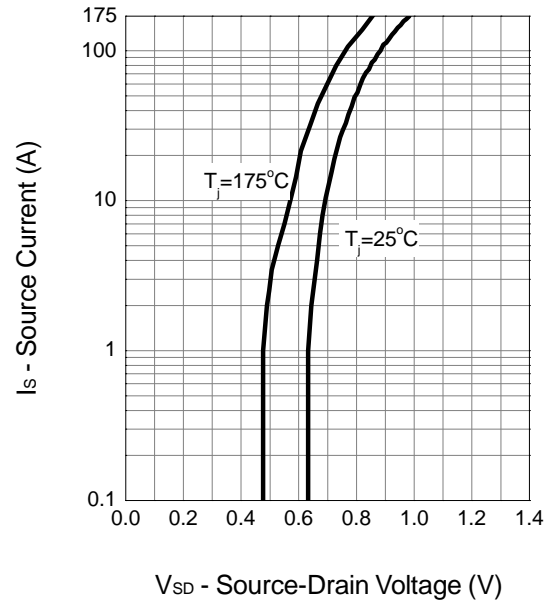

**Typical Operating Characteristics (Cont.)**

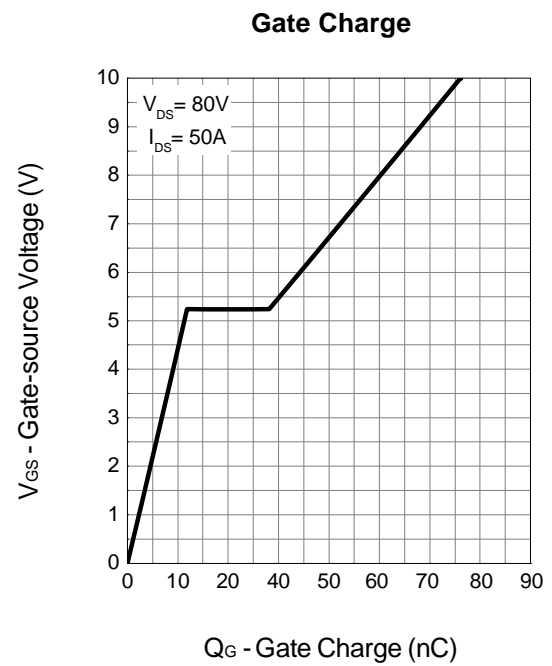
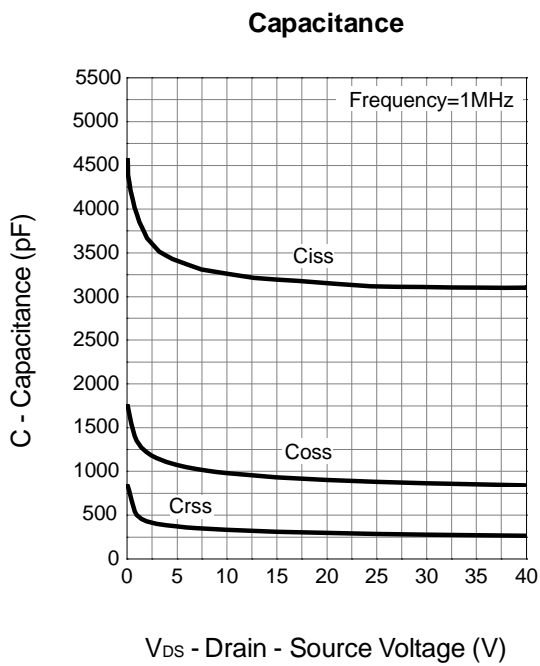

**Avalanche Test Circuit**

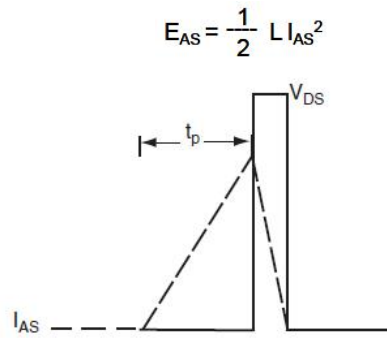
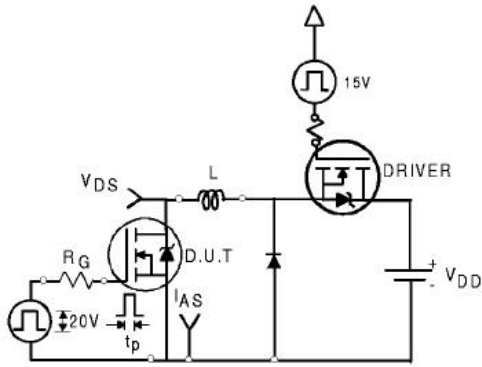

**Switching Time Test Circuit**

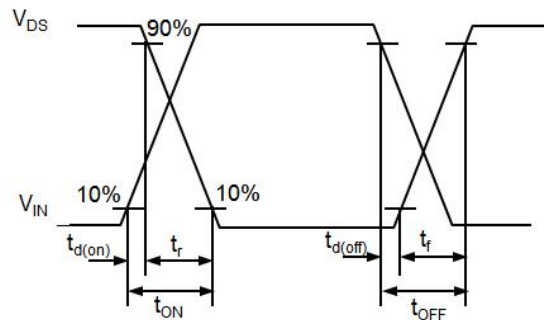
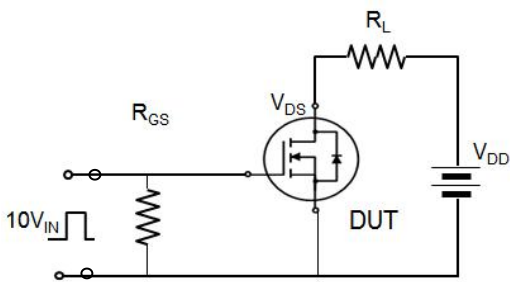

**Gate Charge Test Circuit**

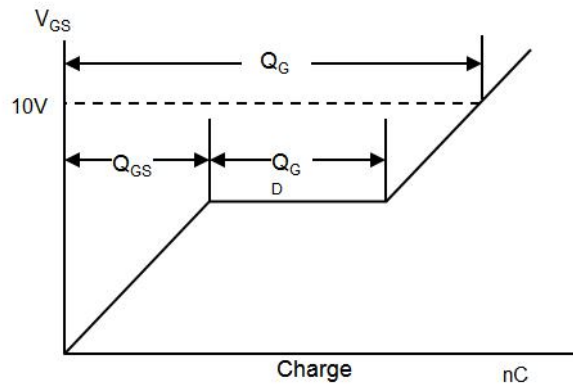
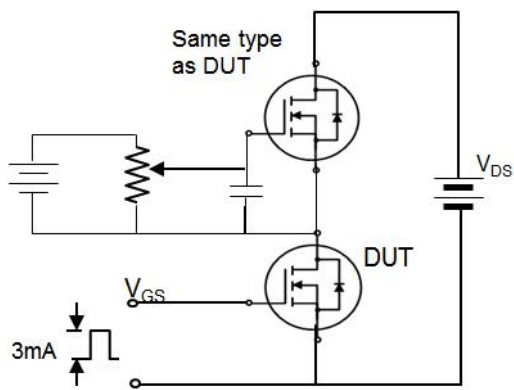

## Device Per Unit

| Package Type | Unit | Quantity |
|--------------|------|----------|
| TO-220FB-3L  | Tube | 50       |
| TO-263-2L    | Tube | 50       |

## Package Information

### TO-220FB-3L

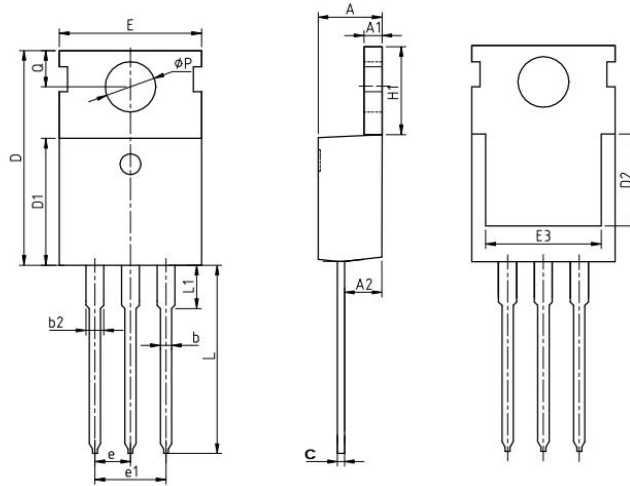

COMMON DIMENSIONS

| SYMBOL | mm       |       |       |
|--------|----------|-------|-------|
|        | MIN      | NOM   | MAX   |
| A      | 4.37     | 4.57  | 4.77  |
| A1     | 1.25     | 1.30  | 1.45  |
| A2     | 2.20     | 2.40  | 2.60  |
| b      | 0.70     | 0.80  | 0.95  |
| b2     | 1.17     | 1.27  | 1.47  |
| c      | 0.40     | 0.50  | 0.65  |
| D      | 15.10    | 15.60 | 16.10 |
| D1     | 8.80     | 9.10  | 9.40  |
| D2     | 5.50     | -     | -     |
| E      | 9.70     | 10.00 | 10.30 |
| E3     | 7.00     | -     | -     |
| e      | 2.54 BSC |       |       |
| e1     | 5.08 BSC |       |       |
| H1     | 6.25     | 6.50  | 6.85  |
| L      | 12.75    | 13.50 | 13.80 |
| L1     | -        | 3.10  | 3.40  |
| ΦP     | 3.40     | 3.60  | 3.80  |
| Q      | 2.60     | 2.80  | 3.00  |



## Package Information

### TO-263-2L

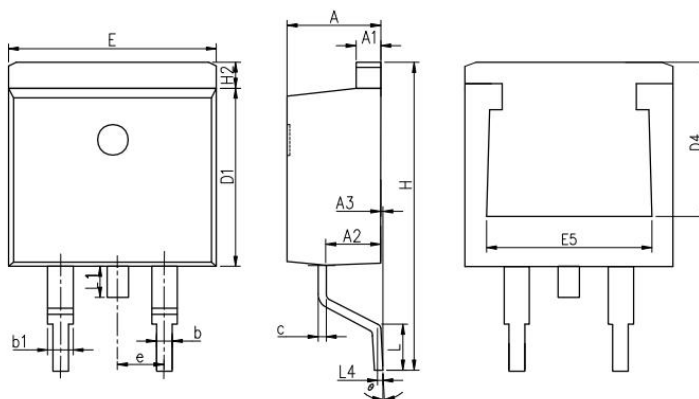

COMMON DIMENSIONS

| SYMBOL   | mm       |       |       |
|----------|----------|-------|-------|
|          | MIN      | NOM   | MAX   |
| A        | 4.37     | 4.57  | 4.77  |
| A1       | 1.22     | 1.27  | 1.42  |
| A2       | 2.49     | 2.69  | 2.89  |
| A3       | 0        | 0.13  | 0.25  |
| b        | 0.7      | 0.81  | 0.96  |
| b1       | 1.17     | 1.27  | 1.47  |
| c        | 0.3      | 0.38  | 0.53  |
| D1       | 8.5      | 8.7   | 8.9   |
| D4       | 6.6      | -     | -     |
| E        | 9.86     | 10.16 | 10.36 |
| E5       | 7.06     | -     | -     |
| e        | 2.54 BSC |       |       |
| H        | 14.7     | 15.1  | 15.5  |
| H2       | 1.07     | 1.27  | 1.47  |
| L        | 2        | 2.3   | 2.6   |
| L1       | 1.4      | 1.55  | 1.7   |
| L4       | 0.25 BSC |       |       |
| $\theta$ | 0°       | 5°    | 9°    |

**Classification Profile**

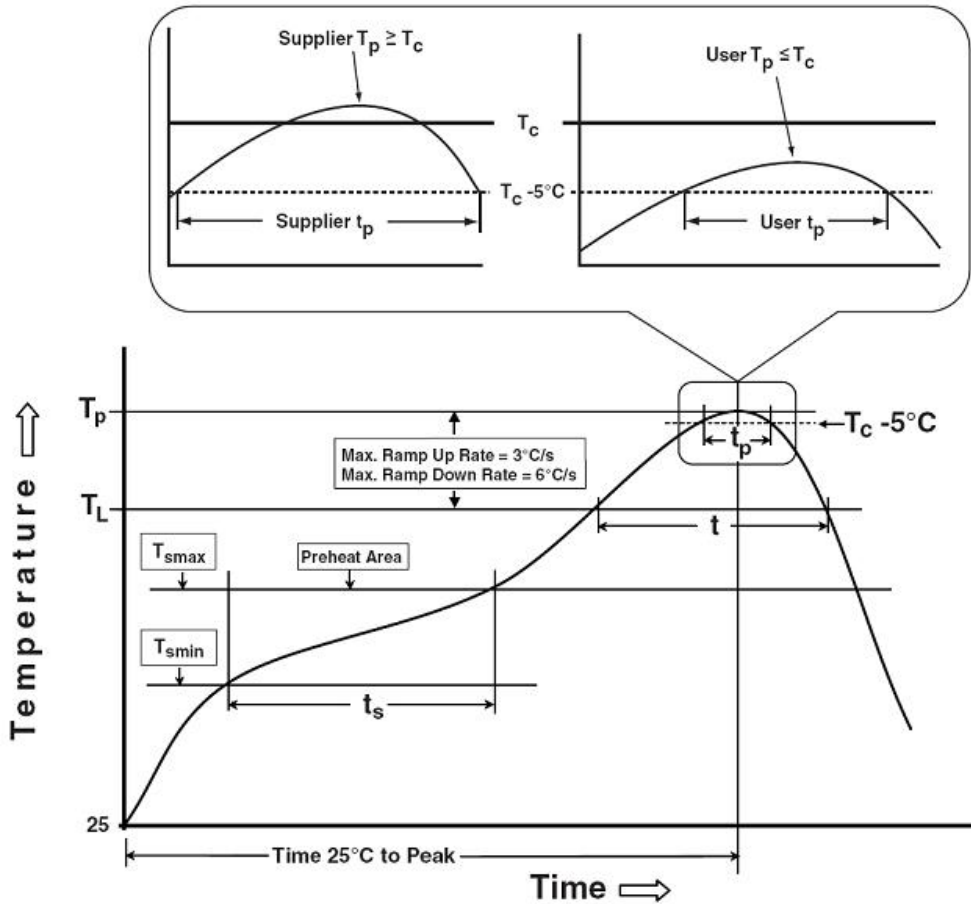

**Classification Reflow Profiles**

| Profile Feature   | Sn-Pb Eutectic Assembly            | Pb-Free Assembly                   |
|---|------------------------------------|------------------------------------|
| <b>Preheat &amp; Soak</b>   |                                    |                                    |
| Temperature min ( $T_{smin}$ )  | 100 °C                             | 150 °C                             |
| Temperature max ( $T_{smax}$ )  | 150 °C                             | 200 °C                             |
| Time ( $T_{smin}$ to $T_{smax}$ ) ( $t_s$ )                                       | 60-120 seconds                     | 60-120 seconds                     |
| Average ramp-up rate ( $T_{smax}$ to $T_p$ )                                      | 3 °C/second max.                   | 3°C/second max.                    |
| Liquidous temperature ( $T_L$ )   | 183 °C                             | 217 °C                             |
| Time at liquidous ( $t_L$ )   | 60-150 seconds                     | 60-150 seconds                     |
| Peak package body Temperature ( $T_p$ )*  | See Classification Temp in table 1 | See Classification Temp in table 2 |
| Time ( $t_p$ )** within 5°C of the specified classification temperature ( $T_c$ ) | 20** seconds                       | 30** seconds                       |
| Average ramp-down rate ( $T_p$ to $T_{smax}$ )                                    | 6 °C/second max.                   | 6 °C/second max.                   |
| Time 25°C to peak temperature   | 6 minutes max.                     | 8 minutes max.                     |

\*Tolerance for peak profile Temperature ( $T_p$ ) is defined as a supplier minimum and a user maximum.

\*\* Tolerance for time at peak profile temperature ( $t_p$ ) is defined as a supplier minimum and a user maximum.

Table 1. SnPb Eutectic Process – Classification Temperatures (Tc)

| Package Thickness | Volume mm <sup>3</sup><br><350 | Volume mm <sup>3</sup><br>≥350 |
|-------------------|--------------------------------|--------------------------------|
| <2.5 mm           | 235 °C                         | 220 °C                         |
| ≥2.5 mm           | 220 °C                         | 220 °C                         |

Table 2. Pb-free Process – Classification Temperatures (Tc)

| Package Thickness | Volume mm <sup>3</sup><br><350 | Volume mm <sup>3</sup><br>350-2000 | Volume mm <sup>3</sup><br>≥2000 |
|-------------------|--------------------------------|------------------------------------|---------------------------------|
| <1.6 mm           | 260 °C                         | 260 °C                             | 260 °C                          |
| 1.6 mm – 2.5 mm   | 260 °C                         | 250 °C                             | 245 °C                          |
| ≥2.5 mm           | 250 °C                         | 245 °C                             | 245 °C                          |

## Reliability Test Program

| Test item     | Method        | Description                    |
|---------------|---------------|--------------------------------|
| SOLDERABILITY | JESD-22, B102 | 5 Sec, 245°C                   |
| HTRB          | JESD-22, A108 | 168/500/1000 Hrs, Bias @ 150°C |
| PCT           | JESD-22, A102 | 96 Hrs, 100%RH, 2atm, 121°C    |
| TCT           | JESD-22, A104 | 500 Cycles, -55°C~150°C        |

### Customer Service

Worldwide Sales and Service: [sales@hymexa.com](mailto:sales@hymexa.com)

Technical Support: [Technology@hymexa.com](mailto:Technology@hymexa.com)

Xi'an Huayi Microelectronics Co., Ltd.

No.8928, Shangji Road, Economic and Technological Development Zone, Xi'an, China

TEL: (86-029) 86685706

FAX: (86-029) 86685705

E-mail: [sales@hymexa.com](mailto:sales@hymexa.com)

Web net: [www.hymexa.com](http://www.hymexa.com)

## X-ON Electronics

Largest Supplier of Electrical and Electronic Components

*Click to view similar products for [MOSFET](#) category:*

*Click to view products by [HUAYI](#) manufacturer:*

Other Similar products are found below :

[614233C](#) [648584F](#) [FDPF9N50NZ](#) [IRFD120](#) [IRFF430](#) [JANTX2N5237](#) [2N7000](#) [FCA20N60\\_F109](#) [FDZ595PZ](#) [2SK2267\(Q\)](#) [2SK2545\(Q,T\)](#)  
[405094E](#) [423220D](#) [MIC4420CM-TR](#) [VN1206L](#) [614234A](#) [715780A](#) [SSM6J414TU,LF\(T](#) [751625C](#) [PSMN4R2-30MLD](#)  
[TK31J60W5,S1VQ\(O](#) [2SK2614\(TE16L1,Q\)](#) [DMN1017UCP3-7](#) [EFC2J004NUZTDG](#) [FCAB21350L1](#) [P85W28HP2F-7071](#) [DMN1053UCP4-7](#)  
[NTE2384](#) [NTE2969](#) [NTE6400A](#) [DMN61D9UWQ-13](#) [US6M2GTR](#) [DMN31D5UDJ-7](#) [SSM6P54TU,LF](#) [DMP22D4UFO-7B](#)  
[IPS60R3K4CEAKMA1](#) [DMN1006UCA6-7](#) [DMN16M9UCA6-7](#) [STF5N65M6](#) [STU5N65M6](#) [C3M0021120D](#) [DMN13M9UCA6-7](#)  
[BSS340NWH6327XTSA1](#) [MCM3400A-TP](#) [DMTH10H4M6SPS-13](#) [IPS60R1K0PFD7SAKMA1](#) [IPS60R360PFD7SAKMA1](#)  
[IPS60R600PFD7SAKMA1](#) [IPS60R210PFD7SAKMA1](#) [DMN2990UFB-7B](#)