



WATERTIGHT WIRING DEVICES



WATERTIGHT WIRING DEVICES APPLICATION GUIDE

WATER TREATMENT

Devices are made to withstand the most abusive environments



FOOD AND BEVERAGE PROCESSING

Rated to withstand harsh, wet environments common to food and beverage facilities



AGRICULTURE

Mud, standing water and abuse are no match for these rugged engineered devices



OUTDOOR ENTERTAINMENT

Power is delivered consistently when the show must go on



FACTORY

Ideal for delivering power to all types of industrial machinery and equipment



CERTIFICATIONS



Known as The Most Trusted Name in Food Safety™, NSF International has been helping businesses in the agriculture, processing, food equipment, restaurant and retail industries to navigate the food safety and regulatory environment for nearly 70 years.

© 2014 NSF International. All rights reserved.



UL is a global independent safety science company with more than a century of expertise innovating safety solutions and is dedicated to promoting safe living and working environments.

© UL and the UL logo are trademarks of UL LLC © 2014 All Rights Reserved.



Products found with this mark means CSA International found that representative samples of this product met CSA's published Standards for Safety intended for the Canadian market.

© UL and CSA logo are trademarks of UL LLC © 2014 All Rights Reserved.





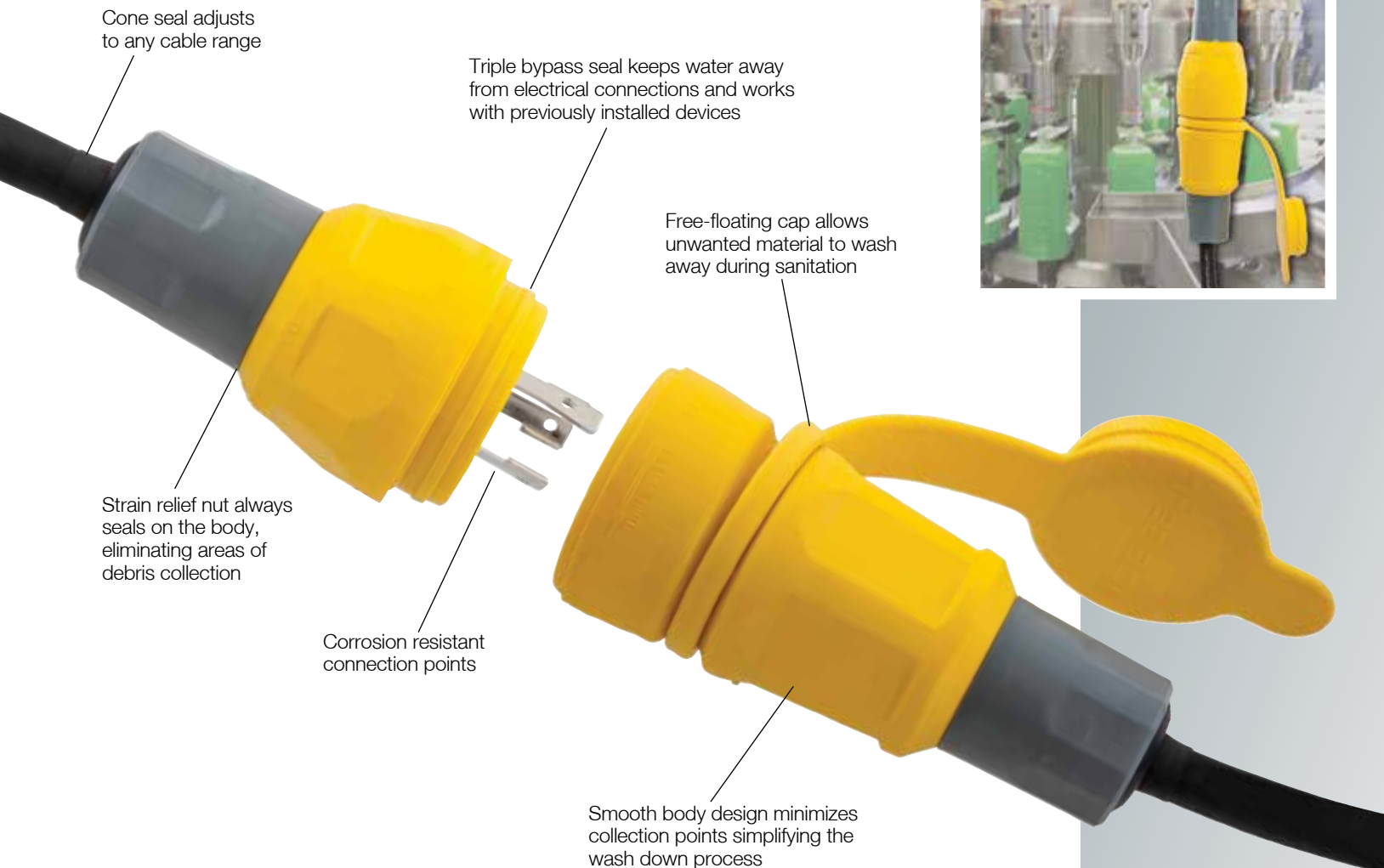
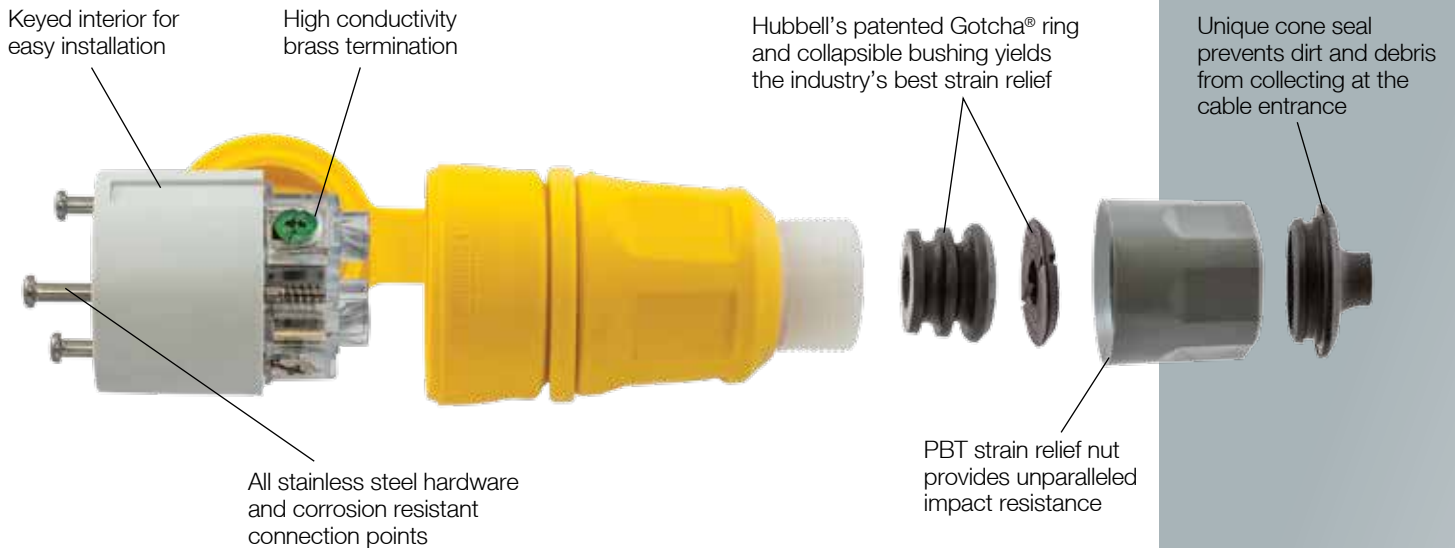

PRODUCT FEATURES

PLUGS AND CONNECTORS

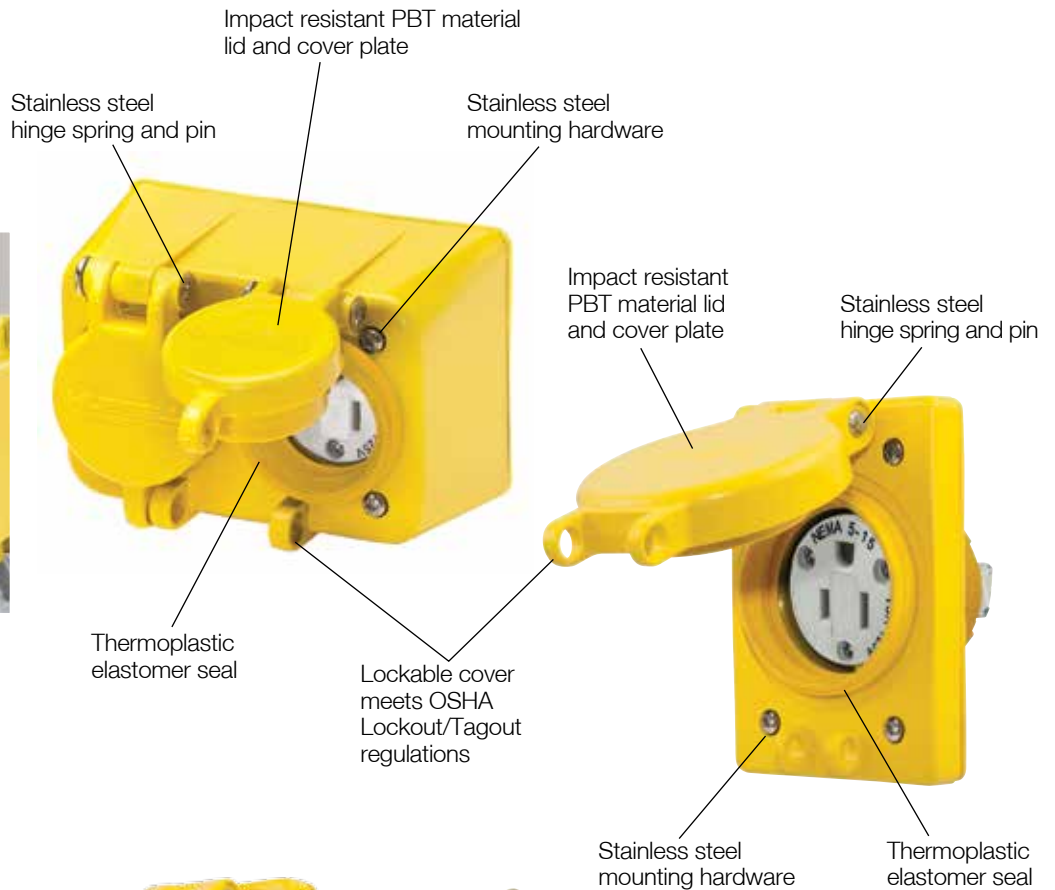

WATERTIGHT WIRING DEVICES





UL Type 4, 4X
IP65, 66, 67
SUITABILITY



HBL60W47



HBL6500





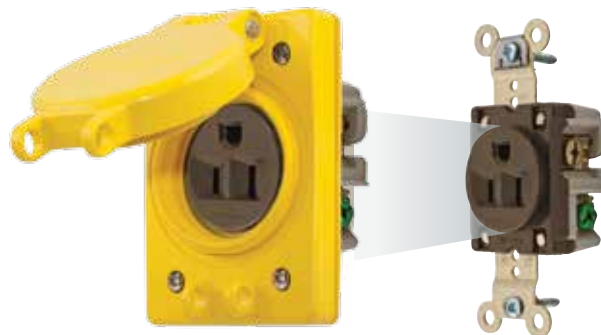







HBL60W47D



Also Available:
 Watertight Lift Covers, for use
 with standard receptacles.

Ordering Information

Straight Blade Devices

	Rating	Plug/ Connector	Poles/ Wires	Color	Plug	Connector	Receptacle with Lift Cover	Duplex Receptacle*
15 Amp	NEMA 5-15 15A 125V	 	2P/3W	Yellow Black	HBL14W47A HBL14W47BK	HBL15W47A HBL15W47BK	HBL60W47 —	HBL60W47D —
	NEMA 6-15 15A 250V	 	2P/3W	Yellow	HBL14W49	HBL15W49	HBL60W49	HBL60W49D
	15A 125V 10A 600V Non-NEMA	 	2P/3W	Yellow	HBL14W07	HBL15W07	—	—
20 Amp	NEMA 5-20 20A 125V	 	2P/3W	Yellow	HBL14W33A	HBL15W33A	HBL60W33	HBL60W33D
	NEMA 6-20 20A 250V	 	2P/3W	Yellow	HBL14W48	HBL15W48	HBL60W48	HBL60W48D

Note: *Duplex receptacles available end of 2nd quarter 2015.



Twist-Lock® Devices

	Rating	Plug/ Connector	Poles/ Wires	Color	Plug	Connector	Receptacle with Lift Cover	Duplex Receptacle*
15 Amp	NEMA L5-15 15A 125V		2P/3W	Yellow Black	HBL24W47A HBL24W47BK	HBL25W47A HBL25W47BK	HBL65W47 —	HBL65W47D —
	NEMA L6-15 15A 250V		2P/3W	Yellow	HBL24W49	HBL25W49	HBL65W49	HBL65W49D
	NEMA L7-15 15A 277V AC		2P/3W	Yellow	HBL24W34	HBL25W34	HBL65W34	HBL65W34D
20 Amp	NEMA L5-20 20A 125V		2P/3W	Yellow Black	HBL26W47 HBL26W47BK	HBL27W47 HBL27W47BK	HBL67W47 —	— —
	NEMA L6-20 20A 250V		2P/3W	Yellow	HBL26W48	HBL27W48	HBL67W48	—
	NEMA L7-20 20A 277V AC		2P/3W	Yellow	HBL26W49	HBL27W49	HBL67W49	—
	NEMA L14-20 20A 125/250V AC		3P/4W	Yellow	HBL26W74	HBL27W74	HBL67W74	—
	NEMA L15-20 20A 3Ø 250V AC		3P/4W	Yellow Black	HBL26W75 HBL26W75BK	HBL27W75 HBL27W75BK	HBL67W75 —	— —
	NEMA L16-20 20A 3Ø 480V AC		3P/4W	Yellow Black	HBL26W76 HBL26W76BK	HBL27W76 HBL27W76BK	HBL67W76 —	— —
	NEMA L21-20 20A 3ØY 120/208V AC		4P/5W	Yellow Black	HBL26W81 HBL26W81BK	HBL27W81 HBL27W81BK	HBL67W81 —	— —
	NEMA L22-20 20A 3ØY 277/480V AC		4P/5W	Yellow	HBL26W82	HBL27W82	HBL67W82	—
	NEMA L23-20 20A 3ØY 347/600V		4P/5W	Yellow	HBL26W83	HBL27W83	HBL67W83	—
	20A 125/250V Non-NEMA		3P/3W	Yellow	HBL26W08	HBL27W08	HBL67W08	—
	20A 3ØY 120/208V AC Non-NEMA		4P/4W	Yellow	HBL26W09	HBL27W09	HBL67W09	—
30 Amp	NEMA L5-30 30A 125V		2P/3W	Yellow Black	HBL28W47 HBL28W47BK	HBL29W47 HBL29W47BK	HBL69W47 —	— —
	NEMA L6-30 30A 250V		2P/3W	Yellow	HBL28W48	HBL29W48	HBL69W48	—
	NEMA L7-30 30A 277V AC		2P/3W	Yellow	HBL28W49	HBL29W49	HBL69W49	—
	NEMA L14-30 30A 125/250V AC		3P/4W	Yellow	HBL28W74	HBL29W74	HBL69W74	—
	NEMA L15-30 30A 3Ø 250V AC		3P/4W	Yellow	HBL28W75	HBL29W75	HBL69W75	—
	NEMA L16-30 30A 3Ø 480V AC		3P/4W	Yellow Black	HBL28W76 HBL28W76BK	HBL29W76 HBL29W76BK	HBL69W76 —	— —
	NEMA L17-30 30A 3Ø 600V AC		3P/4W	Yellow	HBL28W77	HBL29W77	HBL69W77	—
	NEMA L18-30 30A 3ØY 120/208V AC		4P/4W	Yellow	HBL28W78	HBL29W78	—	—
	NEMA L21-30 30A 3ØY 120/208V AC		4P/5W	Yellow Black	HBL28W81 HBL28W81BK	HBL29W81 HBL29W81BK	HBL69W81 —	— —
	NEMA L22-30 30A 3ØY 277/480V AC		4P/5W	Yellow	HBL28W82	HBL29W82	HBL69W82	—
	NEMA L23-30 30A 3ØY 347/600V AC		4P/5W	Yellow	HBL28W83	HBL29W83	HBL69W83	—
	30A 125/250V Non-NEMA		3P/3W	Yellow	HBL28W08	HBL29W08	HBL69W08	—
	30A 3ØY 120/208V AC Non-NEMA		4P/4W	Yellow	HBL28W09	HBL29W09	—	—



NSF UL SP
UL Type 4, 4X, 6P
IP65, 66, 67
SUITABILITY



Note: *Duplex receptacles available end of 2nd quarter 2015.

ACCESSORIES



HBL6500



HBL28W75IN



HBL29W75IN



HBLWTCS2



HBLWTB1



HBL50W50



UL Type 4X

IP65, 66, 67
SUITABILITY

Ordering Information

UL Type 4X Watertight Lift Covers

	Description	Receptacle with Lift Cover
Lift Cover Assembly	For use with 15A or 20A straight blade receptacles and 15A Twist-Lock® receptacles; receptacle not included.	HBL6500
	For use with 20A Twist-Lock® receptacles; receptacle not included.	HBL6700
	Note: When mating with HBL26W09 , 20A Non-NEMA plug, use HBL6800 cover.	
	For use with 30A Twist-Lock® receptacles; receptacle not included.	HBL6800

Interiors

	Device	125V		3Ø 250V AC		3Ø 480V AC	
		Plug	Receptacle	Plug	Receptacle	Plug	Receptacle
15A	Straight Blade Locking	HBL14W47IN	HBL15W47IN	—	—	—	—
		HBL24W47IN	—	—	—	—	—
20A	Locking	—	HBL27W47IN	HBL26W75IN	—	HBL26W76IN	HBL27W76IN
30A	Locking	—	—	HBL28W75IN	HBL29W75IN	HBL28W76IN	HBL29W76IN

Bushings, Cone Seals and Closure Caps

	Device	Bushings	Cone Seals	Closure Caps	
				Yellow	Black
15A	Straight Blade Locking	HBLWTB1	HBLWTCS1	HBL50W50	HBL50W50BK
		HBLWTB1	HBLWTCS1	HBL50W50	HBL50W50BK
20A	Straight Blade Locking	HBLWTB1	HBLWTCS1	HBL50W50	HBL50W50BK
		HBLWTB2	HBLWTCS2	HBL50W52	HBL50W52BK
30A	Locking	HBLWTB3	HBLWTCS3	HBL50W54	HBL50W54BK



FD BOXES AND ANGLED ADAPTERS

Introducing a fully UL Listed surface mount box engineered with features that allow easy, code compliant installation of all types of devices from 15A to 50A, including metallic ground bonding bracket, threaded conduit hubs and external mounting supports. Together with an industry first 55 degree angle adapter, the combination of devices is the only code compliant 45 cu.in. solution for 50A 4 wire installations. The angle adapter can also be installed separately for panel applications.

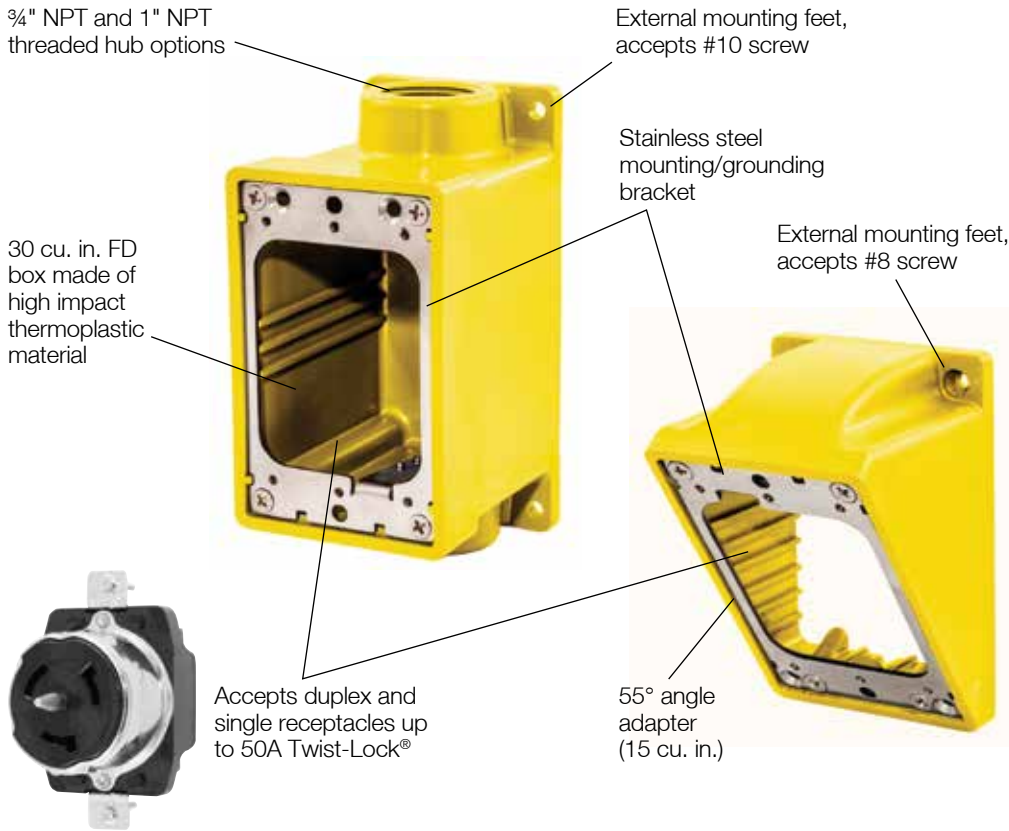

UL Type 4X
IP65, 66
SUITABILITY



HBL60CM83A



HBL60CM55



HBL60CM88



HBLP14FS



HBL60CM88W

Ordering Information

FD Boxes and Angled Adapters*

	Description	Catalog Number
Boxes	(2) 3/4" NPT Hubs, FD Box, Yellow	HBL60CM83A
	(2) 3/4" NPT Hubs, FD Box, White	HBL60CM83WA
	(2) 3/4" NPT Hubs, FD Box, Gray	HBL6083
	(2) 1" NPT Hubs, FD Box, Yellow	HBL60CM84A
	(2) 1" NPT Hubs, FD Box, White	HBL60CM84WA
	(2) 1" NPT Hubs, FD Box, Gray	HBL6084
Adapters	55° Angle Adapter, Yellow	HBL60CM55
	55° Angle Adapter, White	HBL60CM55W
	55° Angle Adapter, Gray	HBL6055
Kits	(2) 3/4" NPT Hubs, Box/Adapter Kit, Yellow	HBL60CM83AK
	(2) 3/4" NPT Hubs, Box/Adapter Kit, White	HBL60CM83WAK
	(2) 3/4" NPT Hubs, Box/Adapter Kit, Gray	HBL6083AK
	(2) 1" NPT Hubs, Box/Adapter Kit, Yellow	HBL60CM84AK
	(2) 1" NPT Hubs, Box/Adapter Kit, White	HBL60CM84WAK
	(2) 1" NPT Hubs, Box/Adapter Kit, Gray	HBL6084AK
Covers	Blank Cover Plate, Yellow	HBL60CM88
	Blank Cover Plate, White	HBL60CM88W
	Blank Cover Plate, Gray	HBLP14FS

Note: *Adapters available end of 2nd quarter 2015. Not UL listed, nor UL Type 4X.



PORTABLE OUTLET BOXES

Wiring room large enough to accommodate the broadest range of device requirements in one size box

Cord entry options include pre-defined range or "Build your own option"

Fully thermoplastic elastomer housing exceeds UL crush requirements and is highly impact resistant, available in black or yellow

Brass inserts for maximum strength

Extended wall protects lift covers from impact damage



Box Suitable for Wet and Damp Locations

IP44
SUITABILITY



Ordering Information

Pre-Assembled Portable Outlet Boxes (with Cord Connector Installed)

	Description	Cord Range Inches (mm)	Catalog Number
Boxes	Portable Outlet Box, Deep, Yellow	.38"-.50" (9.7-12.7)	HBL3099
	Portable Outlet Box, Deep, Feed Thru, Yellow	.38"-.50" (9.7-12.7)	HBL3090F
	Portable Outlet Box, Deep, Yellow with (2) duplex plates	.38"-.50" (9.7-12.7)	HBL3000

Configurable Portable Outlet Boxes

	Empty Box Options	Catalog Number	Cord Range Inches (mm)	Cord Connector Options		Deluxe Cord Connectors
				Gray Nylon	Black Nylon	
Boxes	Outlet Box, Yellow	HBL3080	.38"-.50" (9.5-12.7)	SHC1039CR	—	—
	Outlet Box, Black	HBL3080BK	.50"-.63" (12.7-15.9)	SHC1040CR	SHC2040CR	CG810NM
	Feed Thru Box, Yellow	HBL3080F	.63"-.75" (15.9-19.0)	SHC1041CR	SHC2041CR	074011341
	Feed Thru Box, Black	HBL3080FBK	.75"-.88" (19.0-22.2)	SHC1042CR	SHC2042CR	074011342
			.88"-1.00" (22.2-25.4)	SHC1043CR	SHC2043CR	074011343
			.59"-1.00" (15.0-25.4)	SEC100GA	SEC100BA	—

Note: Includes Locknut.



COVER PLATES FOR PORTABLE OUTLET BOXES AND PANELS

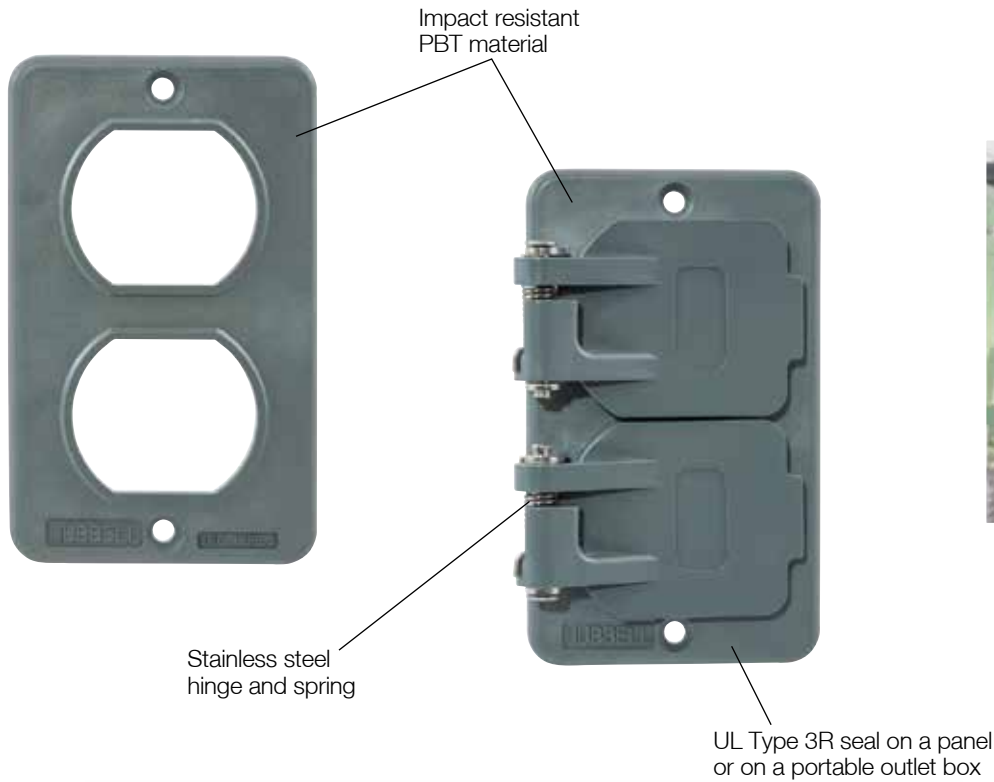

UL **SF**
UL Type 3R
IP44
SUITABILITY



UL Type 1



Ordering Information

Cover Plates for Portable Outlet Boxes and Panels

	Description	UL Type 3R	UL Type 1
Cover Plates	Outlet box cover, duplex receptacle	HBL3056	HBL3051
	Outlet box cover, 1.39" diameter receptacle	HBL3057	HBL3052
	Outlet box cover, 1.572" diameter receptacle	HBL3058	HBL3055
	Outlet box cover; GFCI	HBL3061	HBL3060
	Outlet box coverplate, blank	HBL3054	—

SPECIFICATIONS

Materials

Plug/Connector

Part	Materials
Blade/Contact Carrier	Nylon, white
Terminal Retainer	Polycarbonate, clear
Housing	Thermoplastic elastomer
Housing Insert	Nylon, white
Strain Relief Nut	PBT thermoplastic, gray
Blades/Contacts	Brass, nickel plated
Terminal Screws	Brass
Terminal Screw Size	#8-32 15A/20A Straight Blade and 15A Twist-Lock; #10-32 20A and 30A Twist-Lock
Assembly Screws	Stainless Steel
Bushings	Thermoplastic elastomer, black
Gotcha Ring	Nylon
Cone Seal	Thermoplastic elastomer, black
Closure Cap	Thermoplastic elastomer

Receptacle Assembly

Part	Materials
Base, Flip Lid, and Backplate	PBT
Seal Collar	Thermoplastic elastomer
Mounting Screws	Stainless Steel
Spring and Hinge Pin	Stainless Steel

Portable Outlet Box and Accessories

Part	Materials
Box Enclosure	Thermoplastic elastomer
Strain Relief Nut	PBT
Grommet	Thermoplastic elastomer
Gotcha Ring	Nylon
Locknut	Steel, zinc plate
Threaded Inserts	Brass
Receptacle Screw	Stainless steel
Cover Plate	PBT
Cover Plate Seal	Neoprene
Cover Plate Spring	Stainless steel
Hinge Pin	Stainless steel
Hinge Bracket	Zinc plated steel
Rivets	Zinc plated steel

Performance

Electrical

Dielectric Voltage	
Connectors:	2000V AC if rated 300V or less; 3000V AC if rated above 300V
Plugs:	2500V AC if rated 300V or less; 3500V AC if rated above 300V
Max Working Voltage	As marked
Current Interrupting	Rated for current interruption per UL498
Temperature Rise	30°C max per UL498 at rated current

Mechanical

Cord and terminal accommodations:

Plugs and Connectors

15 and 20A Straight Blade and 15A Locking	16/3 SJ to 10/3 SJ, 18/3 S to 12/3 S, (Ø.325" to Ø625") (Ø8.3mm to Ø15.9 mm)
20A Locking Except HBL26W09 & HBL27W09	Min. Cord: 16/3 SJ, 18/3 S, 18/4 SJ, 18/4 S, 18/5 S, (Ø.325") (Ø8.3 mm) Max. Cord: 10/3 S, 10/4 S, 10/5 S (.875") (22.2 mm)
30A Locking Including HBL26W09 & HBL27W09	Min Cords: 12/3 SJ, 16/3 S, 14/4 SJ, 18/4 S, 18/5 S, (Ø.375") (Ø9.5 mm) Max Cord: 8/3 S, 8/4 S, 10/5 S (1.125") (28.6 mm)

Receptacles – use solid or stranded building wire or flexible cord only as outlined below:

All Straight Blade	18 AWG to 10 AWG
15A Locking	18 AWG to 10 AWG
20A and 30A Locking	18 AWG to 8 AWG

Portable Outlet Boxes

Cord Range	.38" to .68" (HBL3099, HBL3090F, HBL3000) .38" to 1.00" with user-specified cord connector
Wiring Volume	19.0 in ³

Environmental

Moisture Resistance	UL Listed to 3R, 3RX, 4, 4X, 6, 6P, 12 (Plugs and connectors); 3R, 3RX, 4, 4X (Receptacles); Wet and Damp Locations (Portable outlet boxes); Covers (POB) UL Type 3R and Wet Locations cover closed
Flammability	UL94V0 (boxes, covers, and plates); UL94V2 (Plugs, connectors, and interiors); UL94HB (Caps, bushings, and cone seals)
Operating Temperatures	-40°C (without impact) to +60°C continuous
UV Resistance	All exposed materials are UV stabilized

Specifications

Listings (Plug/Connector and Flip Lid Assembly)

Listed to UL498
 Certified to CSA C22.2 No. 42
 Meets NEMA WD-1, WD-6, and ANSI standards
 IP66 Suitability
 NSF Certified (Plugs, Connectors and Receptacles)

FD Box/Adapter

Part	Materials
Box Enclosure	PBT
Ground Bracket	316 Stainless Steel
Ground Screw	Brass
Angle Adapter	PBT

Environmental

Box	UL Type 4X (with UL Type 4X receptacle assembly) UL Type 3R (with weatherproof cover plate)
-----	--

DIMENSIONS

Plugs and Connectors Inches (mm)

		15A & 20A	15A Non-NEMA	15A	20A	30A
		Straight Blade	Straight Blade	Twist-Lock®	Twist-Lock®	Twist-Lock®
Plugs	A	1.85 (47.07)	1.63 (41.40)	1.85 (47.07)	2.51 (63.70)	2.77 (70.41)
	B	3.16 (80.27)	2.68 (68.00)	3.21 (81.46)	3.96 (100.69)	3.94 (99.98)
Connectors	C	1.85 (47.07)	1.80 (46.00)	1.85 (47.07)	2.51 (63.70)	2.77 (70.41)
	D	4.42 (112.14)	4.00 (102.00)	4.62 (117.22)	5.69 (144.55)	5.67 (144.00)

Note: For HBL26W09 and HBL27W09 use 30A Twist-Lock® dimensions.

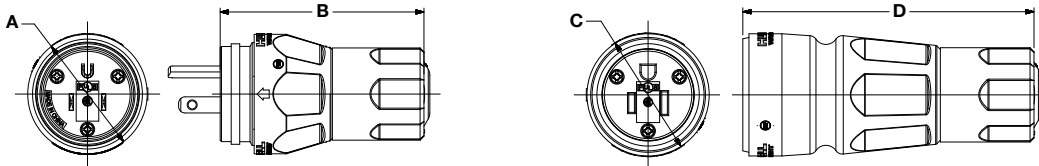

Receptacles with Lift Covers Inches (mm)

	15A & 20A	15A	20A	20A	30A	30A
	Straight Blade	Twist-Lock®	Twist-Lock®	Non-NEMA	Twist-Lock®	Non-NEMA
A	4.56" (115.9)	4.56" (115.9)	4.56" (115.9)	4.56" (115.9)	4.56" (115.9)	4.56" (115.9)
B	3.10" (78.7)	3.10" (78.7)	3.10" (78.7)	3.10" (78.7)	3.10" (78.7)	3.10" (78.7)
C	1.20" (30.6)	1.20" (30.6)	1.20" (30.6)	1.20" (30.6)	1.20" (30.6)	1.20" (30.6)
D	3.25" (82.6)	3.25" (82.6)	3.25" (82.6)	3.25" (82.6)	3.25" (82.6)	3.25" (82.6)
E	1.88" (47.6)	1.88" (47.6)	1.88" (47.6)	1.88" (47.6)	1.88" (47.6)	1.88" (47.6)
F	1.26" (32.0)	1.46" (37.1)	1.72" (43.7)	2.26" (57.4)	1.72" (43.7)	1.97" (50.0)
G	1.63" (41.4)	1.63" (41.4)	2.25" (57.2)	2.25" (57.2)	2.25" (57.2)	2.25" (57.2)
H	5.00" (127.0)	5.00" (127.0)	5.00" (127.0)	5.00" (127.0)	5.00" (127.0)	5.00" (127.0)

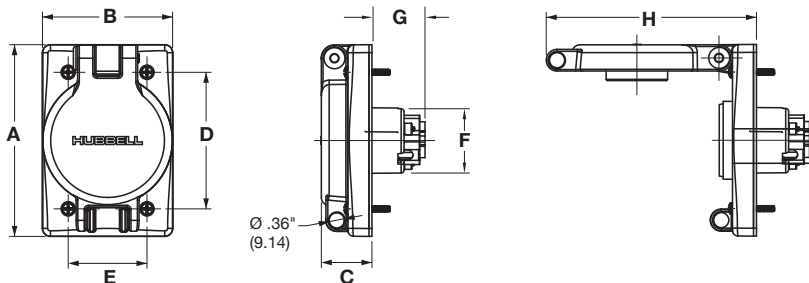

Portable Outlet Boxes Inches (mm)

	Pre-Assembled	Configurable
A	4.30" (109.2)	4.30" (109.2)
B	5.00" (127.0)	5.00" (127.0)
C	2.77" (70.4)	2.77" (70.4)
D	3.28" (83.3)	3.28" (83.3)
E	5.79" (147.0)	—
F	7.28" (184.9)	—

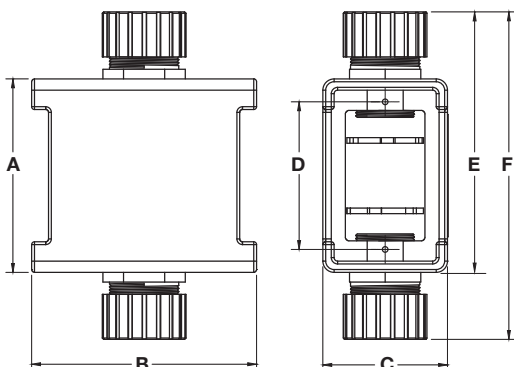

Cover Plates Inches (mm)

A	3.78" (96.0)
B	2.28" (57.9)
C	0.27" (6.9)
D	3.28" (83.3)
E	1.87" (47.5)
F	3.25" (82.6)

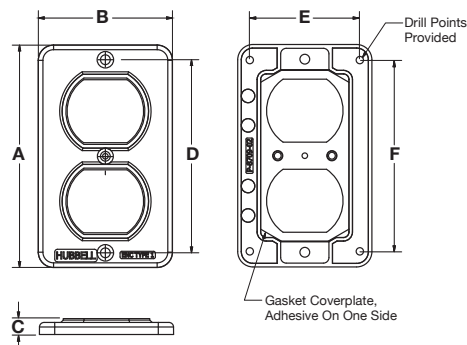

Style shown is representative of all openings.

WATERTIGHT WIRING DEVICES

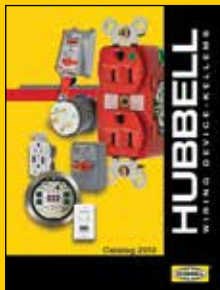

2013 Full Line Catalog

The new Hubbell Wiring Device-Kellems catalog showcases our enhanced product offering to provide a breadth of solutions for the industrial, commercial and residential markets.



Hubbell Safety Brochure

Hubbell has always been focused on safety. That's why Hubbell products are designed and developed to first provide maximum safety against injury and the potential dangers of electricity.

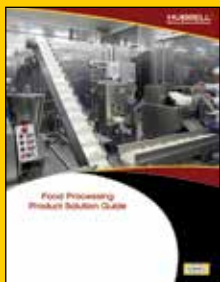

Hubbell Food Processing Brochure

Hubbell's food processing guide identifies Wiring Device-Kellems product solutions for areas where water, corrosiveness, harsh temperature and personal protection are required. Food processing is a demanding environment and Hubbell has the right products to keep production moving safely.

Twist-Lock® App

When you're on the go... Use the New Twist-Lock® App from Hubbell®.



Download it today!



X-ON Electronics

Largest Supplier of Electrical and Electronic Components

Click to view similar products for [hubbell](#) manufacturer:

Other Similar products are found below :

[CFB7TALU](#) [03301045](#) [02216024](#) [03301047](#) [5369VY](#) [5461](#) [WSS1P](#) [00322005LPK50](#) [01304055](#) [M001SG000](#) [M001SG00P](#) [M11MSP](#)
[01301013](#) [02201005](#) [02202008](#) [02203007](#) [02203064](#) [02206012](#) [02211003](#) [02211019](#) [02402005](#) [02406006](#) [02407008](#) [CS1223GY](#) [CS6360C](#)
[CS6370](#) [7310](#) [MCMA14110](#) [7485VBLK](#) [7585](#) [7716](#) [7967](#) [FF3I](#) [PF2004PA005](#) [PFOLT312](#) [PH2003PA010](#) [PH2304PB050](#) [PH6598W](#) [9308](#)
[GFP2305](#) [GFR5352IA](#) [GFR5362WTR](#) [GFR8300SNAPBKNA](#) [PM3004PA015](#) [HBL13R12D](#) [HBL16LEDR](#) [HBL18201WCN](#)
[HBL20GBA612IV](#) [HBL20IG606GY](#) [HBL2441](#)