

WATERTIGHT WIRING DEVICES



WATERTIGHT WIRING DEVICES APPLICATION GUIDE

WATER TREATMENT

Devices are made to withstand the most abusive environments



FOOD AND BEVERAGE PROCESSING

Rated to withstand harsh, wet environments common to food and beverage facilities



AGRICULTURE

Mud, standing water and abuse are no match for these rugged engineered devices



OUTDOOR ENTERTAINMENT

Power is delivered consistently when the show must go on



FACTORY

Ideal for delivering power to all types of industrial machinery and equipment



CERTIFICATIONS



Known as The Most Trusted Name in Food Safety™, NSF International has been helping businesses in the agriculture, processing, food equipment, restaurant and retail industries to navigate the food safety and regulatory environment for nearly 70 years.

© 2014 NSF International. All rights reserved.



UL is a global independent safety science company with more than a century of expertise innovating safety solutions and is dedicated to promoting safe living and working environments.

© UL and the UL logo are trademarks of UL LLC © 2014 All Rights Reserved.



Products found with this mark means CSA International found that representative samples of this product met CSA's published Standards for Safety intended for the Canadian market.

© UL and CSA logo are trademarks of UL LLC © 2014 All Rights Reserved.





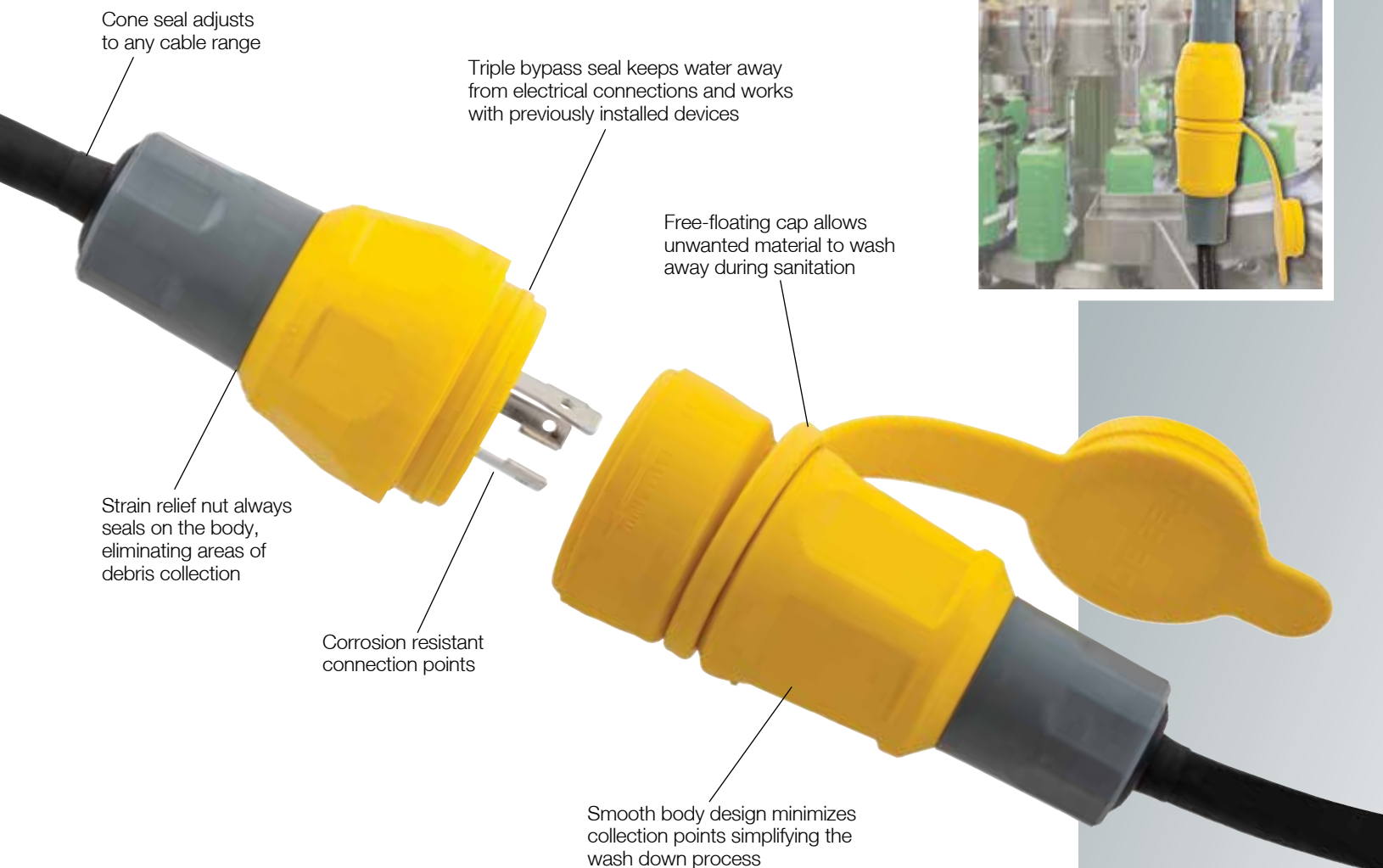
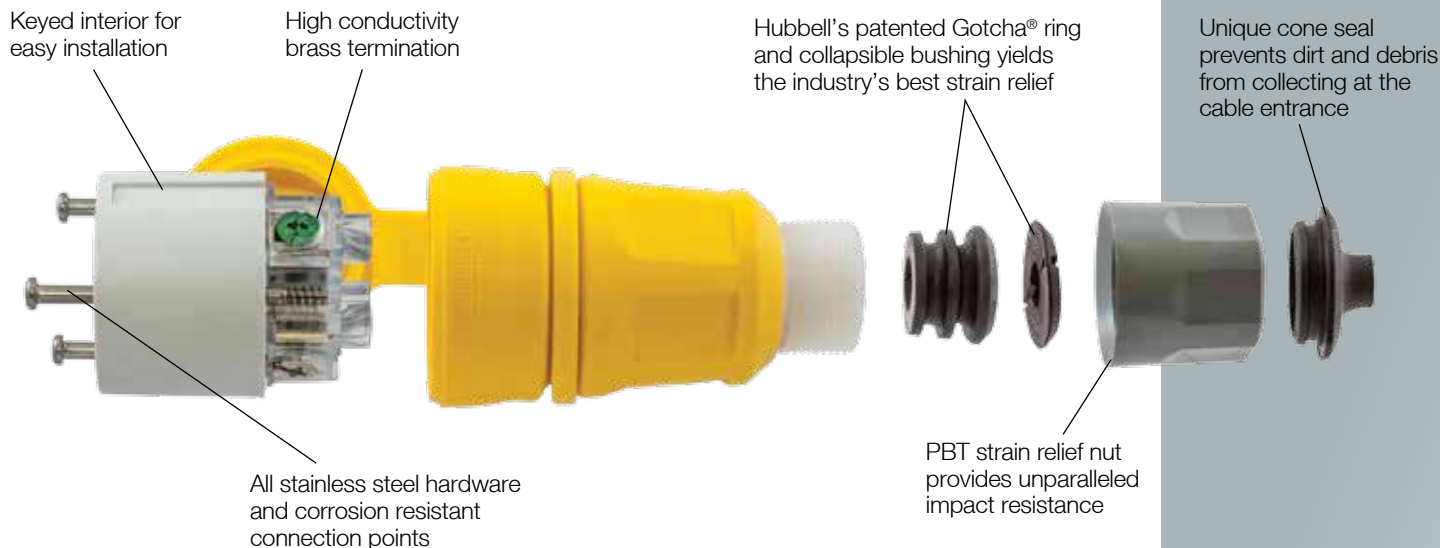

PRODUCT FEATURES

PLUGS AND CONNECTORS

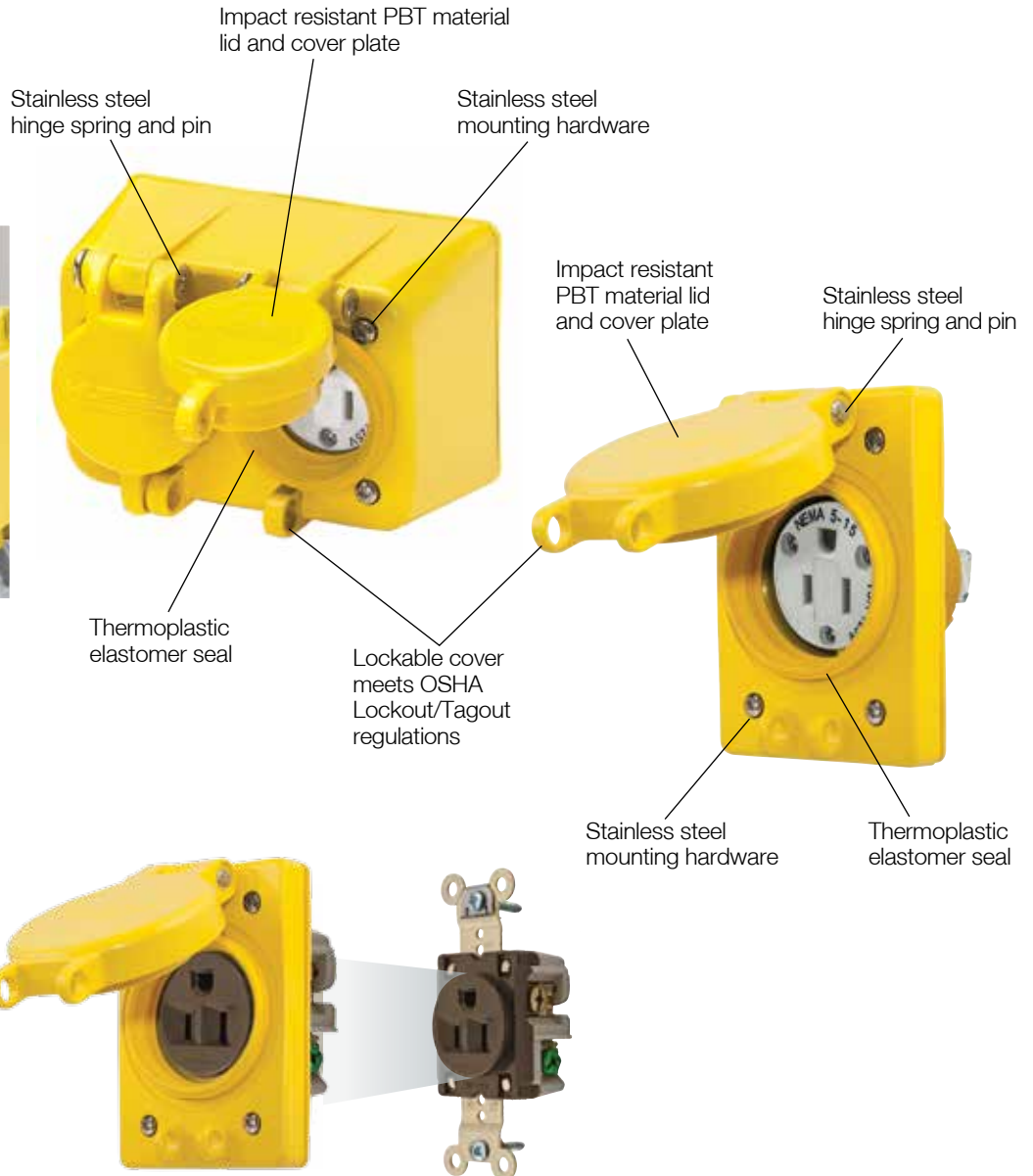

WATERTIGHT WIRING DEVICES





UL Type 4, 4X
IP65, 66, 67
SUITABILITY



HBL60W47



HBL6500













HBL60W47D

Also Available:
 Watertight Lift Covers, for use
 with standard receptacles.

Ordering Information

Straight Blade Devices

| | Rating | Plug/ Connector | Poles/ Wires | Color | Plug | Connector | Receptacle with Lift Cover | Duplex Receptacle* |
|--------|----------------------------------|---|-----------------|-----------------|---------------------------------------|---------------------------------------|-------------------------------|-----------------------|
| 15 Amp | NEMA 5-15 15A 125V |   | 2P/3W | Yellow Black | HBL14W47A HBL14W47BK | HBL15W47A HBL15W47BK | HBL60W47 — | HBL60W47D — |
| | NEMA 6-15 15A 250V |   | 2P/3W | Yellow | HBL14W49 | HBL15W49 | HBL60W49 | HBL60W49D |
| | 15A 125V 10A 600V Non-NEMA |   | 2P/3W | Yellow | HBL14W07 | HBL15W07 | — | — |
| 20 Amp | NEMA 5-20 20A 125V |   | 2P/3W | Yellow | HBL14W33A | HBL15W33A | HBL60W33 | HBL60W33D |
| | NEMA 6-20 20A 250V |   | 2P/3W | Yellow | HBL14W48 | HBL15W48 | HBL60W48 | HBL60W48D |

Note: *Duplex receptacles available end of 2nd quarter 2015.



Twist-Lock® Devices

| | Rating | Plug/ Connector | Poles/ Wires | Color | Plug | Connector | Receptacle with Lift Cover | Duplex Receptacle* |
|--------|------------------------------------|--------------------|-----------------|-----------------|---------------------------------------|---------------------------------------|-------------------------------|-----------------------|
| 15 Amp | NEMA L5-15 15A 125V | | 2P/3W | Yellow Black | HBL24W47A HBL24W47BK | HBL25W47A HBL25W47BK | HBL65W47 — | HBL65W47D — |
| | NEMA L6-15 15A 250V | | 2P/3W | Yellow | HBL24W49 | HBL25W49 | HBL65W49 | HBL65W49D |
| | NEMA L7-15 15A 277V AC | | 2P/3W | Yellow | HBL24W34 | HBL25W34 | HBL65W34 | HBL65W34D |
| 20 Amp | NEMA L5-20 20A 125V | | 2P/3W | Yellow Black | HBL26W47 HBL26W47BK | HBL27W47 HBL27W47BK | HBL67W47 — | — — |
| | NEMA L6-20 20A 250V | | 2P/3W | Yellow | HBL26W48 | HBL27W48 | HBL67W48 | — |
| | NEMA L7-20 20A 277V AC | | 2P/3W | Yellow | HBL26W49 | HBL27W49 | HBL67W49 | — |
| | NEMA L14-20 20A 125/250V AC | | 3P/4W | Yellow | HBL26W74 | HBL27W74 | HBL67W74 | — |
| | NEMA L15-20 20A 3Ø 250V AC | | 3P/4W | Yellow Black | HBL26W75 HBL26W75BK | HBL27W75 HBL27W75BK | HBL67W75 — | — — |
| | NEMA L16-20 20A 3Ø 480V AC | | 3P/4W | Yellow Black | HBL26W76 HBL26W76BK | HBL27W76 HBL27W76BK | HBL67W76 — | — — |
| | NEMA L21-20 20A 3ØY 120/208V AC | | 4P/5W | Yellow Black | HBL26W81 HBL26W81BK | HBL27W81 HBL27W81BK | HBL67W81 — | — — |
| | NEMA L22-20 20A 3ØY 277/480V AC | | 4P/5W | Yellow | HBL26W82 | HBL27W82 | HBL67W82 | — |
| | NEMA L23-20 20A 3ØY 347/600V | | 4P/5W | Yellow | HBL26W83 | HBL27W83 | HBL67W83 | — |
| | 20A 125/250V Non-NEMA | | 3P/3W | Yellow | HBL26W08 | HBL27W08 | HBL67W08 | — |
| | 20A 3ØY 120/208V AC Non-NEMA | | 4P/4W | Yellow | HBL26W09 | HBL27W09 | HBL67W09 | — |
| 30 Amp | NEMA L5-30 30A 125V | | 2P/3W | Yellow Black | HBL28W47 HBL28W47BK | HBL29W47 HBL29W47BK | HBL69W47 — | — — |
| | NEMA L6-30 30A 250V | | 2P/3W | Yellow | HBL28W48 | HBL29W48 | HBL69W48 | — |
| | NEMA L7-30 30A 277V AC | | 2P/3W | Yellow | HBL28W49 | HBL29W49 | HBL69W49 | — |
| | NEMA L14-30 30A 125/250V AC | | 3P/4W | Yellow | HBL28W74 | HBL29W74 | HBL69W74 | — |
| | NEMA L15-30 30A 3Ø 250V AC | | 3P/4W | Yellow | HBL28W75 | HBL29W75 | HBL69W75 | — |
| | NEMA L16-30 30A 3Ø 480V AC | | 3P/4W | Yellow Black | HBL28W76 HBL28W76BK | HBL29W76 HBL29W76BK | HBL69W76 — | — — |
| | NEMA L17-30 30A 3Ø 600V AC | | 3P/4W | Yellow | HBL28W77 | HBL29W77 | HBL69W77 | — |
| | NEMA L18-30 30A 3ØY 120/208V AC | | 4P/4W | Yellow | HBL28W78 | HBL29W78 | — | — |
| | NEMA L21-30 30A 3ØY 120/208V AC | | 4P/5W | Yellow Black | HBL28W81 HBL28W81BK | HBL29W81 HBL29W81BK | HBL69W81 — | — — |
| | NEMA L22-30 30A 3ØY 277/480V AC | | 4P/5W | Yellow | HBL28W82 | HBL29W82 | HBL69W82 | — |
| | NEMA L23-30 30A 3ØY 347/600V AC | | 4P/5W | Yellow | HBL28W83 | HBL29W83 | HBL69W83 | — |
| | 30A 125/250V Non-NEMA | | 3P/3W | Yellow | HBL28W08 | HBL29W08 | HBL69W08 | — |
| | 30A 3ØY 120/208V AC Non-NEMA | | 4P/4W | Yellow | HBL28W09 | HBL29W09 | — | — |



NSF UL SP
UL Type 4, 4X, 6P
IP65, 66, 67
SUITABILITY



Note: *Duplex receptacles available end of 2nd quarter 2015.

ACCESSORIES



HBL6500



HBL28W75IN



HBL29W75IN



HBLWTCS2



HBLWTB1



HBL50W50



UL Type 4X

IP65, 66, 67
SUITABILITY

Ordering Information

UL Type 4X Watertight Lift Covers

| | Description | Receptacle with Lift Cover |
|---------------------|--|----------------------------|
| Lift Cover Assembly | For use with 15A or 20A straight blade receptacles and 15A Twist-Lock® receptacles; receptacle not included. | HBL6500 |
| | For use with 20A Twist-Lock® receptacles; receptacle not included. | HBL6700 |
| | Note: When mating with HBL26W09 , 20A Non-NEMA plug, use HBL6800 cover. | |
| | For use with 30A Twist-Lock® receptacles; receptacle not included. | HBL6800 |

Interiors

| | Device | 125V | | 3Ø 250V AC | | 3Ø 480V AC | |
|-----|------------------------|-------------------|-------------------|-------------------|-------------------|-------------------|-------------------|
| | | Plug | Receptacle | Plug | Receptacle | Plug | Receptacle |
| 15A | Straight Blade Locking | HBL14W47IN | HBL15W47IN | — | — | — | — |
| | | HBL24W47IN | — | — | — | — | — |
| 20A | Locking | — | HBL27W47IN | HBL26W75IN | — | HBL26W76IN | HBL27W76IN |
| 30A | Locking | — | — | HBL28W75IN | HBL29W75IN | HBL28W76IN | HBL29W76IN |

Bushings, Cone Seals and Closure Caps

| | Device | Bushings | Cone Seals | Closure Caps | |
|-----|------------------------|----------------|-----------------|-----------------|-------------------|
| | | | | Yellow | Black |
| 15A | Straight Blade Locking | HBLWTB1 | HBLWTCS1 | HBL50W50 | HBL50W50BK |
| | | HBLWTB1 | HBLWTCS1 | HBL50W50 | HBL50W50BK |
| 20A | Straight Blade Locking | HBLWTB1 | HBLWTCS1 | HBL50W50 | HBL50W50BK |
| | | HBLWTB2 | HBLWTCS2 | HBL50W52 | HBL50W52BK |
| 30A | Locking | HBLWTB3 | HBLWTCS3 | HBL50W54 | HBL50W54BK |



FD BOXES AND ANGLED ADAPTERS

Introducing a fully UL Listed surface mount box engineered with features that allow easy, code compliant installation of all types of devices from 15A to 50A, including metallic ground bonding bracket, threaded conduit hubs and external mounting supports. Together with an industry first 55 degree angle adapter, the combination of devices is the only code compliant 45 cu.in. solution for 50A 4 wire installations. The angle adapter can also be installed separately for panel applications.

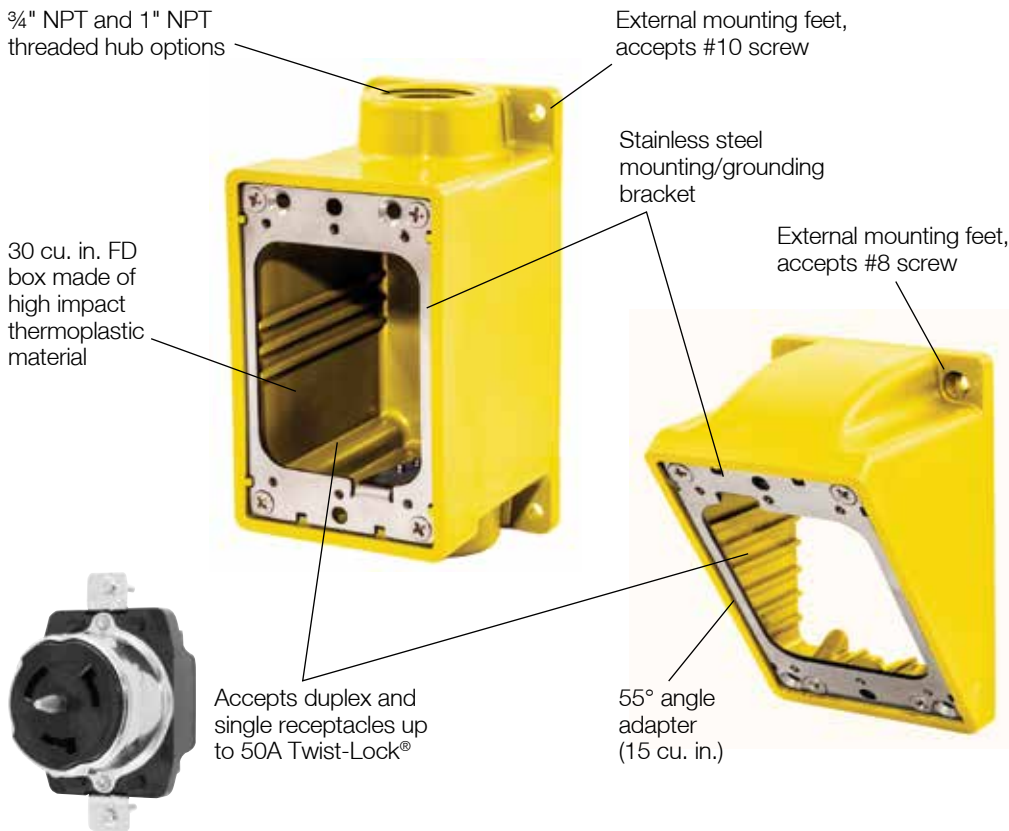

UL Type 4X
IP65, 66
SUITABILITY



HBL60CM83A



HBL60CM55



HBL60CM88



HBLP14FS



HBL60CM88W

Ordering Information

FD Boxes and Angled Adapters*

| | Description | Catalog Number |
|-----------------|--|---------------------|
| Boxes | (2) 3/4" NPT Hubs, FD Box, Yellow | HBL60CM83A |
| | (2) 3/4" NPT Hubs, FD Box, White | HBL60CM83WA |
| | (2) 3/4" NPT Hubs, FD Box, Gray | HBL6083 |
| | (2) 1" NPT Hubs, FD Box, Yellow | HBL60CM84A |
| | (2) 1" NPT Hubs, FD Box, White | HBL60CM84WA |
| | (2) 1" NPT Hubs, FD Box, Gray | HBL6084 |
| Adapters | 55° Angle Adapter, Yellow | HBL60CM55 |
| | 55° Angle Adapter, White | HBL60CM55W |
| | 55° Angle Adapter, Gray | HBL6055 |
| Kits | (2) 3/4" NPT Hubs, Box/Adapter Kit, Yellow | HBL60CM83AK |
| | (2) 3/4" NPT Hubs, Box/Adapter Kit, White | HBL60CM83WAK |
| | (2) 3/4" NPT Hubs, Box/Adapter Kit, Gray | HBL6083AK |
| | (2) 1" NPT Hubs, Box/Adapter Kit, Yellow | HBL60CM84AK |
| | (2) 1" NPT Hubs, Box/Adapter Kit, White | HBL60CM84WAK |
| | (2) 1" NPT Hubs, Box/Adapter Kit, Gray | HBL6084AK |
| Covers | Blank Cover Plate, Yellow | HBL60CM88 |
| | Blank Cover Plate, White | HBL60CM88W |
| | Blank Cover Plate, Gray | HBLP14FS |

Note: *Adapters available end of 2nd quarter 2015. Not UL listed, nor UL Type 4X.



PORTABLE OUTLET BOXES

Wiring room large enough to accommodate the broadest range of device requirements in one size box

Cord entry options include pre-defined range or "Build your own option"

Fully thermoplastic elastomer housing exceeds UL crush requirements and is highly impact resistant, available in black or yellow

Brass inserts for maximum strength

Extended wall protects lift covers from impact damage

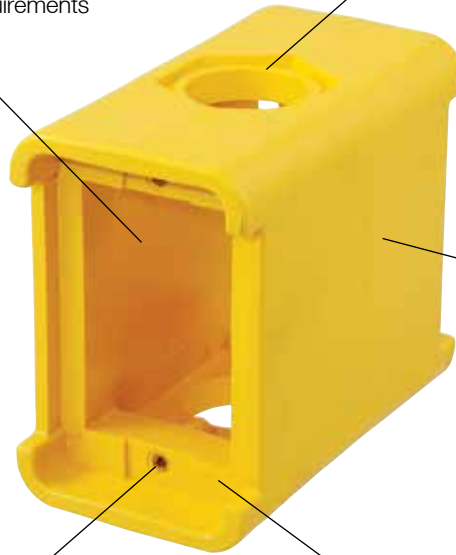

Box Suitable for Wet and Damp Locations

IP44
SUITABILITY



Ordering Information

Pre-Assembled Portable Outlet Boxes (with Cord Connector Installed)

| | Description | Cord Range Inches (mm) | Catalog Number |
|-------|--|------------------------|-----------------|
| Boxes | Portable Outlet Box, Deep, Yellow | .38"-.50" (9.7-12.7) | HBL3099 |
| | Portable Outlet Box, Deep, Feed Thru, Yellow | .38"-.50" (9.7-12.7) | HBL3090F |
| | Portable Outlet Box, Deep, Yellow with (2) duplex plates | .38"-.50" (9.7-12.7) | HBL3000 |

Configurable Portable Outlet Boxes

| | Empty Box Options | Catalog Number | Cord Range Inches (mm) | Cord Connector Options | | Deluxe Cord Connectors | |
|-------|-----------------------|-------------------|------------------------|------------------------|------------------|------------------------|------------------|
| | | | | Gray Nylon | Black Nylon | | |
| Boxes | Outlet Box, Yellow | HBL3080 | .38"-.50" (9.5-12.7) | SHC1039CR | — | — | |
| | Outlet Box, Black | HBL3080BK | .50"-.63" (12.7-15.9) | SHC1040CR | SHC2040CR | CG810NM | |
| | Feed Thru Box, Yellow | HBL3080F | .63"-.75" (15.9-19.0) | SHC1041CR | SHC2041CR | 074011341 | |
| | Feed Thru Box, Black | HBL3080FBK | .75"-.88" (19.0-22.2) | SHC1042CR | SHC2042CR | 074011342 | |
| | | | | .88"-1.00" (22.2-25.4) | SHC1043CR | SHC2043CR | 074011343 |
| | | | | .59"-1.00" (15.0-25.4) | SEC100GA | SEC100BA | — |

Note: Includes Locknut.



COVER PLATES FOR PORTABLE OUTLET BOXES AND PANELS

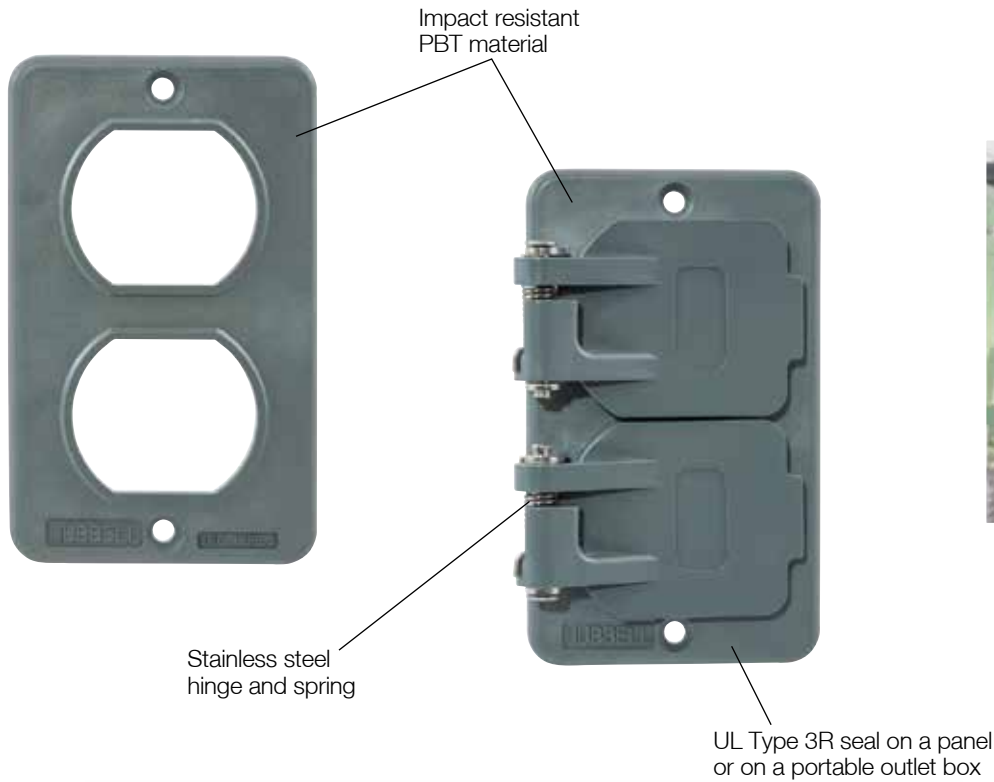

UL **SF**
UL Type 3R
IP44
SUITABILITY



UL Type 1



Ordering Information

Cover Plates for Portable Outlet Boxes and Panels

| | Description | UL Type 3R | UL Type 1 |
|--------------|--|----------------|----------------|
| Cover Plates | Outlet box cover, duplex receptacle | HBL3056 | HBL3051 |
| | Outlet box cover, 1.39" diameter receptacle | HBL3057 | HBL3052 |
| | Outlet box cover, 1.572" diameter receptacle | HBL3058 | HBL3055 |
| | Outlet box cover; GFCI | HBL3061 | HBL3060 |
| | Outlet box coverplate, blank | HBL3054 | — |

SPECIFICATIONS

Materials

Plug/Connector

| Part | Materials |
|-----------------------|---|
| Blade/Contact Carrier | Nylon, white |
| Terminal Retainer | Polycarbonate, clear |
| Housing | Thermoplastic elastomer |
| Housing Insert | Nylon, white |
| Strain Relief Nut | PBT thermoplastic, gray |
| Blades/Contacts | Brass, nickel plated |
| Terminal Screws | Brass |
| Terminal Screw Size | #8-32 15A/20A Straight Blade and 15A Twist-Lock; #10-32 20A and 30A Twist-Lock |
| Assembly Screws | Stainless Steel |
| Bushings | Thermoplastic elastomer, black |
| Gotcha Ring | Nylon |
| Cone Seal | Thermoplastic elastomer, black |
| Closure Cap | Thermoplastic elastomer |

Receptacle Assembly

| Part | Materials |
|-------------------------------|-------------------------|
| Base, Flip Lid, and Backplate | PBT |
| Seal Collar | Thermoplastic elastomer |
| Mounting Screws | Stainless Steel |
| Spring and Hinge Pin | Stainless Steel |

Portable Outlet Box and Accessories

| Part | Materials |
|--------------------|-------------------------|
| Box Enclosure | Thermoplastic elastomer |
| Strain Relief Nut | PBT |
| Grommet | Thermoplastic elastomer |
| Gotcha Ring | Nylon |
| Locknut | Steel, zinc plate |
| Threaded Inserts | Brass |
| Receptacle Screw | Stainless steel |
| Cover Plate | PBT |
| Cover Plate Seal | Neoprene |
| Cover Plate Spring | Stainless steel |
| Hinge Pin | Stainless steel |
| Hinge Bracket | Zinc plated steel |
| Rivets | Zinc plated steel |

Performance

Electrical

| | |
|----------------------|--|
| Dielectric Voltage | |
| Connectors: | 2000V AC if rated 300V or less; 3000V AC if rated above 300V |
| Plugs: | 2500V AC if rated 300V or less; 3500V AC if rated above 300V |
| Max Working Voltage | As marked |
| Current Interrupting | Rated for current interruption per UL498 |
| Temperature Rise | 30°C max per UL498 at rated current |

Mechanical

Cord and terminal accommodations:

Plugs and Connectors

| | |
|---|--|
| 15 and 20A Straight Blade and 15A Locking | 16/3 SJ to 10/3 SJ, 18/3 S to 12/3 S, (Ø.325" to Ø625") (Ø8.3mm to Ø15.9 mm) |
| 20A Locking Except HBL26W09 & HBL27W09 | Min. Cord: 16/3 SJ, 18/3 S, 18/4 SJ, 18/4 S, 18/5 S, (Ø.325") (Ø8.3 mm) Max. Cord: 10/3 S, 10/4 S, 10/5 S (.875") (22.2 mm) |
| 30A Locking Including HBL26W09 & HBL27W09 | Min Cords: 12/3 SJ, 16/3 S, 14/4 SJ, 18/4 S, 18/5 S, (Ø.375") (Ø9.5 mm) Max Cord: 8/3 S, 8/4 S, 10/5 S (1.125") (28.6 mm) |

Receptacles – use solid or stranded building wire or flexible cord only as outlined below:

| | |
|---------------------|------------------|
| All Straight Blade | 18 AWG to 10 AWG |
| 15A Locking | 18 AWG to 10 AWG |
| 20A and 30A Locking | 18 AWG to 8 AWG |

Portable Outlet Boxes

| | |
|---------------|---|
| Cord Range | .38" to .68" (HBL3099, HBL3090F, HBL3000) .38" to 1.00" with user-specified cord connector |
| Wiring Volume | 19.0 in ³ |

Environmental

| | |
|------------------------|---|
| Moisture Resistance | UL Listed to 3R, 3RX, 4, 4X, 6, 6P, 12 (Plugs and connectors); 3R, 3RX, 4, 4X (Receptacles); Wet and Damp Locations (Portable outlet boxes); Covers (POB) UL Type 3R and Wet Locations cover closed |
| Flammability | UL94V0 (boxes, covers, and plates); UL94V2 (Plugs, connectors, and interiors); UL94HB (Caps, bushings, and cone seals) |
| Operating Temperatures | -40°C (without impact) to +60°C continuous |
| UV Resistance | All exposed materials are UV stabilized |

Specifications

Listings (Plug/Connector and Flip Lid Assembly)

Listed to UL498
 Certified to CSA C22.2 No. 42
 Meets NEMA WD-1, WD-6, and ANSI standards
 IP66 Suitability
 NSF Certified (Plugs, Connectors and Receptacles)

FD Box/Adapter

| Part | Materials |
|----------------|---------------------|
| Box Enclosure | PBT |
| Ground Bracket | 316 Stainless Steel |
| Ground Screw | Brass |
| Angle Adapter | PBT |

Environmental

| | |
|-----|--|
| Box | UL Type 4X (with UL Type 4X receptacle assembly) UL Type 3R (with weatherproof cover plate) |
|-----|--|

DIMENSIONS

Plugs and Connectors Inches (mm)

| | | 15A & 20A Straight Blade | 15A Non-NEMA Straight Blade | 15A Twist-Lock® | 20A Twist-Lock® | 30A Twist-Lock® |
|------------|----------|-----------------------------|--------------------------------|--------------------|--------------------|--------------------|
| Plugs | A | 1.85 (47.07) | 1.63 (41.40) | 1.85 (47.07) | 2.51 (63.70) | 2.77 (70.41) |
| | B | 3.16 (80.27) | 2.68 (68.00) | 3.21 (81.46) | 3.96 (100.69) | 3.94 (99.98) |
| Connectors | C | 1.85 (47.07) | 1.80 (46.00) | 1.85 (47.07) | 2.51 (63.70) | 2.77 (70.41) |
| | D | 4.42 (112.14) | 4.00 (102.00) | 4.62 (117.22) | 5.69 (144.55) | 5.67 (144.00) |

Note: For HBL26W09 and HBL27W09 use 30A Twist-Lock® dimensions.

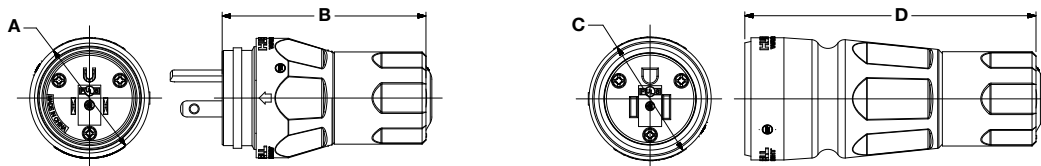

Receptacles with Lift Covers Inches (mm)

| | 15A & 20A Straight Blade | 15A Twist-Lock® | 20A Twist-Lock® | 20A Non-NEMA | 30A Twist-Lock® | 30A Non-NEMA |
|----------|-----------------------------|--------------------|--------------------|-----------------|--------------------|-----------------|
| A | 4.56" (115.9) | 4.56" (115.9) | 4.56" (115.9) | 4.56" (115.9) | 4.56" (115.9) | 4.56" (115.9) |
| B | 3.10" (78.7) | 3.10" (78.7) | 3.10" (78.7) | 3.10" (78.7) | 3.10" (78.7) | 3.10" (78.7) |
| C | 1.20" (30.6) | 1.20" (30.6) | 1.20" (30.6) | 1.20" (30.6) | 1.20" (30.6) | 1.20" (30.6) |
| D | 3.25" (82.6) | 3.25" (82.6) | 3.25" (82.6) | 3.25" (82.6) | 3.25" (82.6) | 3.25" (82.6) |
| E | 1.88" (47.6) | 1.88" (47.6) | 1.88" (47.6) | 1.88" (47.6) | 1.88" (47.6) | 1.88" (47.6) |
| F | 1.26" (32.0) | 1.46" (37.1) | 1.72" (43.7) | 2.26" (57.4) | 1.72" (43.7) | 1.97" (50.0) |
| G | 1.63" (41.4) | 1.63" (41.4) | 2.25" (57.2) | 2.25" (57.2) | 2.25" (57.2) | 2.25" (57.2) |
| H | 5.00" (127.0) | 5.00" (127.0) | 5.00" (127.0) | 5.00" (127.0) | 5.00" (127.0) | 5.00" (127.0) |

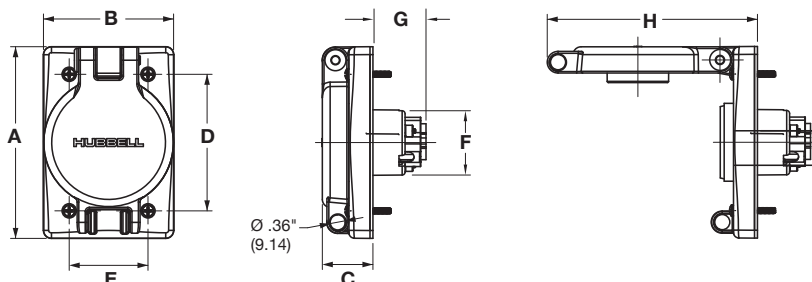

Portable Outlet Boxes Inches (mm)

| | Pre-Assembled | Configurable |
|----------|---------------|---------------|
| A | 4.30" (109.2) | 4.30" (109.2) |
| B | 5.00" (127.0) | 5.00" (127.0) |
| C | 2.77" (70.4) | 2.77" (70.4) |
| D | 3.28" (83.3) | 3.28" (83.3) |
| E | 5.79" (147.0) | — |
| F | 7.28" (184.9) | — |

Cover Plates Inches (mm)

| | |
|----------|--------------|
| A | 3.78" (96.0) |
| B | 2.28" (57.9) |
| C | 0.27" (6.9) |
| D | 3.28" (83.3) |
| E | 1.87" (47.5) |
| F | 3.25" (82.6) |

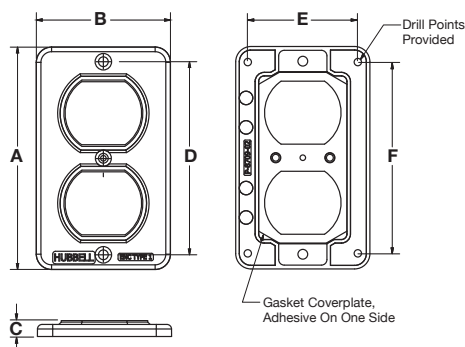
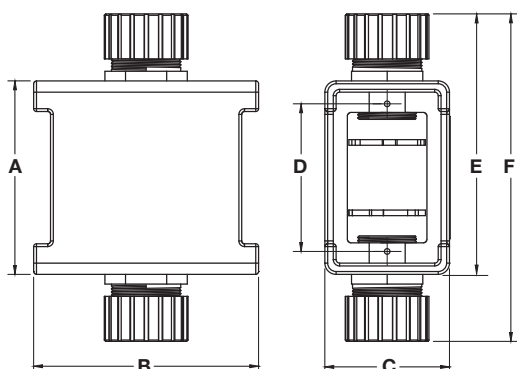

Style shown is representative of all openings.

WATERTIGHT WIRING DEVICES

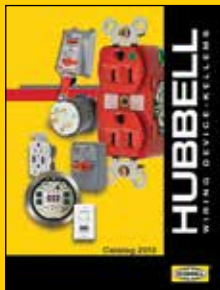

2013 Full Line Catalog

The new Hubbell Wiring Device-Kellems catalog showcases our enhanced product offering to provide a breadth of solutions for the industrial, commercial and residential markets.



Hubbell Safety Brochure

Hubbell has always been focused on safety. That's why Hubbell products are designed and developed to first provide maximum safety against injury and the potential dangers of electricity.

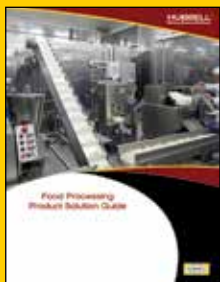

Hubbell Food Processing Brochure

Hubbell's food processing guide identifies Wiring Device-Kellems product solutions for areas where water, corrosiveness, harsh temperature and personal protection are required. Food processing is a demanding environment and Hubbell has the right products to keep production moving safely.

Twist-Lock® App

When you're on the go... Use the New Twist-Lock® App from Hubbell®.



Download it today!



X-ON Electronics

Largest Supplier of Electrical and Electronic Components

Click to view similar products for [hubbell](#) manufacturer:

Other Similar products are found below :

[CFB7TALU](#) [03301045](#) [02216024](#) [03301047](#) [5369VY](#) [5461](#) [WSS1P](#) [00322005LPK50](#) [01304055](#) [M001SG000](#) [M001SG00P](#) [M11MSP](#)
[01301013](#) [02201005](#) [02202008](#) [02203007](#) [02203064](#) [02206012](#) [02211003](#) [02211019](#) [02402005](#) [02406006](#) [02407008](#) [CS1223GY](#) [CS6360C](#)
[CS6370](#) [7310](#) [MCMA14110](#) [7485VBLK](#) [7585](#) [7716](#) [7967](#) [FF3I](#) [PF2004PA005](#) [PFOLT312](#) [PH2003PA010](#) [PH2304PB050](#) [PH6598W](#) [9308](#)
[GFP2305](#) [GFR5352IA](#) [GFR5362WTR](#) [GFR8300SNAPBKNA](#) [PM3004PA015](#) [HBL13R12D](#) [HBL16LEDR](#) [HBL18201WCN](#)
[HBL20GBA612IV](#) [HBL20IG606GY](#) [HBL2441](#)